

**Acura**

**CSX 4 Door Sedan ..... 2006-2011**  
(CANADA Only)

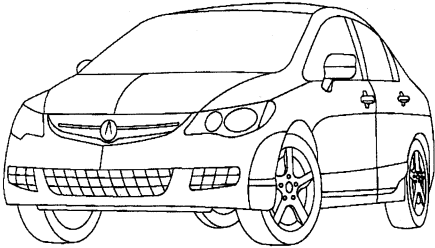

|  |                  |
|--|------------------|
| <b>FW02584<sup>a b</sup></b> Windshield (Solar) (W/Third Visor Frit) ..... | <b>43.8x54.0</b> |
| <b>FD22693-94</b> Door F/R-L (Solar) .....                                 | <b>16.9x42.6</b> |
| <b>FD22695-96</b> Door R/R-L (Solar) .....                                 | <b>18.0x27.5</b> |
| <b>FV22855-56<sup>d</sup></b> Vent F/R-L (Solar) .....                     | <b>7.5x10.0</b>  |
| <b>FV22697-98</b> Vent R/R-L (Solar) .....                                 | <b>7.0x10.0</b>  |
| <b>FB22699<sup>c</sup></b> Back Window (Ant)(Heated)(Solar) .....          | <b>30.0x48.5</b> |

<sup>a</sup> Urethane,Dam,Primer - 2 Tubes  
<sup>b</sup> Fast-Cure Urethane/Dam/Primer - Quantity 2  
<sup>c</sup> Urethane,Dam,Primer - 1.5 Tubes  
<sup>d</sup> Urethane,Dam,Primer - 1 Tube

**MDX 4 Door Utility ..... 2007-2011**

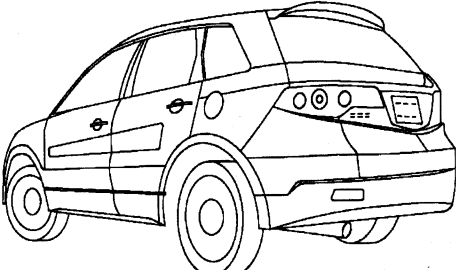

|  |                  |
|--|------------------|
| <b>FW03256<sup>a c d</sup></b> Windshield (Solar) (Electrochromic Mirror, Aftermarket) .....         | <b>40.7x61.4</b> |
| <b>FW03255<sup>a c d</sup></b> Windshield (Solar) (Aftermarket) .....                                | <b>40.7x61.4</b> |
| <b>FW02703<sup>b c d</sup></b> Windshield (Solar) (Electrochromic Mirror, Acoustic Interlayer) ..... | <b>40.7x61.4</b> |
| <b>FW02702<sup>b c d</sup></b> Windshield (Solar) (Acoustic Interlayer) .....                        | <b>40.7x61.4</b> |
| <b>FD23260-61</b> Door F/R-L (Solar) .....   | <b>26.3x34.0</b> |
| <b>FD23262-63</b> Door R/R-L (Solar) .....   | <b>18.5x29.0</b> |
| <b>FQ23264-65<sup>f</sup></b> Quarter R-L (Encap)(Solar) .....                                       | <b>15.5x24.0</b> |
| <b>FB23266<sup>e</sup></b> Back Window (Heated)(1 Holes)(Solar) (W/Wiper) ...                        | <b>19.0x62.0</b> |

<sup>a</sup> Not On Production Vehicles  
<sup>b</sup> On Production Vehicles  
<sup>c</sup> Urethane,Dam,Primer - 2 Tubes  
<sup>d</sup> Fast-Cure Urethane/Dam/Primer - Quantity 2  
<sup>e</sup> Urethane,Dam,Primer - 1.5 Tubes  
<sup>f</sup> Urethane,Dam,Primer - 1 Tube

**MDX 4 Door Utility ..... 2006**

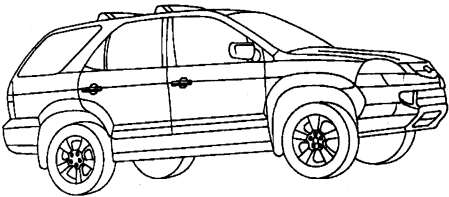

|  |                  |
|--|------------------|
| <b>FW02852<sup>a c d f</sup></b> Windshield (Solar) (Aftermarket, Rain Sensor) .....       | <b>40.1x63.8</b> |
| <b>FW02851<sup>a c d</sup></b> Windshield (Solar) (Aftermarket) .....                      | <b>40.1x63.8</b> |
| <b>FW02437<sup>b c d</sup></b> Windshield (Solar) (Acoustic Interlayer, Rain Sensor) ..... | <b>40.1x63.8</b> |
| <b>FW02436<sup>b c d</sup></b> Windshield (Solar) (Acoustic Interlayer) .....              | <b>40.1x63.8</b> |
| <b>FD21050-51</b> Door F/R-L (Solar) .....   | <b>21.5x38.3</b> |
| <b>FD21052-53</b> Door R/R-L (Solar) .....   | <b>21.9x26.4</b> |
| <b>FQ24716<sup>g</sup></b> Quarter R (Ant)(Encap)(Solar) .....                             | <b>18.0x24.0</b> |
| <b>FQ21056-57<sup>g</sup></b> Quarter R-L (Encap)(Solar) .....                             | <b>18.0x24.0</b> |
| <b>FV21054-55</b> Vent R/R-L (Solar) .....   | <b>9.1x12.1</b>  |
| <b>FB21058<sup>e</sup></b> Back Window (Heated)(Solar) .....                               | <b>18.0x40.0</b> |

<sup>a</sup> Not On Production Vehicles  
<sup>b</sup> On Production Vehicles  
<sup>c</sup> Urethane,Dam,Primer - 2 Tubes  
<sup>d</sup> Fast-Cure Urethane/Dam/Primer - Quantity 2  
<sup>e</sup> Urethane,Dam,Primer - 1.5 Tubes  
<sup>f</sup> Rain Sensor Kit  
<sup>g</sup> Urethane,Dam,Primer - 1 Tube

**RDX 4 Door Utility ..... 2007-2011**

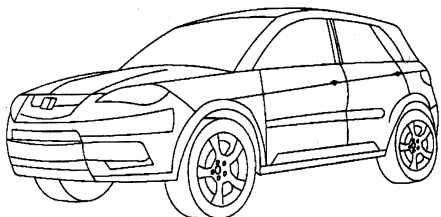

|   |                  |
|---|------------------|
| <b>FW02767<sup>a b</sup></b> Windshield (Solar) (Electrochromic Mirror) (08-11) ... | <b>40.3x60.1</b> |
| <b>FW02694<sup>a b</sup></b> Windshield (Solar) (07) .....                          | <b>40.3x60.1</b> |
| <b>FD23238-39</b> Door F/R-L (Solar) .....  | <b>22.0x39.5</b> |
| <b>FD23240-41</b> Door R/R-L (Solar) .....  | <b>19.5x27.3</b> |
| <b>FQ23242-43<sup>c</sup></b> Quarter R-L (Solar) .....                             | <b>13.9x19.4</b> |
| <b>FB23244<sup>a</sup></b> Back Window (Heated)(1 Holes)(Solar) (W/Wiper) ...       | <b>22.0x61.5</b> |

<sup>a</sup> Urethane,Dam,Primer - 2 Tubes  
<sup>b</sup> Fast-Cure Urethane/Dam/Primer - Quantity 2  
<sup>c</sup> Urethane,Dam,Primer - 1 Tube

**RL 4 Door Sedan ..... 2009-2011**

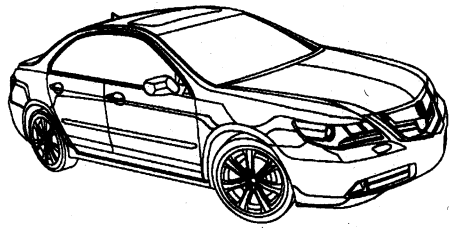

|   |                  |
|---|------------------|
| <b>FW03276<sup>a c d</sup></b> Windshield (Solar) (W/Third Visor Frit, Aftermarket) .....         | <b>39.0x60.0</b> |
| <b>FW02998<sup>b c d</sup></b> Windshield (Solar) (W/Third Visor Frit, Acoustic Interlayer) ..... | <b>39.0x60.0</b> |
| <b>FD24008-09</b> Door F/R-L (Solar) .....  | <b>19.0x36.0</b> |
| <b>FD24010-11</b> Door R/R-L (Solar) .....  | <b>19.0x26.0</b> |

**RL (cont.)**

|   |                  |
|---|------------------|
| <b>FV24012-13</b> Vent R/R-L (Solar) .....                        | <b>10.5x11.5</b> |
| <b>FB24014<sup>e</sup></b> Back Window (Ant)(Heated)(Solar) ..... | <b>29.0x52.0</b> |

<sup>a</sup> Not On Production Vehicles  
<sup>b</sup> On Production Vehicles  
<sup>c</sup> Urethane,Dam,Primer - 2 Tubes  
<sup>d</sup> Fast-Cure Urethane/Dam/Primer - Quantity 2  
<sup>e</sup> Urethane,Dam,Primer - 1.5 Tubes

**RL 4 Door Sedan ..... 2006-2008**

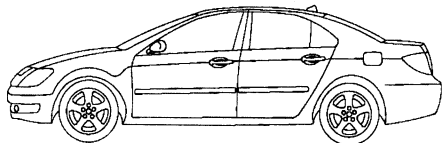

|   |                  |
|---|------------------|
| <b>FW02522<sup>a b</sup></b> Windshield (Solar) (W/Third Visor Frit) .....                              | <b>42.7x59.3</b> |
| <b>FD22516-17</b> Door F/R-L (Solar) .....  | <b>18.0x33.0</b> |
| <b>FD22518-19</b> Door R/R-L (Solar) .....  | <b>18.5x24.5</b> |
| <b>FV22520-21</b> Vent R/R-L (Solar) .....  | <b>10.0x11.0</b> |
| <b>FB22602<sup>c</sup></b> Back Window (Ant)(Heated)(Solar) (W/Keyless Entry) .....                     | <b>28.5x51.0</b> |
| <b>FB22522<sup>c</sup></b> Back Window (Ant)(Heated)(Solar) (XM Satellite Radio, W/Keyless Entry) ..... | <b>28.5x51.0</b> |

<sup>a</sup> Urethane,Dam,Primer - 2 Tubes  
<sup>b</sup> Fast-Cure Urethane/Dam/Primer - Quantity 2  
<sup>c</sup> Urethane,Dam,Primer - 1.5 Tubes

**RSX 2 Door Coupe ..... 2006**

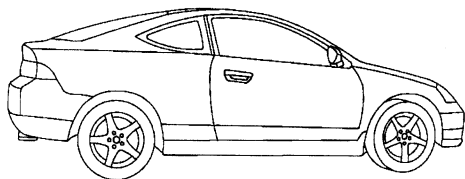

|  |                  |
|--|------------------|
| <b>FW02270<sup>a b</sup></b> Windshield (Solar) .....                      | <b>38.6x56.5</b> |
| <b>FD21423-24</b> Door F/R-L (Solar) .....                                 | <b>17.0x41.0</b> |
| <b>FQ21425-26<sup>c</sup></b> Quarter R-L (Encap)(Solar) .....             | <b>14.5x26.0</b> |
| <b>FB21427<sup>a</sup></b> Back Window (Ant)(Heated)(1 Holes)(Solar) ..... | <b>41.3x50.0</b> |

<sup>a</sup> Urethane,Dam,Primer - 2 Tubes  
<sup>b</sup> Fast-Cure Urethane/Dam/Primer - Quantity 2  
<sup>c</sup> Urethane,Dam,Primer - 1 Tube

**TL 4 Door Sedan ..... 2009-2011**

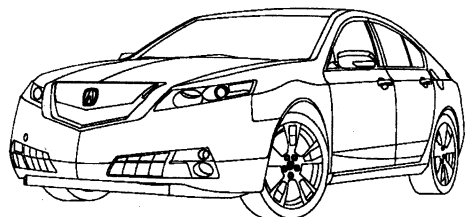

|   |                  |
|---|------------------|
| <b>FW03263<sup>a c d</sup></b> Windshield (Solar) (Aftermarket) .....         | <b>37.4x59.4</b> |
| <b>FW02930<sup>b c d</sup></b> Windshield (Solar) (Acoustic Interlayer) ..... | <b>37.4x59.4</b> |
| <b>FD23799-00</b> Door F/R-L (Solar) .....                                    | <b>19.0x34.0</b> |
| <b>FD23801-02</b> Door R/R-L (Solar) .....                                    | <b>18.0x24.0</b> |
| <b>FV23803-04</b> Vent R/R-L (Solar) .....                                    | <b>11.0x12.0</b> |
| <b>FB23805<sup>e</sup></b> Back Window (Heated)(Solar) .....                  | <b>26.5x48.0</b> |

<sup>a</sup> Not On Production Vehicles

**TL (cont.)**

<sup>b</sup> On Production Vehicles  
<sup>c</sup> Urethane,Dam,Primer - 2 Tubes  
<sup>d</sup> Fast-Cure Urethane/Dam/Primer - Quantity 2  
<sup>e</sup> Urethane,Dam,Primer - 1.5 Tubes

**TL 4 Door Sedan ..... 2006-2008**

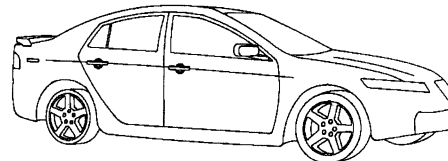

|   |                  |
|---|------------------|
| <b>FW02758<sup>a c d</sup></b> Windshield (Solar) (Aftermarket) .....         | <b>39.0x60.0</b> |
| <b>FW02452<sup>b c d</sup></b> Windshield (Solar) (Acoustic Interlayer) ..... | <b>39.0x60.0</b> |
| <b>FD22223-24</b> Door F/R-L (Solar) .....                                    | <b>19.0x33.5</b> |
| <b>FD22225-26</b> Door R/R-L (Solar) .....                                    | <b>19.0x23.8</b> |
| <b>FV22227-28</b> Vent R/R-L (Solar) .....                                    | <b>8.0x12.0</b>  |
| <b>FB22229<sup>e</sup></b> Back Window (Ant)(Heated)(Solar) .....             | <b>28.5x50.3</b> |

<sup>a</sup> Not On Production Vehicles  
<sup>b</sup> On Production Vehicles  
<sup>c</sup> Urethane,Dam,Primer - 2 Tubes  
<sup>d</sup> Fast-Cure Urethane/Dam/Primer - Quantity 2  
<sup>e</sup> Urethane,Dam,Primer - 1.5 Tubes

**TSX 4 Door Sedan ..... 2009-2011**

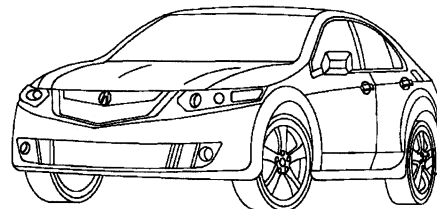

|   |                  |
|---|------------------|
| <b>FW03268<sup>a c d</sup></b> Windshield (Solar) (Aftermarket) .....         | <b>37.0x56.0</b> |
| <b>FW02994<sup>b c d</sup></b> Windshield (Solar) (Acoustic Interlayer) ..... | <b>37.0x56.0</b> |
| <b>FD23996-97</b> Door F/R-L (Solar) .....                                    | <b>19.0x38.0</b> |
| <b>FD23998-99</b> Door R/R-L (Solar) .....                                    | <b>16.8x24.5</b> |
| <b>FV24000-01</b> Vent R/R-L (Solar) .....                                    | <b>9.0x10.0</b>  |
| <b>FB24002<sup>e</sup></b> Back Window (Ant)(Heated)(Solar) .....             | <b>29.5x50.5</b> |

<sup>a</sup> Not On Production Vehicles  
<sup>b</sup> On Production Vehicles  
<sup>c</sup> Urethane,Dam,Primer - 2 Tubes  
<sup>d</sup> Fast-Cure Urethane/Dam/Primer - Quantity 2  
<sup>e</sup> Urethane,Dam,Primer - 1.5 Tubes

**TSX 4 Door Sedan ..... 2006-2008**

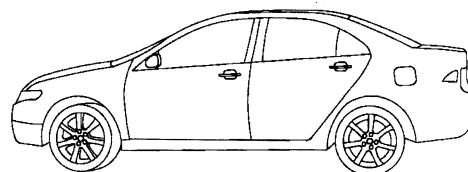

|   |                  |
|---|------------------|
| <b>FW02388<sup>a b</sup></b> Windshield (Solar) ..... | <b>38.0x55.0</b> |
| <b>FD21921-22</b> Door F/R-L (Solar) .....            | <b>19.0x33.5</b> |
| <b>FD21923-24</b> Door R/R-L (Solar) .....            | <b>19.0x25.2</b> |
| <b>FV21925-26</b> Vent R/R-L (Solar) .....            | <b>10.0x10.0</b> |

| TSX  | (cont.)   |
|--|---|
| FB21927 <sup>c</sup>                                     | Back Window (Ant)(Heated)(Solar) ..... 31.5x49.5  |
| <sup>a</sup>   | Urethane,Dam,Primer - 2 Tubes   |
| <sup>b</sup>   | Fast-Cure Urethane/Dam/Primer - Quantity 2  |
| <sup>c</sup>   | Urethane,Dam,Primer - 1.5 Tubes   |
| <b>ZDX 4 Door Utility ..... 2010-2011</b>                |   |
|  |   |
| FW03325 <sup>a c d</sup>                                 | Windshield (Solar) (Electrochromic Mirror, Aftermarket) ..... 38.0x61.5                             |
| FW03159 <sup>b c d</sup>                                 | Windshield (Solar) (Electrochromic Mirror, W/Third Visor Frit, Acoustic Interlayer) ..... 38.0x61.5 |
| FD24439-40   | Door F/R-L (Solar) ..... 17.0x34.0  |
| FD24441-42   | Door R/R-L (Solar) ..... 15.0x19.5  |
| FR24521  | Roof F (Solar) ..... 7.0x34.5   |
| FR24523 <sup>e</sup>                                     | Roof R (Solar) ..... 34.5x36.0  |
| FR24522  | Roof C (Encap)(Solar) ..... 23.0x34.5   |
| FV24443-44   | Vent R/R-L (Solar) ..... 5.5x 9.0   |
| FB24446 <sup>f</sup>                                     | Back Window Lower (Heated)(Solar) ..... 6.5x42.5  |
| FB24445 <sup>e</sup>                                     | Back Window Upper (Heated)(Solar) ..... 32.0x41.5   |
| <sup>a</sup>   | Not On Production Vehicles  |
| <sup>b</sup>   | On Production Vehicles  |
| <sup>c</sup>   | Urethane,Dam,Primer - 2 Tubes   |
| <sup>d</sup>   | Fast-Cure Urethane/Dam/Primer - Quantity 2  |
| <sup>e</sup>   | Urethane,Dam,Primer - 1.5 Tubes   |
| <sup>f</sup>   | Urethane,Dam,Primer - 1 Tube  |
| <b>Alfa Romeo</b>  |   |
| <b>147 2 Door Hatchback (MEXICO Only)..... 2006-2009</b> |   |
| FW02868 <sup>a b d</sup>                                 | Windshield (Solar) (Mexico Only, Rain Sensor) .....   |
| FW02867 <sup>a b</sup>                                   | Windshield (Solar) (Mexico Only) .....  |
| FD23613-14   | Door F/R-L (Solar) (Mexico Only) .....  |
| FQ23615-16 <sup>c</sup>                                  | Quarter R-L (Encap)(Solar) (Mexico Only) .....  |
| FB23621 <sup>c</sup>                                     | Back Window (Heated)(1 Holes)(Solar) (Mexico Only)  |
| <sup>a</sup>   | Urethane,Dam,Primer - 2 Tubes   |
| <sup>b</sup>   | Fast-Cure Urethane/Dam/Primer - Quantity 2  |
| <sup>c</sup>   | Urethane,Dam,Primer - 1.5 Tubes   |
| <sup>d</sup>   | Rain Sensor Kit   |
| <b>147 4 Door Hatchback (MEXICO Only)..... 2006-2009</b> |   |
| FW02868 <sup>a b d</sup>                                 | Windshield (Solar) (Mexico Only, Rain Sensor) .....   |
| FW02867 <sup>a b</sup>                                   | Windshield (Solar) (Mexico Only) .....  |
| FD23617-18   | Door F/R-L (Solar) (Mexico Only) .....  |
| FD23619-20   | Door R/R-L (Solar) (Mexico Only) .....  |
| FB23621 <sup>c</sup>                                     | Back Window (Heated)(1 Holes)(Solar) (Mexico Only)  |
| <sup>a</sup>   | Urethane,Dam,Primer - 2 Tubes   |
| <sup>b</sup>   | Fast-Cure Urethane/Dam/Primer - Quantity 2  |
| <sup>c</sup>   | Urethane,Dam,Primer - 1.5 Tubes   |
| <sup>d</sup>   | Rain Sensor Kit   |
| <b>156 4 Door Sedan (MEXICO Only) ..... 2006</b>         |   |
| FW02853 <sup>a b</sup>                                   | Windshield (Mexico Only) .....  |
| FD23953-54   | Door F/R-L (Mexico Only) .....  |

| 156  | (cont.)  |
|--|--|
| FD23955-56   | Door R/R-L (Mexico Only) .....                                     |
| FB23957 <sup>c</sup>                                     | Back Window (Ant) (Mexico Only) .....                              |
| <sup>a</sup>   | Urethane,Dam,Primer - 2 Tubes                                      |
| <sup>b</sup>   | Fast-Cure Urethane/Dam/Primer - Quantity 2                         |
| <sup>c</sup>   | Urethane,Dam,Primer - 1.5 Tubes                                    |
| <b>156 4 Door Station Wagon (MEXICO Only)..... 2006</b>  |  |
| FW02853 <sup>a b</sup>                                   | Windshield (Mexico Only) .....                                     |
| FD23953-54   | Door F/R-L (Mexico Only) .....                                     |
| FD23958-59   | Door R/R-L (Mexico Only) .....                                     |
| FQ23960-61 <sup>c</sup>                                  | Quarter R-L (Encap) (Mexico Only) .....                            |
| FB23962 <sup>c</sup>                                     | Back Window (Mexico Only) .....                                    |
| <sup>a</sup>   | Urethane,Dam,Primer - 2 Tubes                                      |
| <sup>b</sup>   | Fast-Cure Urethane/Dam/Primer - Quantity 2                         |
| <sup>c</sup>   | Urethane,Dam,Primer - 1.5 Tubes                                    |
| <b>159 4 Door Sedan (MEXICO Only)..... 2006-2009</b>     |  |
| FW03050 <sup>a b d</sup>                                 | Windshield (Heated)(Solar) (Mexico Only, Rain Sensor) .....        |
| FW03049 <sup>a b</sup>                                   | Windshield (Heated)(Solar) (Mexico Only) .....                     |
| FW03048 <sup>a b d</sup>                                 | Windshield (Solar) (Mexico Only, Rain Sensor) .....                |
| FW03047 <sup>a b</sup>                                   | Windshield (Solar) (Mexico Only) .....                             |
| FD24154-55   | Door F/R-L (Solar) (Mexico Only) .....                             |
| FD24156-57   | Door R/R-L (Solar) (Mexico Only) .....                             |
| FB24158 <sup>c</sup>                                     | Back Window (Heated)(Solar) (Mexico Only) .....                    |
| <sup>a</sup>   | Urethane,Dam,Primer - 2 Tubes                                      |
| <sup>b</sup>   | Fast-Cure Urethane/Dam/Primer - Quantity 2                         |
| <sup>c</sup>   | Urethane,Dam,Primer - 1.5 Tubes                                    |
| <sup>d</sup>   | Rain Sensor Kit  |
| <b>Brera 2 Door Coupe (MEXICO Only)..... 2006-2009</b>   |  |
| FW03046 <sup>a b d</sup>                                 | Windshield (Encap)(Heated)(Solar) (Mexico Only, Rain Sensor) ..... |
| FW03045 <sup>a b d</sup>                                 | Windshield (Encap)(Solar) (Mexico Only, Rain Sensor) .....         |
| FW03044 <sup>a b</sup>                                   | Windshield (Encap)(Solar) (Mexico Only) .....                      |
| FD24149-50   | Door F/R-L (Solar) (Mexico Only) .....                             |
| FQ24151-52 <sup>c</sup>                                  | Quarter R-L (Encap)(Solar) (Mexico Only) .....                     |
| FB24153 <sup>c</sup>                                     | Back Window (Ant)(Encap)(Heated)(Solar) (Mexico Only) .....        |
| <sup>a</sup>   | Urethane,Dam,Primer - 2 Tubes                                      |
| <sup>b</sup>   | Fast-Cure Urethane/Dam/Primer - Quantity 2                         |
| <sup>c</sup>   | Urethane,Dam,Primer - 1.5 Tubes                                    |
| <sup>d</sup>   | Rain Sensor Kit  |
| <b>Spider 2 Door Convertible (MEXICO Only)..... 2006</b> |  |
| FW03043 <sup>a b</sup>                                   | Windshield (Solar) (Mexico Only) .....                             |
| FD24147-48   | Door F/R-L (Solar) (Mexico Only) .....                             |
| <sup>a</sup>   | Urethane,Dam,Primer - 2 Tubes                                      |
| <sup>b</sup>   | Fast-Cure Urethane/Dam/Primer - Quantity 2                         |
| <b>A3 2 Door Hatchback (MEXICO Only)..... 2006</b>       |  |
| FW02328 <sup>b</sup>                                     | Windshield (VIN Notch, Mexico Only) ..... 33.0x55.0                |
| FD21731-32   | Door F/R-L (Mexico Only) ..... 22.3x38.8                           |
| FQ21733-34 <sup>c</sup>                                  | Quarter R-L (1 Holes) (Mexico Only) ..... 16.7x32.0                |
| FB21741 <sup>a</sup>                                     | Back Window (Heated)(1 Holes) (Mexico Only) .....                  |

**A3** (cont.)

<sup>a</sup> High Modulus Urethane,Dam,Primer - 1.5 Tubes  
<sup>b</sup> High Modulus Urethane,Dam,Primer - 2 Tubes  
<sup>c</sup> High Modulus Urethane,Dam,Primer - 1 Tube

**A3 4 Door Hatchback**..... **2006-2010**

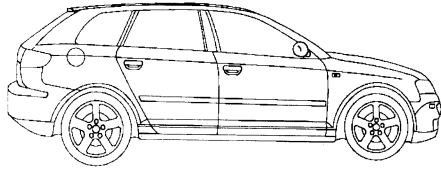

|                               |   |                  |
|-------------------------------|---|------------------|
| <b>FW03203<sup>b</sup></b>    | Windshield (Solar) (Acoustic Interlayer, Rain Sensor) (08-10) .....       | <b>35.0x60.0</b> |
| <b>FW03202<sup>b</sup></b>    | Windshield (Solar) (Acoustic Interlayer) (08-10) .....                    | <b>35.0x60.0</b> |
| <b>FW02580<sup>b</sup></b>    | Windshield (Solar) (Rain Sensor) .....                                    | <b>35.0x60.0</b> |
| <b>FW02579<sup>b</sup></b>    | Windshield (Solar) .....  | <b>35.0x60.0</b> |
| <b>FD22681-82</b>             | Door F/R-L (2 Holes)(Solar) .....   | <b>20.8x35.0</b> |
| <b>FD22683-84</b>             | Door R/R-L (2 Holes)(Solar) .....   | <b>19.8x27.0</b> |
| <b>FQ22685-86<sup>c</sup></b> | Quarter R-L (Encap)(Solar) .....  | <b>13.5x19.0</b> |
| <b>FB22687<sup>a</sup></b>    | Back Window (Ant)(Heated)(1 Holes)(Solar) (W/ Wiper, W/GPS Antenna) ..... | <b>21.0x46.8</b> |

<sup>a</sup> High Modulus Urethane,Dam,Primer - 1.5 Tubes  
<sup>b</sup> High Modulus Urethane,Dam,Primer - 2 Tubes  
<sup>c</sup> High Modulus Urethane,Dam,Primer - 1 Tube

**A4 2 Door Convertible**..... **2006-2009**  
**RS4 2 Door Convertible**..... **2008-2009**  
**S4 2 Door Convertible**..... **2006-2009**

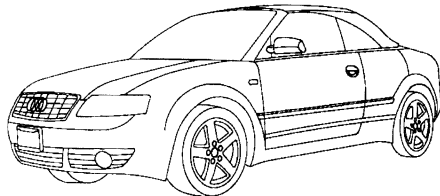

|                            |  |                  |
|----------------------------|--|------------------|
| <b>FW02839<sup>a</sup></b> | Windshield (Solar) (Rain Sensor) (07-09) ..... | <b>37.0x56.9</b> |
| <b>FW02368<sup>a</sup></b> | Windshield (Solar) (06-09) .....               | <b>37.0x56.9</b> |
| <b>FD21862-63</b>          | Door F/R-L (1 Holes) (06-09) .....             | <b>18.0x37.7</b> |
| <b>FQ21864-65</b>          | Quarter R-L (06-09) .....                      | <b>17.0x23.5</b> |

<sup>a</sup> High Modulus Urethane,Dam,Primer - 2 Tubes

**A4 4 Door Sedan**..... **2009-2011**  
**RS4 4 Door Sedan**..... **2009-2011**  
**S4 4 Door Sedan**..... **2009-2011**

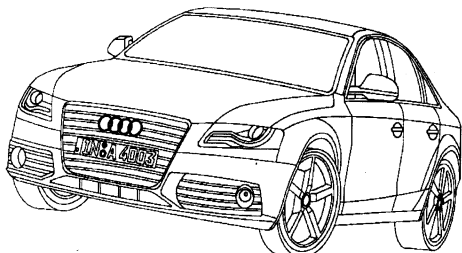

|                            |  |                  |
|----------------------------|--|------------------|
| <b>FW02948<sup>b</sup></b> | Windshield (Solar) (PAAS System, W/Lane Departure Warning System, Rain Sensor) ..... | <b>36.0x57.5</b> |
|----------------------------|--|------------------|

**A4** (cont.)

|                               |   |                  |
|-------------------------------|---|------------------|
| <b>FW02947<sup>b</sup></b>    | Windshield (Solar) (PAAS System, Rain Sensor) ..... | <b>36.0x57.5</b> |
| <b>FW02946<sup>b</sup></b>    | Windshield (Solar) (PAAS System) .....              | <b>36.0x57.5</b> |
| <b>FD23878-79</b>             | Door F/R-L (2 Holes)(Solar) .....                   | <b>18.5x29.0</b> |
| <b>FD23880-81</b>             | Door R/R-L (2 Holes)(Solar) .....                   | <b>18.5x27.0</b> |
| <b>FQ23884-85<sup>c</sup></b> | Quarter R-L (Encap)(Solar) (Chrome Moulding) .....  | <b>12.0x15.0</b> |
| <b>FQ23882-83<sup>c</sup></b> | Quarter R-L (Encap)(Solar) (Black Moulding) .....   | <b>12.0x15.0</b> |
| <b>FB23886<sup>a</sup></b>    | Back Window (Ant)(Heated)(Solar) .....              | <b>27.0x49.5</b> |

<sup>a</sup> High Modulus Urethane,Dam,Primer - 1.5 Tubes  
<sup>b</sup> High Modulus Urethane,Dam,Primer - 2 Tubes  
<sup>c</sup> High Modulus Urethane,Dam,Primer - 1 Tube

**A4 4 Door Sedan**..... **2006-2008**  
**RS4 4 Door Sedan**..... **2006-2008**  
**S4 4 Door Sedan**..... **2006-2008**

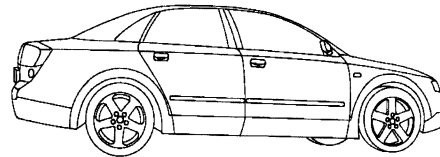

|                               |  |                  |
|-------------------------------|--|------------------|
| <b>FW02810<sup>a d</sup></b>  | Windshield (Solar) (Acoustic Interlayer, Aftermarket, Rain Sensor) (From 083001) ..... | <b>34.0x56.0</b> |
| <b>FW02801<sup>a d</sup></b>  | Windshield (Solar) (Aftermarket, Rain Sensor) (To 083000) (06) .....                   | <b>34.0x56.0</b> |
| <b>FW02788<sup>a d</sup></b>  | Windshield (Solar) (Aftermarket) .....   | <b>34.0x56.0</b> |
| <b>FW02691<sup>b d</sup></b>  | Windshield (Solar) (PAAS System, Acoustic Interlayer, Rain Sensor) (From 083001) ..... | <b>34.0x56.0</b> |
| <b>FW02575<sup>b d</sup></b>  | Windshield (Solar) (PAAS System, Rain Sensor) (To 083000) (06) .....                   | <b>34.0x56.0</b> |
| <b>FW02301<sup>b d</sup></b>  | Windshield (Solar) (PAAS System) .....   | <b>34.0x56.0</b> |
| <b>FD21631-32</b>             | Door F/R-L (Solar) .....   | <b>19.0x36.0</b> |
| <b>FD21633-34</b>             | Door R/R-L (Solar) .....   | <b>19.0x28.0</b> |
| <b>FQ22815-16<sup>e</sup></b> | Quarter R-L (Encap)(Solar) .....   | <b>14.0x16.0</b> |
| <b>FB22817<sup>c</sup></b>    | Back Window (Ant)(Heated)(Solar) (PAAS System) .....                                   | <b>33.0x48.0</b> |

<sup>a</sup> Not On Production Vehicles  
<sup>b</sup> On Production Vehicles  
<sup>c</sup> High Modulus Urethane,Dam,Primer - 1.5 Tubes  
<sup>d</sup> High Modulus Urethane,Dam,Primer - 2 Tubes  
<sup>e</sup> High Modulus Urethane,Dam,Primer - 1 Tube

**A4 4 Door Station Wagon**..... **2009-2011**  
**S4 4 Door Station Wagon**..... **2009**

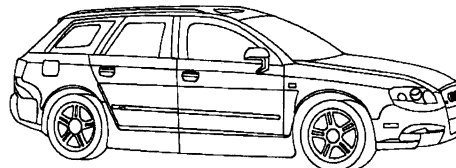

|                               |  |                  |
|-------------------------------|--|------------------|
| <b>FW02948<sup>b</sup></b>    | Windshield (Solar) (PAAS System, W/Lane Departure Warning System, Rain Sensor) (09-11) ..... | <b>36.0x57.5</b> |
| <b>FW02947<sup>b</sup></b>    | Windshield (Solar) (PAAS System, Rain Sensor) (09-11) .....                                  | <b>36.0x57.5</b> |
| <b>FW02946<sup>b</sup></b>    | Windshield (Solar) (PAAS System) (09-11) .....   | <b>36.0x57.5</b> |
| <b>FD23878-79</b>             | Door F/R-L (2 Holes)(Solar) (09-11) .....  | <b>18.5x29.0</b> |
| <b>FD23887-88</b>             | Door R/R-L (2 Holes)(Solar) (09-11) .....  | <b>17.0x28.0</b> |
| <b>FQ23889-90<sup>c</sup></b> | Quarter R-L (Ant)(Encap)(Solar) (Chrome Moulding) (09-11) .....                              | <b>15.0x32.0</b> |
| <b>FB23891<sup>a</sup></b>    | Back Window (Ant)(Heated)(1 Holes)(Solar) (W/ Wiper) (09-11) .....                           | <b>22.5x49.5</b> |

<sup>a</sup> High Modulus Urethane,Dam,Primer - 1.5 Tubes  
<sup>b</sup> High Modulus Urethane,Dam,Primer - 2 Tubes

|   |                |
|---|----------------|
| <b>A4</b>                                   | <i>(cont.)</i> |
| * High Modulus Urethane,Dam,Primer - 1 Tube |                |

|                                      |                  |
|--------------------------------------|------------------|
| <b>A4</b> 4 Door Station Wagon ..... | <b>2006-2008</b> |
| <b>S4</b> 4 Door Station Wagon.....  | <b>2006-2008</b> |

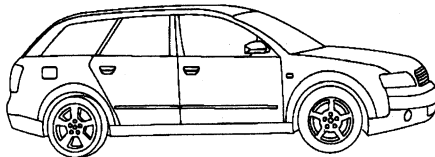

|   |                  |
|---|------------------|
| <b>FW02810<sup>a d</sup></b> Windshield (Solar) (Acoustic Interlayer, Aftermarket, Rain Sensor) (From 083001) ..... | <b>34.0x56.0</b> |
| <b>FW02801<sup>a d</sup></b> Windshield (Solar) (Aftermarket, Rain Sensor) (To 083000) (06) .....                   | <b>34.0x56.0</b> |
| <b>FW02788<sup>a d</sup></b> Windshield (Solar) (Aftermarket) .....   | <b>34.0x56.0</b> |
| <b>FW02691<sup>b d</sup></b> Windshield (Solar) (PAAS System, Acoustic Interlayer, Rain Sensor) (From 083001) ..... | <b>34.0x56.0</b> |
| <b>FW02575<sup>b d</sup></b> Windshield (Solar) (PAAS System, Rain Sensor) (To 083000) (06) .....                   | <b>34.0x56.0</b> |
| <b>FW02301<sup>b d</sup></b> Windshield (Solar) (PAAS System) .....   | <b>34.0x56.0</b> |
| <b>FD21631-32</b> Door F/R-L (Solar) .....  | <b>19.0x36.0</b> |
| <b>FD21640-41</b> Door R/R-L (Solar) .....  | <b>19.0x26.5</b> |
| <b>FQ22818-19<sup>e</sup></b> Quarter R-L (Encap)(Solar) .....  | <b>16.5x31.5</b> |
| <b>FB22820<sup>c</sup></b> Back Window (Ant)(Heated)(1 Holes)(Solar) (PAAS System) .....                            | <b>23.0x52.0</b> |

<sup>a</sup> Not On Production Vehicles  
<sup>b</sup> On Production Vehicles  
<sup>c</sup> High Modulus Urethane,Dam,Primer - 1.5 Tubes  
<sup>d</sup> High Modulus Urethane,Dam,Primer - 2 Tubes  
<sup>e</sup> High Modulus Urethane,Dam,Primer - 1 Tube

|                                    |                  |
|------------------------------------|------------------|
| <b>A5</b> 2 Door Convertible.....  | <b>2010-2011</b> |
| <b>S5</b> 2 Door Convertible ..... | <b>2010-2011</b> |

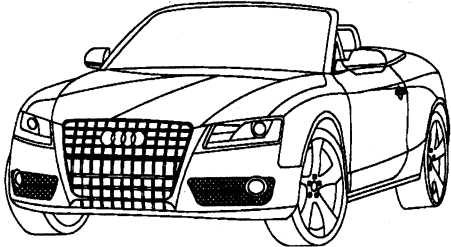

|  |                  |
|--|------------------|
| <b>FW03216<sup>a</sup></b> Windshield (Solar) (W/Lane Departure Warning System, Rain Sensor) ..... | <b>33.5x56.0</b> |
| <b>FW03195<sup>a</sup></b> Windshield (Solar) (Rain Sensor) .....                                  | <b>33.5x56.0</b> |
| <b>FW03194<sup>a</sup></b> Windshield (Solar) .....  | <b>33.5x56.0</b> |
| <b>FD24554-55</b> Door F/R-L (Solar) .....   | <b>17.0x37.0</b> |
| <b>FQ24556-57</b> Quarter R-L (Encap)(Solar) .....   | <b>17.0x22.5</b> |

<sup>a</sup> High Modulus Urethane,Dam,Primer - 2 Tubes

|                               |                  |
|-------------------------------|------------------|
| <b>A5</b> 2 Door Coupe.....   | <b>2008-2011</b> |
| <b>RS5</b> 2 Door Coupe ..... | <b>2009-2011</b> |
| <b>S5</b> 2 Door Coupe.....   | <b>2008-2011</b> |

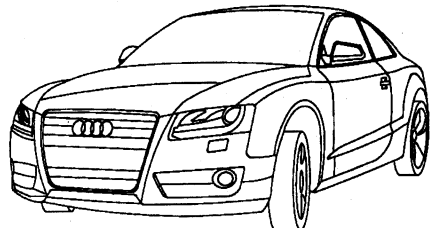

|  |                  |
|--|------------------|
| <b>FW02913<sup>b</sup></b> Windshield (Ant)(Solar) (PAAS System, W/Antenna Bracket, Rain Sensor) (08-11) ..... | <b>37.2x57.3</b> |
| <b>FW02912<sup>b</sup></b> Windshield (Solar) (PAAS System, Rain Sensor) (08-11) .....                         | <b>37.2x57.3</b> |
| <b>FW02911<sup>b</sup></b> Windshield (Solar) (PAAS System) (08-11) .....                                      | <b>37.2x57.3</b> |
| <b>FD23749-50</b> Door F/R-L (1 Holes)(Solar) (08-11) .....  | <b>20.5x38.9</b> |
| <b>FQ23751-52<sup>c</sup></b> Quarter R-L (Solar) (08-11) .....  | <b>14.6x29.7</b> |
| <b>FB23753<sup>a</sup></b> Back Window (Ant)(Heated)(Solar) (08-11) .....                                      | <b>32.0x47.7</b> |

<sup>a</sup> High Modulus Urethane,Dam,Primer - 1.5 Tubes  
<sup>b</sup> High Modulus Urethane,Dam,Primer - 2 Tubes  
<sup>c</sup> High Modulus Urethane,Dam,Primer - 1 Tube

|                              |                  |
|------------------------------|------------------|
| <b>A6</b> 4 Door Sedan ..... | <b>2006-2011</b> |
| <b>S6</b> 4 Door Sedan ..... | <b>2007-2011</b> |

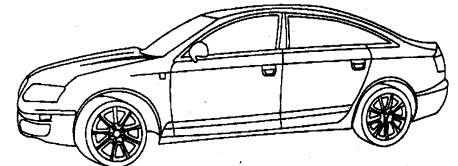

|   |                  |
|---|------------------|
| <b>FW02798<sup>a d</sup></b> Windshield (Solar) (VIN Notch, Aftermarket, Solar Coated, Rain Sensor) (06-11) ..... | <b>35.4x57.8</b> |
| <b>FW02797<sup>a d</sup></b> Windshield (Solar) (VIN Notch, Aftermarket, Rain Sensor) (06-11) .....               | <b>35.4x57.8</b> |
| <b>FW02545<sup>b d</sup></b> Windshield (Solar) (VIN Notch, PAAS System, Solar Coated, Rain Sensor) (06-11) ..... | <b>35.4x57.8</b> |
| <b>FW02530<sup>b d</sup></b> Windshield (Solar) (VIN Notch, PAAS System, Rain Sensor) (06-11) .....               | <b>35.4x57.8</b> |
| <b>FD22549-50</b> Door F/R-L (Solar) (06-11) .....  | <b>21.5x39.0</b> |
| <b>FD22551-52</b> Door R/R-L (Solar) (06-11) .....  | <b>20.0x29.8</b> |
| <b>FQ22553-54<sup>e</sup></b> Quarter R-L (Encap)(Solar) (06-11) .....  | <b>11.5x21.0</b> |
| <b>FB22555<sup>c</sup></b> Back Window (Ant)(Heated)(Solar) (PAAS System, W/Brake Light Bracket) (06-11) .....    | <b>31.5x47.5</b> |

<sup>a</sup> Not On Production Vehicles  
<sup>b</sup> On Production Vehicles  
<sup>c</sup> High Modulus Urethane,Dam,Primer - 1.5 Tubes  
<sup>d</sup> High Modulus Urethane,Dam,Primer - 2 Tubes  
<sup>e</sup> High Modulus Urethane,Dam,Primer - 1 Tube

|  |                  |
|--|------------------|
| <b>A6</b> 4 Door Station Wagon.....              | <b>2006-2011</b> |
| <b>Allroad Quattro</b> 4 Door Station Wagon..... | <b>2007-2009</b> |

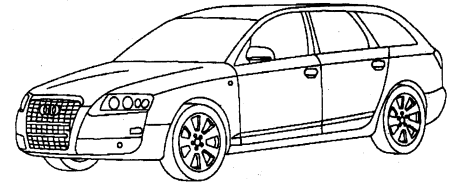

| <b>A6</b>               | <i>(cont.)</i>  |
|-------------------------|---|
| FW02798 <sup>a d</sup>  | Windshield (Solar) (VIN Notch, Aftermarket, Solar Coated, Rain Sensor) (06-11) ..... <b>35.4x57.8</b> |
| FW02797 <sup>a d</sup>  | Windshield (Solar) (VIN Notch, Aftermarket, Rain Sensor) (06-11) ..... <b>35.4x57.8</b>               |
| FW02545 <sup>b d</sup>  | Windshield (Solar) (VIN Notch, PAAS System, Solar Coated, Rain Sensor) (06-11) ..... <b>35.4x57.8</b> |
| FW02530 <sup>b d</sup>  | Windshield (Solar) (VIN Notch, PAAS System, Rain Sensor) (06-11) ..... <b>35.4x57.8</b>               |
| FD22549-50              | Door F/R-L (Solar) (06-11) ..... <b>21.5x39.0</b>   |
| FD22810-11              | Door R/R-L (2 Holes)(Solar) (06-11) ..... <b>20.8x30.3</b>  |
| FQ22812-13 <sup>c</sup> | Quarter R-L (Encap)(Solar) (06-11) ..... <b>15.0x32.0</b>   |
| FB22814 <sup>c</sup>    | Back Window (Ant)(Heated)(Solar) (06-11) ..... <b>22.3x49.0</b>                                       |

<sup>a</sup> Not On Production Vehicles  
<sup>b</sup> On Production Vehicles  
<sup>c</sup> High Modulus Urethane,Dam,Primer - 1.5 Tubes  
<sup>d</sup> High Modulus Urethane,Dam,Primer - 2 Tubes  
<sup>e</sup> High Modulus Urethane,Dam,Primer - 1 Tube

|                              |                  |
|------------------------------|------------------|
| <b>A8</b> 4 Door Sedan ..... | <b>2006-2010</b> |
| <b>S8</b> 4 Door Sedan.....  | <b>2007-2009</b> |

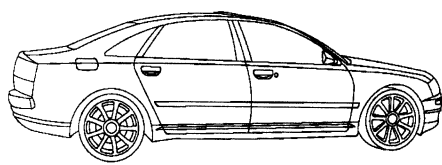

|                          |  |
|--------------------------|--|
| FW03324 <sup>a d</sup>   | Windshield (Solar) (W/Lane Departure Warning System, Aftermarket, Rain Sensor) (08-10) ..... <b>34.5x59.0</b>                      |
| FW03085 <sup>b d</sup>   | Windshield (Solar) (PAAS System, Acoustic Interlayer, W/Lane Departure Warning System, Rain Sensor) (08-10) ..... <b>34.5x59.0</b> |
| FW02806 <sup>a d</sup>   | Windshield (Solar) (Aftermarket, Rain Sensor) (06-10) ..... <b>34.5x59.0</b>   |
| FW02633 <sup>b c d</sup> | Windshield (Solar) (PAAS System, Acoustic Interlayer, Rain Sensor) (06-10) ..... <b>34.5x59.0</b>                                  |
| FD22236-37               | Door F/R-L (Solar) (Laminated) (06-10) ..... <b>20.0x35.0</b>  |
| FD22001-02               | Door F/R-L (Solar) (06-10) ..... <b>20.0x35.0</b>  |
| FD23965-66               | Door R/R-L (Solar) (Laminated) (06-10) ..... <b>20.0x35.0</b>  |
| FD23963-64               | Door R/R-L (Solar) (06-10) ..... <b>20.0x35.0</b>  |
| FV22240-41 <sup>e</sup>  | Vent R/R-L (Encap)(Solar) (Laminated) (06-10) ..... <b>10.5x19.5</b>   |
| FV22005-06 <sup>e</sup>  | Vent R/R-L (Encap)(Solar) (06-10) ..... <b>10.5x19.5</b>   |
| FB22007 <sup>d</sup>     | Back Window (Ant)(Heated)(Solar) (06-10) ..... <b>31.0x51.5</b>  |

<sup>a</sup> Not On Production Vehicles  
<sup>b</sup> On Production Vehicles  
<sup>c</sup> Mirror Button change from FW02399  
<sup>d</sup> High Modulus Non-Conductive Urethane,Dam,Primer - 2 Tubes  
<sup>e</sup> High Modulus Non-Conductive Urethane,Dam,Primer - 1 Tube

|                               |                  |
|-------------------------------|------------------|
| <b>A8L</b> 4 Door Sedan ..... | <b>2006-2010</b> |
|-------------------------------|------------------|

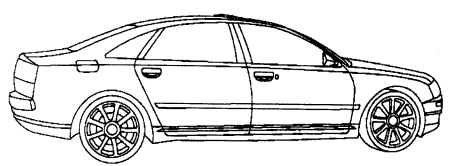

|                          |  |
|--------------------------|--|
| FW03324 <sup>a d</sup>   | Windshield (Solar) (W/Lane Departure Warning System, Aftermarket, Rain Sensor) (08-10) ..... <b>34.5x59.0</b>                      |
| FW03085 <sup>b d</sup>   | Windshield (Solar) (PAAS System, Acoustic Interlayer, W/Lane Departure Warning System, Rain Sensor) (08-10) ..... <b>34.5x59.0</b> |
| FW02806 <sup>a d</sup>   | Windshield (Solar) (Aftermarket, Rain Sensor) ..... <b>34.5x59.0</b>   |
| FW02633 <sup>b c d</sup> | Windshield (Solar) (PAAS System, Acoustic Interlayer, Rain Sensor) ..... <b>34.5x59.0</b>  |
| FD22236-37               | Door F/R-L (Solar) (Laminated) ..... <b>20.0x35.0</b>  |

| <b>A8L</b>              | <i>(cont.)</i>   |
|-------------------------|--|
| FD22001-02              | Door F/R-L (Solar) ..... <b>20.0x35.0</b>                    |
| FD22238-39              | Door R/R-L (Solar) (Laminated) ..... <b>20.0x34.5</b>        |
| FD22003-04              | Door R/R-L (Solar) ..... <b>20.0x34.5</b>                    |
| FV22240-41 <sup>e</sup> | Vent R/R-L (Encap)(Solar) (Laminated) ..... <b>10.5x19.5</b> |
| FV22005-06 <sup>e</sup> | Vent R/R-L (Encap)(Solar) ..... <b>10.5x19.5</b>             |
| FB22007 <sup>d</sup>    | Back Window (Ant)(Heated)(Solar) ..... <b>31.0x51.5</b>      |

<sup>a</sup> Not On Production Vehicles  
<sup>b</sup> On Production Vehicles  
<sup>c</sup> Mirror Button change from FW02399  
<sup>d</sup> High Modulus Non-Conductive Urethane,Dam,Primer - 2 Tubes  
<sup>e</sup> High Modulus Non-Conductive Urethane,Dam,Primer - 1 Tube

|                                |                  |
|--------------------------------|------------------|
| <b>Q5</b> 4 Door Utility ..... | <b>2009-2011</b> |
|--------------------------------|------------------|

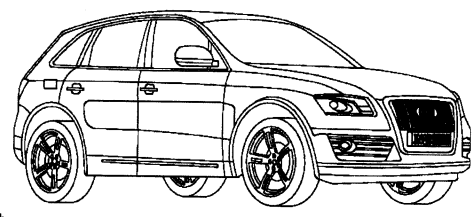

|                         |  |
|-------------------------|--|
| FW03099 <sup>b</sup>    | Windshield (Solar) (W/Lane Departure Warning System, Rain Sensor) ..... <b>38.0x50.0</b> |
| FW03098 <sup>b</sup>    | Windshield (Solar) (Rain Sensor) ..... <b>38.0x50.0</b>                                  |
| FW03097 <sup>b</sup>    | Windshield (Solar) ..... <b>38.0x50.0</b>  |
| FD24284-85              | Door F/R-L (Solar) ..... <b>21.0x31.0</b>  |
| FD24286-87              | Door R/R-L (2 Holes)(Solar) ..... <b>21.0x27.0</b>                                       |
| FQ24320 <sup>c</sup>    | Quarter L (Ant)(Encap)(Solar) ..... <b>16.0x20.0</b>                                     |
| FQ24288-89 <sup>c</sup> | Quarter R-L (Encap)(Solar) ..... <b>16.0x20.0</b>  |
| FB24290 <sup>a</sup>    | Back Window (Ant)(Heated)(1 Holes)(Solar) ..... <b>19.0x53.0</b>                         |

<sup>a</sup> High Modulus Urethane,Dam,Primer - 1.5 Tubes  
<sup>b</sup> High Modulus Urethane,Dam,Primer - 2 Tubes  
<sup>c</sup> High Modulus Urethane,Dam,Primer - 1 Tube

|                                |                  |
|--------------------------------|------------------|
| <b>Q7</b> 4 Door Utility ..... | <b>2007-2011</b> |
|--------------------------------|------------------|

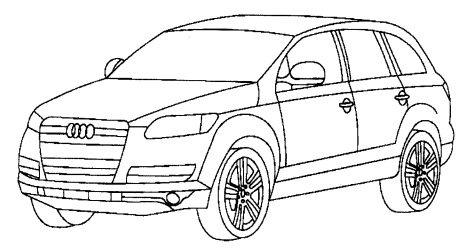

|                         |   |
|-------------------------|---|
| FW03339 <sup>b</sup>    | Windshield (Solar) (Acoustic Interlayer, W/Lane Departure Warning System, Rain/Light Sensor) (11) .... <b>40.5x58.5</b> |
| FW03338 <sup>b</sup>    | Windshield (Solar) (Acoustic Interlayer, Rain/Light Sensor) (11) ..... <b>40.5x58.5</b>                                 |
| FW02887 <sup>b</sup>    | Windshield (Solar) (W/Lane Departure Warning System, Rain/Light Sensor) (08-10) ..... <b>40.5x58.5</b>                  |
| FW02637 <sup>b</sup>    | Windshield (Solar) (Rain/Light Sensor) (07-10) ..... <b>40.5x58.5</b>   |
| FD22993-94              | Door F/R-L (Solar) (Laminated) ..... <b>20.0x35.0</b>   |
| FD22991-92              | Door F/R-L (2 Holes)(Solar) ..... <b>20.0x35.0</b>  |
| FD22997-98              | Door R/R-L (Solar) (Laminated) ..... <b>19.0x33.0</b>   |
| FD22995-96              | Door R/R-L (2 Holes)(Solar) ..... <b>19.0x33.0</b>  |
| FQ23001-02 <sup>c</sup> | Quarter R-L (Ant)(Encap)(Solar) (Laminated, Chrome Frame) ..... <b>15.5x25.0</b>  |
| FQ22999-00 <sup>c</sup> | Quarter R-L (Ant)(Encap)(Solar) (Chrome Frame) ..... <b>15.5x25.0</b>   |
| FB23003 <sup>a</sup>    | Back Window (Ant)(Heated)(1 Holes)(Solar) (PAAS System, W/Wiper) ..... <b>23.3x54.5</b>                                 |

<sup>a</sup> High Modulus Urethane,Dam,Primer - 1.5 Tubes  
<sup>b</sup> High Modulus Urethane,Dam,Primer - 2 Tubes  
<sup>c</sup> High Modulus Urethane,Dam,Primer - 1 Tube

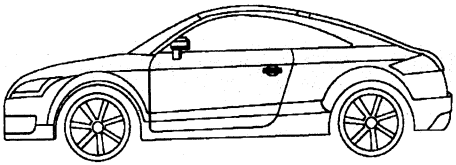
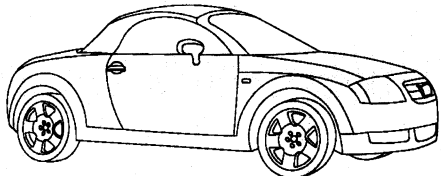
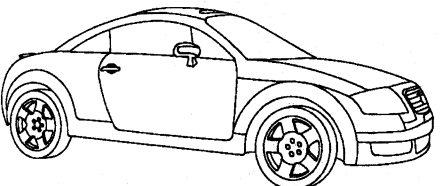
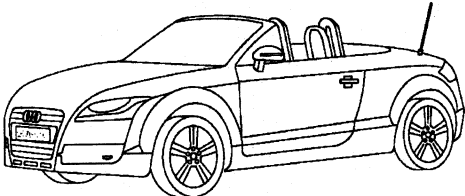
|   |   |
|---|---|
| <p><b>TT Coupe 2 Door Coupe ..... 2007-2011</b></p>  <p><b>FW02896<sup>b</sup></b> Windshield (Solar) ..... <b>34.0x58.0</b><br/> <b>FW02725<sup>b</sup></b> Windshield (Solar) (Rain Sensor) ..... <b>34.0x58.0</b><br/> <b>FD23344-45</b> Door F/R-L (1 Holes)(Solar) ..... <b>14.0x41.0</b><br/> <b>FQ23346-47<sup>c</sup></b> Quarter R-L (Encap)(Solar) ..... <b>9.0x23.0</b><br/> <b>FB23348<sup>a</sup></b> Back Window (Ant)(Heated)(Solar) (PAAS System) .. <b>37.0x41.0</b></p> <p><sup>a</sup> High Modulus Urethane,Dam,Primer - 1.5 Tubes<br/> <sup>b</sup> High Modulus Urethane,Dam,Primer - 2 Tubes<br/> <sup>c</sup> High Modulus Urethane,Dam,Primer - 1 Tube</p>  | <p><b>TT Roadster 2 Door Convertible..... 2006</b></p>  <p><b>FW02219<sup>a</sup></b> Windshield (Solar) ..... <b>30.5x58.5</b><br/> <b>FD21158-59</b> Door F/R-L (Solar) ..... <b>16.0x32.0</b><br/> <b>FV21156-57</b> Vent F/R-L (Solar) ..... <b>7.5x12.5</b><br/> <b>FB22314</b> Back Window (Heated)(Solar) (Glass Only, Aftermarket) ..... <b>12.3x40.0</b></p> <p><sup>a</sup> High Modulus Urethane,Dam,Primer - 2 Tubes</p>  |
| <p><b>TT Coupe 2 Door Coupe ..... 2006</b></p>  <p><b>FW02784<sup>a d</sup></b> Windshield (Solar) (Aftermarket) ..... <b>30.5x58.5</b><br/> <b>FW02240<sup>b d</sup></b> Windshield (Solar) (PAAS System) ..... <b>30.5x58.5</b><br/> <b>FD20786-87</b> Door F/R-L (2 Holes)(Solar) ..... <b>19.0x35.0</b><br/> <b>FQ20788-89<sup>e</sup></b> Quarter R-L (Encap)(Solar) ..... <b>8.5x18.0</b><br/> <b>FV20785<sup>c</sup></b> Vent F/L (Solar) ..... <b>12.1x17.2</b><br/> <b>FV20784<sup>a e</sup></b> Vent F/R (Solar) ..... <b>12.1x17.2</b><br/> <b>FB20790<sup>c</sup></b> Back Window (Ant)(Heated)(Solar) (PAAS System) .. <b>32.4x40.0</b></p> <p><sup>a</sup> Not On Production Vehicles<br/> <sup>b</sup> On Production Vehicles<br/> <sup>c</sup> High Modulus Urethane,Dam,Primer - 1.5 Tubes<br/> <sup>d</sup> High Modulus Urethane,Dam,Primer - 2 Tubes<br/> <sup>e</sup> High Modulus Urethane,Dam,Primer - 1 Tube</p> | <p><b>120 2 Door Hatchback (MEXICO Only) ..... 2008-2010</b><br/> <b>130 2 Door Hatchback (MEXICO Only) ..... 2008-2010</b></p> <p><b>FW02636<sup>a</sup></b> Windshield (Solar) (Solar Coated, Rain Sensor) ..... <b>33.0x57.0</b><br/> <b>FW02635<sup>a</sup></b> Windshield (Solar) (Rain Sensor, Condensation Sensor) ..... <b>33.0x57.0</b><br/> <b>FW02634<sup>a</sup></b> Windshield (Solar) (Condensation Sensor) ..... <b>33.0x57.0</b><br/> <b>FD23904-05</b> Door F/R-L (2 Holes)(Solar) ..... <b>21.9x41.3</b><br/> <b>FQ23910-11<sup>b</sup></b> Quarter R-L (Encap)(Solar) (Mexico Only, Chrome Frame) .....<br/> <b>FQ23908-09<sup>b</sup></b> Quarter R-L (Encap)(Solar) (Glossy Black Frame, Mexico Only) .....<br/> <b>FQ23906-07<sup>b</sup></b> Quarter R-L (Encap)(Solar) (Mexico Only, Flat Black Frame) .....<br/> <b>FB23913<sup>b</sup></b> Back Window (Ant)(Heated)(Solar) (Mexico Only, W/ Diversity Antenna, W/TV Antenna) .....<br/> <b>FB23912<sup>b</sup></b> Back Window (Ant)(Heated)(Solar) (Mexico Only, W/ Diversity Antenna) .....<br/> <b>FB22990<sup>b</sup></b> Back Window (Ant)(Heated)(Solar) (Mexico Only) ...</p> <p><sup>a</sup> Non-Conductive Urethane,Dam,Primer - 2 Tubes<br/> <sup>b</sup> Non-Conductive Urethane,Dam,Primer - 1.5 Tubes</p> <p><b>120 4 Door Hatchback (MEXICO Only) ..... 2006-2010</b><br/> <b>130 4 Door Hatchback (MEXICO Only) ..... 2006-2010</b></p> |
| <p><b>TT Roadster 2 Door Convertible..... 2008-2011</b></p>  <p><b>FW02898<sup>a</sup></b> Windshield (Solar) (Rain Sensor) ..... <b>34.0x58.0</b><br/> <b>FW02897<sup>a</sup></b> Windshield (Solar) ..... <b>34.0x58.0</b><br/> <b>FD23689-90</b> Door F/R-L (Solar) ..... <b>14.0x40.0</b></p> <p><sup>a</sup> High Modulus Urethane,Dam,Primer - 2 Tubes</p>   | <p><b>FW02636<sup>a</sup></b> Windshield (Solar) (Solar Coated, Rain Sensor) ..... <b>33.0x57.0</b><br/> <b>FW02635<sup>a</sup></b> Windshield (Solar) (Rain Sensor, Condensation Sensor) ..... <b>33.0x57.0</b><br/> <b>FW02634<sup>a</sup></b> Windshield (Solar) (Condensation Sensor) ..... <b>33.0x57.0</b><br/> <b>FD22984-85</b> Door F/R-L (Solar) .....<br/> <b>FD22986-87</b> Door R/R-L (Solar) (Mexico Only) .....<br/> <b>FV22988-89</b> Vent R/R-L (Solar) (Mexico Only) .....<br/> <b>FB23913<sup>b</sup></b> Back Window (Ant)(Heated)(Solar) (Mexico Only, W/ Diversity Antenna, W/TV Antenna) .....<br/> <b>FB23912<sup>b</sup></b> Back Window (Ant)(Heated)(Solar) (Mexico Only, W/ Diversity Antenna) .....<br/> <b>FB22990<sup>b</sup></b> Back Window (Ant)(Heated)(Solar) (Mexico Only) ...</p> <p><sup>a</sup> Non-Conductive Urethane,Dam,Primer - 2 Tubes<br/> <sup>b</sup> Non-Conductive Urethane,Dam,Primer - 1.5 Tubes</p>   |

**128** 2 Door Convertible..... **2008-2011**  
**135** 2 Door Convertible..... **2008-2011**

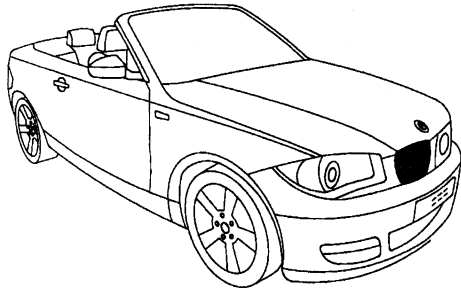

**FW02636<sup>a</sup>** Windshield (Solar) (Solar Coated, Rain Sensor) ..... **33.0x57.0**  
**FW02635<sup>a</sup>** Windshield (Solar) (Rain Sensor, Condensation Sensor) ..... **33.0x57.0**  
**FW02634<sup>a</sup>** Windshield (Solar) (Condensation Sensor) ..... **33.0x57.0**  
**FD24766-67** Door F/R-L (2 Holes)(Solar) ..... **22.8x40.7**  
**FQ23921-22** Quarter R-L (Solar) ..... **17.0x19.5**

<sup>a</sup> Non-Conductive Urethane,Dam,Primer - 2 Tubes

**128** 2 Door Coupe ..... **2008-2011**  
**135** 2 Door Coupe ..... **2008-2011**

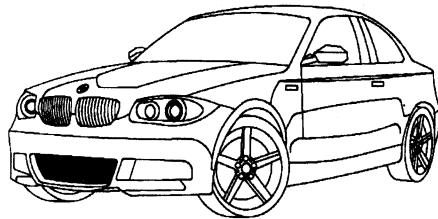

**FW02636<sup>a</sup>** Windshield (Solar) (Solar Coated, Rain Sensor) ..... **33.0x57.0**  
**FW02635<sup>a</sup>** Windshield (Solar) (Rain Sensor, Condensation Sensor) ..... **33.0x57.0**  
**FW02634<sup>a</sup>** Windshield (Solar) (Condensation Sensor) ..... **33.0x57.0**  
**FD23904-05** Door F/R-L (2 Holes)(Solar) ..... **21.9x41.3**  
**FQ23918-19<sup>c</sup>** Quarter R-L (Encap)(Solar) (Chrome Frame) ..... **15.0x29.0**  
**FQ23916-17<sup>c</sup>** Quarter R-L (Encap)(Solar) (Glossy Black Frame) ..... **15.0x29.0**  
**FQ23914-15<sup>c</sup>** Quarter R-L (Encap)(Solar) (Flat Black Frame) ..... **15.0x29.0**  
**FB23920<sup>b</sup>** Back Window (Ant)(Encap)(Heated)(Solar) ..... **25.0x48.5**

<sup>a</sup> Non-Conductive Urethane,Dam,Primer - 2 Tubes

<sup>b</sup> Non-Conductive Urethane,Dam,Primer - 1.5 Tubes

<sup>c</sup> Non-Conductive Urethane,Dam,Primer - 1 Tube

**323** 4 Door Sedan..... **2006-2011**  
 (CANADA Only)

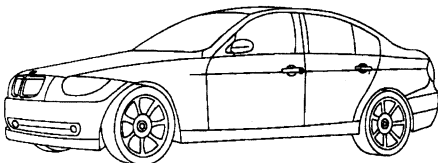

**FW02557<sup>a b</sup>** Windshield (Solar) (Solar Coated, Rain Sensor, Condensation Sensor) ..... **34.0x57.0**  
**FW02556<sup>a b</sup>** Windshield (Solar) (Rain Sensor, Condensation Sensor) ..... **34.0x57.0**  
**FW02555<sup>a b</sup>** Windshield (Solar) (Condensation Sensor) ..... **34.0x57.0**  
**FD22616-17** Door F/R-L (2 Holes) ..... **21.8x33.5**

**323** (cont.)

**FD22618-19** Door R/R-L (1 Holes) ..... **21.3x24.5**  
**FV22620-21<sup>d</sup>** Vent R/R-L (Solar) ..... **12.0x13.0**  
**FB22622<sup>c</sup>** Back Window (Ant)(Heated)(Solar) (W/Brake Light Bracket) ..... **28.0x49.0**

<sup>a</sup> Requires Replacement of Condensation Sensor

<sup>b</sup> Non-Conductive Urethane,Dam,Primer - 2 Tubes

<sup>c</sup> Non-Conductive Urethane,Dam,Primer - 1.5 Tubes

<sup>d</sup> Non-Conductive Urethane,Dam,Primer - 1 Tube

**325** 2 Door Convertible ..... **2006**  
**330** 2 Door Convertible ..... **2006**  
**M3** 2 Door Convertible..... **2006**

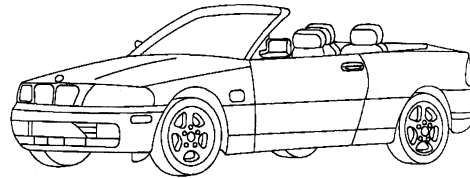

**FW02457<sup>a</sup>** Windshield (Solar) (W/Infrared, Rain Sensor) ..... **35.5x58.7**  
**FW02456<sup>a</sup>** Windshield (Rain Sensor) ..... **35.5x58.7**  
**FW02209<sup>a</sup>** Windshield (Solar) (W/Infrared) ..... **35.5x58.7**  
**FW02208<sup>a</sup>** Windshield ..... **35.5x58.7**  
**FD21022-23** Door F/R-L (Solar) ..... **19.0x41.0**  
**FQ21103-04** Quarter R-L (Solar) ..... **17.0x18.5**  
**FB21349** Back Window (Encap)(Heated)(Solar) (Glass Only, Aftermarket) ..... **15.0x39.0**

<sup>a</sup> Non-Conductive Urethane,Dam,Primer - 2 Tubes

**325** 2 Door Coupe ..... **2006**  
**330** 2 Door Coupe ..... **2006**  
**M3** 2 Door Coupe ..... **2006**

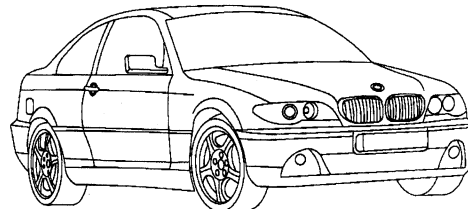

**FW02457<sup>a</sup>** Windshield (Solar) (W/Infrared, Rain Sensor) ..... **35.5x58.7**  
**FW02456<sup>a</sup>** Windshield (Rain Sensor) ..... **35.5x58.7**  
**FW02191<sup>a</sup>** Windshield (Solar) (W/Infrared) ..... **35.5x58.7**  
**FW02163<sup>a</sup>** Windshield ..... **35.5x58.7**  
**FD21022-23** Door F/R-L (Solar) ..... **19.0x41.0**  
**FQ21024-25** Quarter R-L (Encap)(1 Holes)(Solar) (Movable) ..... **15.8x30.4**  
**FB21027<sup>b</sup>** Back Window (Ant)(Heated)(Solar) ..... **29.0x51.0**  
**FB21026<sup>b</sup>** Back Window (Heated)(Solar) ..... **29.0x51.0**

<sup>a</sup> Non-Conductive Urethane,Dam,Primer - 2 Tubes

<sup>b</sup> Non-Conductive Urethane,Dam,Primer - 1.5 Tubes



|                       |           |
|-----------------------|-----------|
| 325 4 Door Sedan..... | 2006      |
| 328 4 Door Sedan..... | 2007-2011 |
| 330 4 Door Sedan..... | 2006      |
| 335 4 Door Sedan..... | 2007-2011 |
| M3 4 Door Sedan.....  | 2008-2011 |

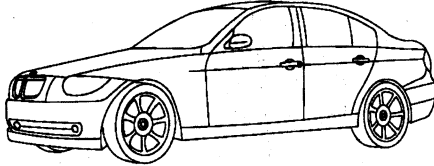

|  |           |
|--|-----------|
| FW02557 <sup>a b</sup> Windshield (Solar) (Solar Coated, Rain Sensor, Condensation Sensor) (06-11) ..... | 34.0x57.0 |
| FW02556 <sup>a b</sup> Windshield (Solar) (Rain Sensor, Condensation Sensor) (06-11) .....               | 34.0x57.0 |
| FW02555 <sup>a b</sup> Windshield (Solar) (Condensation Sensor) (06-11) .....                            | 34.0x57.0 |
| FD22616-17 Door F/R-L (2 Holes) (06-11) .....  | 21.8x33.5 |
| FD22618-19 Door R/R-L (1 Holes) (06-11) .....  | 21.3x24.5 |
| FV22620-21 <sup>d</sup> Vent R/R-L (Solar) (06-11) .....   | 12.0x13.0 |
| FB22622 <sup>c</sup> Back Window (Ant)(Heated)(Solar) (W/Brake Light Bracket) (06-11) .....              | 28.0x49.0 |

<sup>a</sup> Requires Replacement of Condensation Sensor  
<sup>b</sup> Non-Conductive Urethane,Dam,Primer - 2 Tubes  
<sup>c</sup> Non-Conductive Urethane,Dam,Primer - 1.5 Tubes  
<sup>d</sup> Non-Conductive Urethane,Dam,Primer - 1 Tube

|                               |           |
|-------------------------------|-----------|
| 325 4 Door Station Wagon..... | 2006      |
| 328 4 Door Station Wagon..... | 2007-2011 |

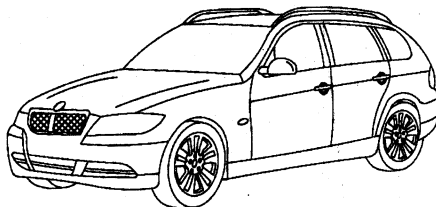

|  |           |
|--|-----------|
| FW02557 <sup>a b</sup> Windshield (Solar) (Solar Coated, Rain Sensor, Condensation Sensor) (06-11) ..... | 34.0x57.0 |
| FW02556 <sup>a b</sup> Windshield (Solar) (Rain Sensor, Condensation Sensor) (06-11) .....               | 34.0x57.0 |
| FW02555 <sup>a b</sup> Windshield (Solar) (Condensation Sensor) (06-11) .....                            | 34.0x57.0 |
| FD22616-17 Door F/R-L (2 Holes) (06-11) .....  | 21.8x33.5 |
| FD22623-24 Door R/R-L (Solar) (06-11) .....  | 21.0x24.0 |
| FQ22899 <sup>d</sup> Quarter L (Ant)(Encap)(Solar) (Glossy Black Frame) (06-11) .....                    | 14.0x24.0 |
| FQ22897 <sup>d</sup> Quarter L (Ant)(Encap)(Solar) (Chrome Frame) (06-11) .....                          | 14.0x24.0 |
| FQ22628 <sup>d</sup> Quarter L (Ant)(Encap)(Solar) (Flat Black Frame) (06-11) .....                      | 14.0x24.0 |
| FQ22898 <sup>d</sup> Quarter R (Encap)(Solar) (Glossy Black Frame) (06-11) .....                         | 14.0x24.0 |
| FQ22896 <sup>d</sup> Quarter R (Encap)(Solar) (Chrome Frame) (06-11) .....                               | 14.0x24.0 |
| FQ22627 <sup>d</sup> Quarter R (Encap)(Solar) (Flat Black Frame) (06-11) .....                           | 14.0x24.0 |
| FV22625-26 <sup>d</sup> Vent R/R-L (Solar) (06-11) .....   | 10.5x15.5 |
| FB22629 <sup>c</sup> Back Window (Heated)(Solar) (W/Brake Light Bracket) (06-11) .....                   | 19.0x49.0 |

<sup>a</sup> Requires Replacement of Condensation Sensor  
<sup>b</sup> Non-Conductive Urethane,Dam,Primer - 2 Tubes  
<sup>c</sup> Non-Conductive Urethane,Dam,Primer - 1.5 Tubes  
<sup>d</sup> Non-Conductive Urethane,Dam,Primer - 1 Tube

|                             |           |
|-----------------------------|-----------|
| 328 2 Door Convertible..... | 2007-2011 |
| 335 2 Door Convertible..... | 2007-2011 |
| M3 2 Door Convertible.....  | 2008-2011 |

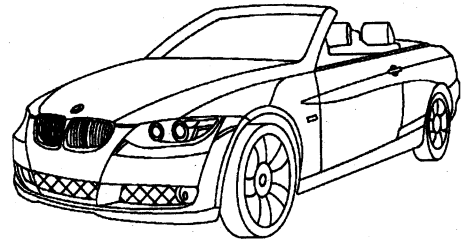

|   |           |
|---|-----------|
| FW02838 <sup>a b</sup> Windshield (Solar) (Solar Coated, Rain Sensor) (07-11) ..... | 32.0x55.0 |
| FW02837 <sup>a b</sup> Windshield (Solar) (Rain Sensor) (07-11) .....               | 32.0x55.0 |
| FW02836 <sup>b</sup> Windshield (Solar) (07-11) .....                               | 32.0x55.0 |
| FD23557-58 Door F/R-L (Solar) (07-11) .....   | 17.0x37.0 |
| FQ23559-60 Quarter R-L (Solar) (07-11) .....  | 17.0x30.5 |
| FB23561 <sup>c</sup> Back Window (Encap)(Heated)(Solar) (Hardtop) (07-11) .....     |           |

<sup>a</sup> Rain Sensor Kit  
<sup>b</sup> Non-Conductive Urethane,Dam,Primer - 2 Tubes  
<sup>c</sup> Non-Conductive Urethane,Dam,Primer - 1.5 Tubes

|                       |           |
|-----------------------|-----------|
| 328 2 Door Coupe..... | 2007-2011 |
| 335 2 Door Coupe..... | 2007-2011 |
| M3 2 Door Coupe.....  | 2008-2011 |

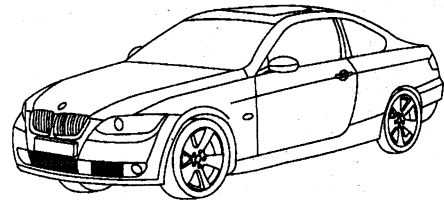

|   |           |
|---|-----------|
| FW02823 <sup>a b</sup> Windshield (Solar) (Solar Coated, Rain Sensor) (07-11) ..... | 33.0x55.0 |
| FW02738 <sup>a b</sup> Windshield (Solar) (Rain Sensor) (07-11) .....               | 33.0x55.0 |
| FW02737 <sup>a b</sup> Windshield (Solar) (07-11) .....                             | 33.0x55.0 |
| FD23410-11 Door F/R-L (Solar) (07-11) .....   | 21.8x43.3 |
| FQ23412-13 <sup>d</sup> Quarter R-L (Encap)(Solar) (07-11) .....                    | 15.5x28.0 |
| FB23414 <sup>c</sup> Back Window (Heated)(Solar) (07-11) .....                      | 29.0x48.5 |

<sup>a</sup> Requires Replacement of Condensation Sensor  
<sup>b</sup> Non-Conductive Urethane,Dam,Primer - 2 Tubes  
<sup>c</sup> Non-Conductive Urethane,Dam,Primer - 1.5 Tubes  
<sup>d</sup> Non-Conductive Urethane,Dam,Primer - 1 Tube

|                              |                  |
|------------------------------|------------------|
| <b>525</b> 4 Door Sedan..... | <b>2006-2007</b> |
| <b>528</b> 4 Door Sedan..... | <b>2008-2010</b> |
| <b>530</b> 4 Door Sedan..... | <b>2006-2007</b> |
| <b>535</b> 4 Door Sedan..... | <b>2008-2010</b> |
| <b>550</b> 4 Door Sedan..... | <b>2006-2010</b> |
| <b>M5</b> 4 Door Sedan.....  | <b>2006-2010</b> |

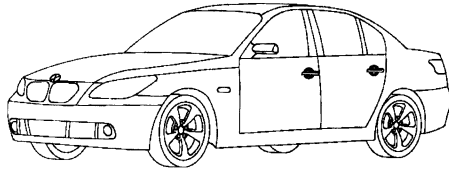

|   |                  |
|---|------------------|
| <b>FW02993<sup>a b</sup></b> Windshield (Solar) (W/Lane Departure Warning System, Solar Coated, Rain Sensor, Condensation Sensor) (08-10) ..... | <b>34.5x60.0</b> |
| <b>FW02992<sup>a b</sup></b> Windshield (Solar) (Solar Coated, Rain Sensor, Condensation Sensor) (08-10) .....                                  | <b>34.5x60.0</b> |
| <b>FW02991<sup>a b</sup></b> Windshield (HUD)(Solar) (W/Lane Departure Warning System, Rain Sensor, Condensation Sensor) (08-10) ....           | <b>34.5x60.0</b> |
| <b>FW02990<sup>a b</sup></b> Windshield (Solar) (W/Lane Departure Warning System, Rain Sensor, Condensation Sensor) (08-10) .....               | <b>34.5x60.0</b> |
| <b>FW02989<sup>a b</sup></b> Windshield (Solar) (Rain Sensor, Condensation Sensor) (08-10) .....  | <b>34.5x60.0</b> |
| <b>FW02675<sup>a b</sup></b> Windshield (HUD)(Solar) (Rain/Light Sensor, Condensation Sensor) (06-10) .....                                     | <b>34.5x60.0</b> |
| <b>FW02449<sup>a b</sup></b> Windshield (Solar) (Rain/Light Sensor, Solar Coated, Condensation Sensor) (06-07) .....                            | <b>34.5x60.0</b> |
| <b>FW02448<sup>a b</sup></b> Windshield (Solar) (Rain/Light Sensor, Condensation Sensor) (06-07) .....  | <b>34.5x60.0</b> |
| <b>FD22194-95</b> Door F/R-L (Solar) (Laminated, Solar Coated) (06-10)  | <b>20.0x29.5</b> |
| <b>FD22192-93</b> Door F/R-L (Solar) (Laminated) (06-10) .....  | <b>20.0x29.5</b> |
| <b>FD22190-91</b> Door F/R-L (Solar) (06-10) .....  | <b>20.0x29.5</b> |
| <b>FD22202-03</b> Door R/R-L (Solar) (Laminated, W/Sunshade) (06-10)  | <b>20.0x23.0</b> |
| <b>FD22200-01</b> Door R/R-L (Solar) (Laminated, Solar Coated) (06-10)  | <b>20.0x23.0</b> |
| <b>FD22198-99</b> Door R/R-L (Solar) (Laminated) (06-10) .....  | <b>20.0x23.0</b> |
| <b>FD22196-97</b> Door R/R-L (Solar) (06-10) .....  | <b>20.0x23.0</b> |
| <b>FV22210-11<sup>d</sup></b> Vent R/R-L (Solar) (Laminated, W/Sunshade) (06-10)  | <b>11.5x13.0</b> |
| <b>FV22208-09<sup>d</sup></b> Vent R/R-L (Solar) (Laminated, Solar Coated) (06-10)  | <b>11.5x13.0</b> |
| <b>FV22206-07<sup>d</sup></b> Vent R/R-L (Solar) (Laminated) (06-10) .....  | <b>11.5x13.0</b> |
| <b>FV22204-05<sup>d</sup></b> Vent R/R-L (Solar) (06-10) .....  | <b>11.5x13.0</b> |
| <b>FB22214<sup>c</sup></b> Back Window (Ant)(Heated)(Solar) (Laminated, Solar Coated, W/Sunshade) (06-10) .....                                 | <b>29.5x51.5</b> |
| <b>FB22213<sup>c</sup></b> Back Window (Ant)(Heated)(Solar) (Laminated, Solar Coated) (06-10) .....   | <b>29.5x51.5</b> |
| <b>FB22212<sup>c</sup></b> Back Window (Ant)(Heated)(Solar) (06-10) .....   | <b>29.5x51.5</b> |

<sup>a</sup> Requires Replacement of Condensation Sensor  
<sup>b</sup> Non-Conductive Urethane,Dam,Primer - 2 Tubes  
<sup>c</sup> Non-Conductive Urethane,Dam,Primer - 1.5 Tubes  
<sup>d</sup> Non-Conductive Urethane,Dam,Primer - 1 Tube

|                              |             |
|------------------------------|-------------|
| <b>528</b> 4 Door Sedan..... | <b>2011</b> |
| <b>535</b> 4 Door Sedan..... | <b>2011</b> |
| <b>550</b> 4 Door Sedan..... | <b>2011</b> |

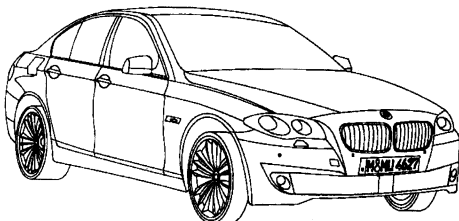

**528** (cont.)

|   |  |
|---|--|
| <b>FW03297<sup>a b</sup></b> Windshield (HUD)(Solar) (W/Lane Departure Warning System, Solar Coated, Rain Sensor) ..... |  |
| <b>FW03296<sup>a b</sup></b> Windshield (Solar) (W/Lane Departure Warning System, Solar Coated, Rain Sensor) .....      |  |
| <b>FW03295<sup>a b</sup></b> Windshield (HUD)(Solar) (Solar Coated, Rain Sensor) .....                                  |  |
| <b>FW03294<sup>a b</sup></b> Windshield (Solar) (Solar Coated, Rain Sensor) .....                                       |  |
| <b>FW03293<sup>a b</sup></b> Windshield (HUD)(Solar) (W/Lane Departure Warning System, Rain Sensor) .....               |  |
| <b>FW03292<sup>a b</sup></b> Windshield (Solar) (W/Lane Departure Warning System, Rain Sensor) .....                    |  |
| <b>FW03291<sup>a b</sup></b> Windshield (HUD)(Solar) (Rain Sensor) .....  |  |
| <b>FW03290<sup>a b</sup></b> Windshield (Solar) (Rain Sensor) .....   |  |
| <b>FD24759-60</b> Door F/R-L (Solar) .....  |  |
| <b>FD24761-62</b> Door R/R-L (Solar) .....  |  |
| <b>FV24763-64</b> Vent R/R-L (Encap)(Solar) .....   |  |
| <b>FB24765<sup>c</sup></b> Back Window (Ant)(Heated)(Solar) .....   |  |

<sup>a</sup> Rain Sensor Kit  
<sup>b</sup> Non-Conductive Urethane,Dam,Primer - 2 Tubes  
<sup>c</sup> Non-Conductive Urethane,Dam,Primer - 1.5 Tubes

|                                      |                  |
|--------------------------------------|------------------|
| <b>530</b> 4 Door Station Wagon..... | <b>2006-2007</b> |
| <b>535</b> 4 Door Station Wagon..... | <b>2008-2010</b> |

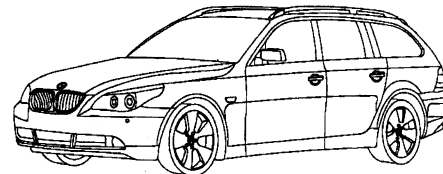

|   |                  |
|---|------------------|
| <b>FW02993<sup>a b</sup></b> Windshield (Solar) (W/Lane Departure Warning System, Solar Coated, Rain Sensor, Condensation Sensor) (08-10) ..... | <b>34.5x60.0</b> |
| <b>FW02992<sup>a b</sup></b> Windshield (Solar) (Solar Coated, Rain Sensor, Condensation Sensor) (08-10) .....                                  | <b>34.5x60.0</b> |
| <b>FW02991<sup>a b</sup></b> Windshield (HUD)(Solar) (W/Lane Departure Warning System, Rain Sensor, Condensation Sensor) (08-10) ....           | <b>34.5x60.0</b> |
| <b>FW02990<sup>a b</sup></b> Windshield (Solar) (W/Lane Departure Warning System, Rain Sensor, Condensation Sensor) (08-10) .....               | <b>34.5x60.0</b> |
| <b>FW02989<sup>a b</sup></b> Windshield (Solar) (Rain Sensor, Condensation Sensor) (08-10) .....  | <b>34.5x60.0</b> |
| <b>FW02675<sup>a b</sup></b> Windshield (HUD)(Solar) (Rain/Light Sensor, Condensation Sensor) (06-10) .....                                     | <b>34.5x60.0</b> |
| <b>FW02449<sup>a b</sup></b> Windshield (Solar) (Rain/Light Sensor, Solar Coated, Condensation Sensor) (06-07) .....                            | <b>34.5x60.0</b> |
| <b>FW02448<sup>a b</sup></b> Windshield (Solar) (Rain/Light Sensor, Condensation Sensor) (06-07) .....  | <b>34.5x60.0</b> |
| <b>FD22194-95</b> Door F/R-L (Solar) (Laminated, Solar Coated) (06-10)  | <b>20.0x29.5</b> |
| <b>FD22192-93</b> Door F/R-L (Solar) (Laminated) (06-10) .....  | <b>20.0x29.5</b> |
| <b>FD22190-91</b> Door F/R-L (Solar) (06-10) .....  | <b>20.0x29.5</b> |
| <b>FD22789-90</b> Door R/R-L (Solar) (Laminated, Solar Coated, W/Sunshade) (06-10) .....  | <b>17.0x22.5</b> |
| <b>FD22787-88</b> Door R/R-L (Solar) (Laminated, Solar Coated) (06-10)  | <b>17.0x22.5</b> |
| <b>FD22785-86</b> Door R/R-L (Solar) (Laminated) (06-10) .....  | <b>17.0x22.5</b> |
| <b>FD22783-84</b> Door R/R-L (Solar) (06-10) .....  | <b>17.0x22.5</b> |
| <b>FQ22805-06<sup>d</sup></b> Quarter R-L (Encap)(Solar) (Laminated, Solar Coated, W/Sunshade) (06-10) .....                                    | <b>15.0x28.0</b> |
| <b>FQ22803-04<sup>d</sup></b> Quarter R-L (Encap)(Solar) (Laminated, Solar Coated) (06-10) .....  | <b>15.0x28.0</b> |
| <b>FQ22801-02<sup>d</sup></b> Quarter R-L (Encap)(Solar) (Laminated) (06-10) .....  | <b>15.0x28.0</b> |
| <b>FQ22799-00<sup>d</sup></b> Quarter R-L (Encap)(Solar) (06-10) .....  | <b>15.0x28.0</b> |
| <b>FV22797-98<sup>d</sup></b> Vent R/R-L (Solar) (Laminated, Solar Coated, W/Sunshade) (06-10) .....  | <b>10.0x15.0</b> |
| <b>FV22795-96<sup>d</sup></b> Vent R/R-L (Solar) (Laminated, Solar Coated) (06-10)  | <b>10.0x15.0</b> |
| <b>FV22793-94<sup>d</sup></b> Vent R/R-L (Solar) (Laminated) (06-10) .....  | <b>10.0x15.0</b> |
| <b>FV22791-92<sup>d</sup></b> Vent R/R-L (Solar) (06-10) .....  | <b>10.0x15.0</b> |

**530 (cont.)**

|                            |   |                  |
|----------------------------|---|------------------|
| <b>FB22809<sup>c</sup></b> | Back Window (Ant)(Encap)(Heated)(Solar) (Laminated, Solar Coated, W/Sunshade) (06-10) ..... | <b>20.0x54.0</b> |
| <b>FB22808<sup>c</sup></b> | Back Window (Ant)(Encap)(Heated)(Solar) (Laminated, Solar Coated) (06-10) .....             | <b>20.0x54.0</b> |
| <b>FB22807<sup>c</sup></b> | Back Window (Ant)(Encap)(Heated)(Solar) (06-10) ...   | <b>20.0x54.0</b> |

<sup>a</sup> Requires Replacement of Condensation Sensor  
<sup>b</sup> Non-Conductive Urethane,Dam,Primer - 2 Tubes  
<sup>c</sup> Non-Conductive Urethane,Dam,Primer - 1.5 Tubes  
<sup>d</sup> Non-Conductive Urethane,Dam,Primer - 1 Tube

**535 4 Door Station Wagon..... 2011**

|                               |  |  |
|-------------------------------|--|--|
| <b>FW03297<sup>a b</sup></b>  | Windshield (HUD)(Solar) (W/Lane Departure Warning System, Solar Coated, Rain Sensor) ..... |  |
| <b>FW03296<sup>a b</sup></b>  | Windshield (Solar) (W/Lane Departure Warning System, Solar Coated, Rain Sensor) .....      |  |
| <b>FW03295<sup>a b</sup></b>  | Windshield (HUD)(Solar) (Solar Coated, Rain Sensor) .....                                  |  |
| <b>FW03294<sup>a b</sup></b>  | Windshield (Solar) (Solar Coated, Rain Sensor) .....                                       |  |
| <b>FW03293<sup>a b</sup></b>  | Windshield (HUD)(Solar) (W/Lane Departure Warning System, Rain Sensor) .....               |  |
| <b>FW03292<sup>a b</sup></b>  | Windshield (Solar) (W/Lane Departure Warning System, Rain Sensor) .....                    |  |
| <b>FW03291<sup>a b</sup></b>  | Windshield (HUD)(Solar) (Rain Sensor) .....  |  |
| <b>FW03290<sup>a b</sup></b>  | Windshield (Solar) (Rain Sensor) .....   |  |
| <b>FD24759-60</b>             | Door F/R-L (Solar) .....   |  |
| <b>FD24773-74</b>             | Door R/R-L (Solar) .....   |  |
| <b>FQ24779-80<sup>c</sup></b> | Quarter R-L (Ant)(Solar) .....   |  |
| <b>FQ24777-78<sup>c</sup></b> | Quarter R-L (Solar) .....  |  |
| <b>FV24775-76</b>             | Vent R/R-L (Encap)(Solar) .....  |  |
| <b>FB24781<sup>c</sup></b>    | Back Window (Ant)(Heated)(Solar) .....   |  |

<sup>a</sup> Rain Sensor Kit  
<sup>b</sup> Non-Conductive Urethane,Dam,Primer - 2 Tubes  
<sup>c</sup> Non-Conductive Urethane,Dam,Primer - 1.5 Tubes

**535 GT 4 Door Sedan..... 2010-2011**  
**550 GT 4 Door Sedan..... 2010-2011**

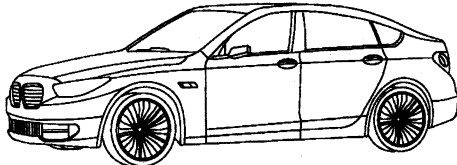

|                               |   |  |
|-------------------------------|---|--|
| <b>FW03245<sup>a</sup></b>    | Windshield (Solar) (W/Third Visor Frit, W/Lane Departure Warning System, Solar Coated, Rain Sensor) ..... |  |
| <b>FW03244<sup>a</sup></b>    | Windshield (Solar) (W/Third Visor Frit, Solar Coated, Rain Sensor) .....                                  |  |
| <b>FW03243<sup>a</sup></b>    | Windshield (Solar) (W/Third Visor Frit, W/Lane Departure Warning System, Rain Sensor) .....               |  |
| <b>FW03242<sup>a</sup></b>    | Windshield (Solar) (W/Third Visor Frit, Rain Sensor) .....  |  |
| <b>FD24689-90</b>             | Door F/R-L (Solar) .....  |  |
| <b>FD24691-92</b>             | Door R/R-L (Solar) .....  |  |
| <b>FQ24695-96<sup>b</sup></b> | Quarter R-L (Encap)(Solar) .....  |  |
| <b>FV24693-94<sup>b</sup></b> | Vent R/R-L (Encap)(Solar) .....   |  |
| <b>FB24697<sup>b</sup></b>    | Back Window (Ant)(Heated)(Solar) .....  |  |

<sup>a</sup> Non-Conductive Urethane,Dam,Primer - 2 Tubes  
<sup>b</sup> Non-Conductive Urethane,Dam,Primer - 1.5 Tubes

**650 2 Door Convertible..... 2006-2010**  
**M6 2 Door Convertible..... 2007-2010**

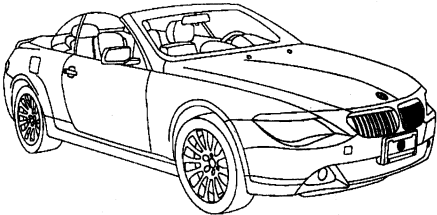

|                              |  |                  |
|------------------------------|--|------------------|
| <b>FW02770<sup>a b</sup></b> | Windshield (HUD)(Solar) (Solar Coated, Rain Sensor, Condensation Sensor) (06-10) ..... | <b>36.0x57.0</b> |
| <b>FW02769<sup>a b</sup></b> | Windshield (Solar) (Solar Coated, Rain Sensor, Condensation Sensor) (06-10) .....      | <b>36.0x57.0</b> |
| <b>FW02492<sup>a b</sup></b> | Windshield (HUD)(Solar) (Rain Sensor, Condensation Sensor) (06-10) .....               | <b>36.0x57.0</b> |
| <b>FW02491<sup>a b</sup></b> | Windshield (Solar) (Rain Sensor, Condensation Sensor) (06-10) .....                    | <b>36.0x57.0</b> |
| <b>FD22374-75</b>            | Door F/R-L (Solar) (06-10) .....   | <b>17.0x39.0</b> |
| <b>FQ22379-80</b>            | Quarter R-L (Solar) (06-10) .....  |                  |
| <b>FB23487</b>               | Back Window (Heated)(Solar) (06-10) .....  |                  |

<sup>a</sup> Requires Replacement of Condensation Sensor  
<sup>b</sup> Non-Conductive Urethane,Dam,Primer - 2 Tubes

**650 2 Door Coupe..... 2006-2010**  
**M6 2 Door Coupe..... 2006-2010**

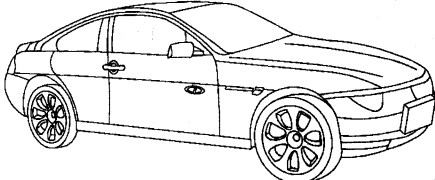

|                               |  |                  |
|-------------------------------|--|------------------|
| <b>FW02770<sup>a b</sup></b>  | Windshield (HUD)(Solar) (Solar Coated, Rain Sensor, Condensation Sensor) ..... | <b>36.0x57.0</b> |
| <b>FW02769<sup>a b</sup></b>  | Windshield (Solar) (Solar Coated, Rain Sensor, Condensation Sensor) .....      | <b>36.0x57.0</b> |
| <b>FW02492<sup>a b</sup></b>  | Windshield (HUD)(Solar) (Rain Sensor, Condensation Sensor) .....               | <b>36.0x57.0</b> |
| <b>FW02491<sup>a b</sup></b>  | Windshield (Solar) (Rain Sensor, Condensation Sensor) .....                    | <b>36.0x57.0</b> |
| <b>FD22374-75</b>             | Door F/R-L (Solar) .....   | <b>17.0x39.0</b> |
| <b>FQ22376-77<sup>d</sup></b> | Quarter R-L (Solar) .....  | <b>14.0x31.0</b> |
| <b>FB23939<sup>c</sup></b>    | Back Window (Ant)(Heated)(Solar) (Solar Coated) ...                            | <b>32.0x46.5</b> |
| <b>FB22378<sup>c</sup></b>    | Back Window (Ant)(Heated)(Solar) .....   | <b>32.0x46.5</b> |

<sup>a</sup> Requires Replacement of Condensation Sensor  
<sup>b</sup> Non-Conductive Urethane,Dam,Primer - 2 Tubes  
<sup>c</sup> Non-Conductive Urethane,Dam,Primer - 1.5 Tubes  
<sup>d</sup> Non-Conductive Urethane,Dam,Primer - 1 Tube

**740 4 Door Sedan..... 2011**  
**750 4 Door Sedan..... 2009-2011**  
**Alpina B7 4 Door Sedan..... 2011**

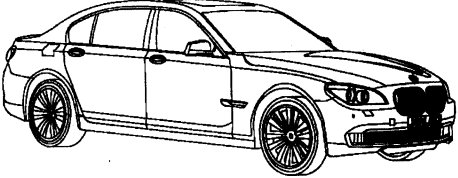

| 740                  | (cont.)   |           |
|----------------------|---|-----------|
| FW03130 <sup>a</sup> | Windshield (HUD)(Solar) (W/Lane Departure Warning System, Solar Coated, Rain Sensor, Condensation Sensor) (09-11) .....                 | 38.0x62.0 |
| FW03129 <sup>a</sup> | Windshield (HUD)(Solar) (Acoustic Interlayer, Solar Coated, Rain Sensor, Condensation Sensor) (09-11) .....                             | 38.0x62.0 |
| FW03128 <sup>a</sup> | Windshield (HUD)(Solar) (W/Lane Departure Warning System, Rain Sensor, Condensation Sensor) (09-11) .....                               | 38.0x62.0 |
| FW03127 <sup>a</sup> | Windshield (HUD)(Solar) (Rain Sensor, Condensation Sensor) (09-11) .....  | 38.0x62.0 |
| FW03065 <sup>a</sup> | Windshield (Solar) (Acoustic Interlayer, W/Lane Departure Warning System, Solar Coated, Rain Sensor, Condensation Sensor) (09-11) ..... | 38.0x62.0 |
| FW03064 <sup>a</sup> | Windshield (Solar) (Acoustic Interlayer, Solar Coated, Rain Sensor, Condensation Sensor) (09-11) .....                                  | 38.0x62.0 |
| FW03063 <sup>a</sup> | Windshield (Solar) (W/Lane Departure Warning System, Rain Sensor, Condensation Sensor) (09-11) .....                                    | 38.0x62.0 |
| FW03062 <sup>a</sup> | Windshield (Solar) (Rain Sensor, Condensation Sensor) (09-11) .....   | 38.0x62.0 |
| FD24184-85           | Door F/R-L (Solar) (Laminated) (09-11) .....  | 20.0x32.0 |
| FD24182-83           | Door F/R-L (2 Holes)(Solar) (09-11) .....   | 20.0x32.0 |
| FD24188-89           | Door R/R-L (Solar) (Laminated) (09-11) .....  |           |
| FD24186-87           | Door R/R-L (1 Holes)(Solar) (09-11) .....   |           |
| FV24192-93           | Vent R/R-L (Solar) (Laminated) (09-11) .....  |           |
| FV24190-91           | Vent R/R-L (Solar) (09-11) .....  |           |
| FB24195 <sup>b</sup> | Back Window (Ant)(Heated)(Solar) (Laminated, W/ Diversity Antenna) (09-11) .....  | 31.0x48.0 |
| FB24194 <sup>b</sup> | Back Window (Ant)(Heated)(Solar) (W/Diversity Antenna) (09-11) .....  | 31.0x48.0 |

<sup>a</sup> Non-Conductive Urethane,Dam,Primer - 2 Tubes  
<sup>b</sup> Non-Conductive Urethane,Dam,Primer - 1.5 Tubes

|                           |           |
|---------------------------|-----------|
| 740 LI 4 Door Sedan ..... | 2011      |
| 750 LI 4 Door Sedan ..... | 2009-2011 |
| 760 LI 4 Door Sedan ..... | 2010-2011 |



|                      |   |           |
|----------------------|---|-----------|
| FW03130 <sup>a</sup> | Windshield (HUD)(Solar) (W/Lane Departure Warning System, Solar Coated, Rain Sensor, Condensation Sensor) (09-11) .....                 | 38.0x62.0 |
| FW03129 <sup>a</sup> | Windshield (HUD)(Solar) (Acoustic Interlayer, Solar Coated, Rain Sensor, Condensation Sensor) (09-11) .....                             | 38.0x62.0 |
| FW03128 <sup>a</sup> | Windshield (HUD)(Solar) (W/Lane Departure Warning System, Rain Sensor, Condensation Sensor) (09-11) .....                               | 38.0x62.0 |
| FW03127 <sup>a</sup> | Windshield (HUD)(Solar) (Rain Sensor, Condensation Sensor) (09-11) .....  | 38.0x62.0 |
| FW03065 <sup>a</sup> | Windshield (Solar) (Acoustic Interlayer, W/Lane Departure Warning System, Solar Coated, Rain Sensor, Condensation Sensor) (09-11) ..... | 38.0x62.0 |
| FW03064 <sup>a</sup> | Windshield (Solar) (Acoustic Interlayer, Solar Coated, Rain Sensor, Condensation Sensor) (09-11) .....                                  | 38.0x62.0 |
| FW03063 <sup>a</sup> | Windshield (Solar) (W/Lane Departure Warning System, Rain Sensor, Condensation Sensor) (09-11) .....                                    | 38.0x62.0 |
| FW03062 <sup>a</sup> | Windshield (Solar) (Rain Sensor, Condensation Sensor) (09-11) .....   | 38.0x62.0 |
| FD24184-85           | Door F/R-L (Solar) (Laminated) (09-11) .....  | 20.0x32.0 |
| FD24182-83           | Door F/R-L (2 Holes)(Solar) (09-11) .....   | 20.0x32.0 |
| FD24198-99           | Door R/R-L (Solar) (Laminated) (09-11) .....  | 20.0x31.0 |
| FD24196-97           | Door R/R-L (Solar) (09-11) .....  | 20.0x31.0 |
| FV24202-03           | Vent R/R-L (Solar) (Laminated) (09-11) .....  | 13.5x15.0 |
| FV24200-01           | Vent R/R-L (Solar) (09-11) .....  | 13.5x15.0 |
| FB24205 <sup>b</sup> | Back Window (Ant)(Heated)(Solar) (Laminated, W/ Diversity Antenna) (09-11) .....  | 31.0x48.0 |

| 740                  | (cont.)  |           |
|----------------------|--|-----------|
| FB24204 <sup>b</sup> | Back Window (Ant)(Heated)(Solar) (W/Diversity Antenna) (09-11) ..... | 31.0x48.0 |

<sup>a</sup> Non-Conductive Urethane,Dam,Primer - 2 Tubes  
<sup>b</sup> Non-Conductive Urethane,Dam,Primer - 1.5 Tubes

|                              |           |
|------------------------------|-----------|
| 750 4 Door Sedan .....       | 2006-2008 |
| 760 4 Door Sedan .....       | 2006      |
| Alpina B7 4 Door Sedan ..... | 2008      |

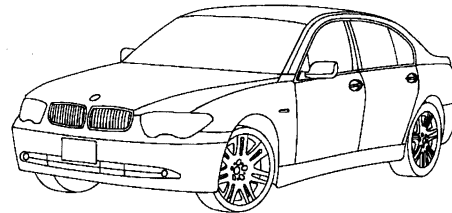

|                         |   |           |
|-------------------------|---|-----------|
| FW02544 <sup>a b</sup>  | Windshield (Heated)(Solar) (Heated Wiper Park Area, Rain Sensor, Condensation Sensor) (06-08) .....               | 38.5x65.5 |
| FW02483 <sup>a b</sup>  | Windshield (Heated)(Solar) (Heated Wiper Park Area, Solar Coated, Rain Sensor, Condensation Sensor) (06-08) ..... | 38.5x65.5 |
| FW02312 <sup>b</sup>    | Windshield (Heated)(Solar) (Heated Wiper Park Area) (06-08) .....   | 38.5x65.5 |
| FD21659-60              | Door F/R-L (Solar) (Laminated) (06-08) .....  | 20.0x30.0 |
| FD21657-58              | Door F/R-L (Solar) (06-08) .....  | 20.0x30.0 |
| FD21663-64              | Door R/R-L (Solar) (Laminated) (06-08) .....  | 20.0x28.5 |
| FD21661-62              | Door R/R-L (Solar) (06-08) .....  | 20.0x28.5 |
| FV21667-68 <sup>c</sup> | Vent R/R-L (Encap)(Solar) (Laminated) (06-08) .....   | 14.2x15.7 |
| FV21665-66 <sup>c</sup> | Vent R/R-L (Solar) (06-08) .....  | 14.2x15.7 |
| FB21670 <sup>b</sup>    | Back Window (Encap)(Heated)(Solar) (Laminated, Solar Coated) (06-08) .....  | 31.5x56.0 |
| FB21669 <sup>b</sup>    | Back Window (Encap)(Heated)(Solar) (06-08) .....  | 31.5x56.0 |

<sup>a</sup> Requires Replacement of Condensation Sensor  
<sup>b</sup> Non-Conductive Urethane,Dam,Primer - 2 Tubes  
<sup>c</sup> Non-Conductive Urethane,Dam,Primer - 1 Tube

|                           |           |
|---------------------------|-----------|
| 750 LI 4 Door Sedan ..... | 2006-2008 |
| 760 LI 4 Door Sedan ..... | 2006-2008 |

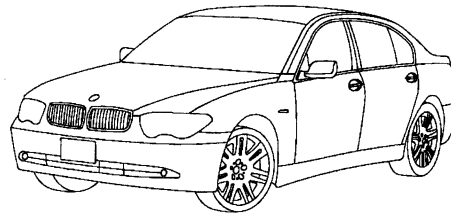

|                         |   |           |
|-------------------------|---|-----------|
| FW02544 <sup>a b</sup>  | Windshield (Heated)(Solar) (Heated Wiper Park Area, Rain Sensor, Condensation Sensor) .....               | 38.5x65.5 |
| FW02483 <sup>a b</sup>  | Windshield (Heated)(Solar) (Heated Wiper Park Area, Solar Coated, Rain Sensor, Condensation Sensor) ..... | 38.5x65.5 |
| FW02312 <sup>b</sup>    | Windshield (Heated)(Solar) (Heated Wiper Park Area) .....   | 38.5x65.5 |
| FD21659-60              | Door F/R-L (Solar) (Laminated) .....  | 20.0x30.0 |
| FD21657-58              | Door F/R-L (Solar) .....  | 20.0x30.0 |
| FD22234-35              | Door R/R-L (Solar) (Laminated) .....  | 27.5x28.5 |
| FD22232-33              | Door R/R-L (Solar) .....  | 27.5x28.5 |
| FV21667-68 <sup>c</sup> | Vent R/R-L (Encap)(Solar) (Laminated) .....   | 14.2x15.7 |
| FV21665-66 <sup>c</sup> | Vent R/R-L (Solar) .....  | 14.2x15.7 |
| FB21670 <sup>b</sup>    | Back Window (Encap)(Heated)(Solar) (Laminated, Solar Coated) .....  | 31.5x56.0 |

**750 (cont.)**

- FB21669<sup>b</sup>** Back Window (Encap)(Heated)(Solar) ..... 31.5x56.0
- <sup>a</sup> Requires Replacement of Condensation Sensor
- <sup>b</sup> Non-Conductive Urethane,Dam,Primer - 2 Tubes
- <sup>c</sup> Non-Conductive Urethane,Dam,Primer - 1 Tube

- M Coupe 2 Door Coupe** ..... 2006-2008
- Z4 2 Door Coupe** ..... 2006-2008

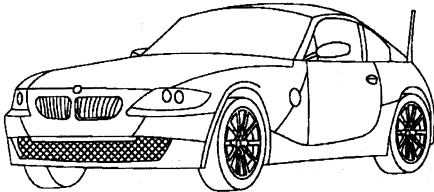

- FW02620<sup>a</sup>** Windshield (Rain Sensor) ..... 38.1x58.0
- FW02619<sup>a</sup>** Windshield ..... 38.1x58.0
- FD22894-95** Door F/R-L ..... 15.0x33.0
- FQ23288-89<sup>c</sup>** Quarter R-L (Encap) ..... 10.5x12.0
- FB23245<sup>b</sup>** Back Window (Heated) ..... 16.7x43.0
- <sup>a</sup> Non-Conductive Urethane,Dam,Primer - 2 Tubes
- <sup>b</sup> Non-Conductive Urethane,Dam,Primer - 1.5 Tubes
- <sup>c</sup> Non-Conductive Urethane,Dam,Primer - 1 Tube

- M Roadster 2 Door Convertible** ..... 2006-2008
- Z4 2 Door Convertible** ..... 2006-2008

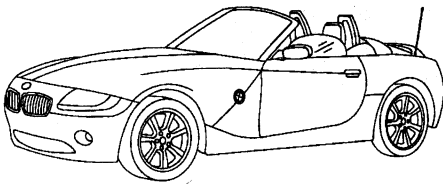

- FW02350<sup>a</sup>** Windshield (Rain Sensor) ..... 38.1x58.0
- FW02349<sup>a</sup>** Windshield ..... 38.1x58.0
- FD21804-05** Door F/R-L (1 Holes) ..... 19.0x33.0
- FB24349<sup>b</sup>** Back Window (Heated)(Removable Hardtop) .....
- <sup>a</sup> Non-Conductive Urethane,Dam,Primer - 2 Tubes
- <sup>b</sup> Non-Conductive Urethane,Dam,Primer - 1.5 Tubes

**X1 4 Door Utility ..... 2011**

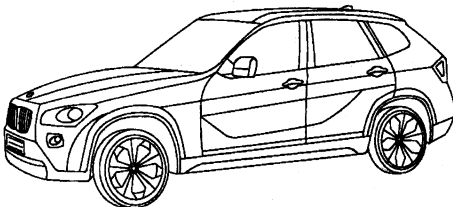

- FW03230<sup>a</sup>** Windshield (Solar) ..... 34.1x57.8
- FD24626-27** Door F/R-L (2 Holes)(Solar) ..... 21.2x27.2
- FD24628-29** Door R/R-L (1 Holes)(Solar) ..... 20.0x21.1
- FQ24632-33<sup>b</sup>** Quarter R-L (Encap)(Solar) ..... 11.2x14.6
- FV24630-31** Vent R/R-L (Solar) ..... 11.2x14.6
- FB24634<sup>b</sup>** Back Window (Heated)(Solar) .....
- <sup>a</sup> Non-Conductive Urethane,Dam,Primer - 2 Tubes
- <sup>b</sup> Non-Conductive Urethane,Dam,Primer - 1.5 Tubes

**X3 4 Door Utility ..... 2011**

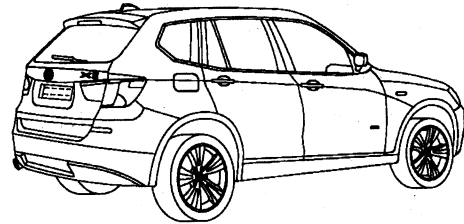

- FW03308<sup>a b</sup>** Windshield (HUD)(Solar) (W/Third Visor Frit, Solar Coated, Rain Sensor) .....
- FW03307<sup>a b</sup>** Windshield (HUD)(Solar) (W/Third Visor Frit, Rain Sensor) .....
- FW03306<sup>a b</sup>** Windshield (Solar) (W/Third Visor Frit, Solar Coated, Rain Sensor) .....
- FW03305<sup>a b</sup>** Windshield (Solar) (W/Third Visor Frit, Rain Sensor) .....
- FW03304<sup>b</sup>** Windshield (Solar) (W/Third Visor Frit) .....
- FD24790-91** Door F/R-L (Solar) .....
- FD24792-93** Door R/R-L (Solar) .....
- FQ24796-97<sup>c</sup>** Quarter R-L (Encap)(Solar) .....
- FV24794-95** Vent R/R-L (Solar) .....
- FB24798<sup>c</sup>** Back Window (Ant)(Solar) .....
- <sup>a</sup> Rain Sensor Kit
- <sup>b</sup> Non-Conductive Urethane,Dam,Primer - 2 Tubes
- <sup>c</sup> Non-Conductive Urethane,Dam,Primer - 1.5 Tubes

**X3 4 Door Utility ..... 2006-2010**

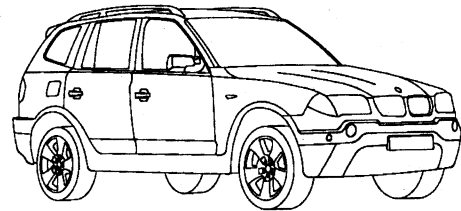

- FW02468<sup>a</sup>** Windshield ..... 35.0x61.0
- FW02460<sup>a</sup>** Windshield (Rain Sensor) ..... 35.0x61.0
- FD22271-72** Door F/R-L (2 Holes)(Solar) ..... 25.5x36.0
- FD22273-74** Door R/R-L (1 Holes)(Solar) ..... 24.5x25.5
- FQ22315-16<sup>c</sup>** Quarter R-L (Encap) (Glossy Black) ..... 14.5x19.5
- FQ22277-78<sup>c</sup>** Quarter R-L (Encap) (Flat Black) ..... 14.5x19.5
- FV22275-76<sup>c</sup>** Vent R/R-L ..... 11.5x17.5
- FB22279<sup>b</sup>** Back Window (Heated)(1 Holes) (W/Wiper) ..... 20.0x49.5
- <sup>a</sup> Non-Conductive Urethane,Dam,Primer - 2 Tubes
- <sup>b</sup> Non-Conductive Urethane,Dam,Primer - 1.5 Tubes
- <sup>c</sup> Non-Conductive Urethane,Dam,Primer - 1 Tube

**X5 4 Door Utility ..... 2007-2011**



- FW02821<sup>a b</sup>** Windshield (HUD)(Solar) (Solar Coated, Rain Sensor) ..... 38.3x63.0

**X5 (cont.)**

|                         |   |           |
|-------------------------|---|-----------|
| FW02757 <sup>a b</sup>  | Windshield (HUD)(Solar) (Rain Sensor)                                     | 38.3x63.0 |
| FW02733 <sup>a b</sup>  | Windshield (Solar) (Solar Coated, Rain Sensor)                            | 38.3x63.0 |
| FW02732 <sup>b</sup>    | Windshield (Solar) (Solar Coated)   | 38.3x63.0 |
| FW02731 <sup>a b</sup>  | Windshield (Solar) (Rain Sensor)  | 38.3x63.0 |
| FW02730 <sup>b</sup>    | Windshield (Solar)  | 38.3x63.0 |
| FD23378-79              | Door F/R-L (2 Holes)(Solar)   | 24.8x38.8 |
| FD23380-81              | Door R/R-L (Solar)  | 24.5x25.4 |
| FQ23384-85 <sup>c</sup> | Quarter R-L (Encap)(Solar)  | 20.0x20.5 |
| FV23382-83              | Vent R/R-L (Solar)  | 12.7x19.2 |
| FB23386 <sup>b</sup>    | Back Window (Ant)(Heated)(3 Holes)(Solar) (W/ Diversity Antenna, W/Wiper) | 25.3x59.0 |

<sup>a</sup> May Require Replacement of Rain Sensor  
<sup>b</sup> Non-Conductive Urethane,Dam,Primer - 2 Tubes  
<sup>c</sup> Non-Conductive Urethane,Dam,Primer - 1 Tube

**X5 4 Door Utility ..... 2006**

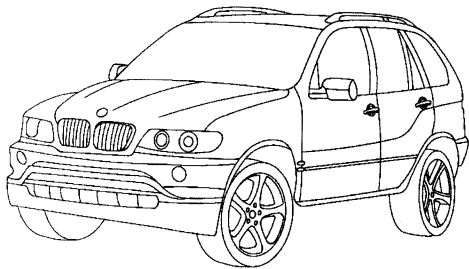

|                         |  |           |
|-------------------------|--|-----------|
| FW02383 <sup>a</sup>    | Windshield (Rain Sensor)                       | 37.0x61.3 |
| FW02382 <sup>a</sup>    | Windshield (Solar) (Solar Coated, Rain Sensor) | 37.0x61.3 |
| FW02138 <sup>a</sup>    | Windshield (Solar) (Solar Coated)              | 37.0x61.3 |
| FW02137 <sup>a</sup>    | Windshield                                     | 37.0x61.3 |
| FD20920-21              | Door F/R-L (2 Holes)                           | 24.0x39.0 |
| FD20922-23              | Door R/R-L (1 Holes) (W/O Insulated Glass)     | 21.0x25.0 |
| FQ20927 <sup>c</sup>    | Quarter L (Ant)(Encap)                         | 18.0x23.0 |
| FQ20926 <sup>c</sup>    | Quarter R (Encap)                              | 18.0x23.0 |
| FV20924-25 <sup>c</sup> | Vent R/R-L (W/O Insulated Glass)               | 11.8x19.0 |
| FB20928 <sup>b</sup>    | Back Window (Ant)(Heated)(1 Holes)             | 23.0x34.5 |

<sup>a</sup> Non-Conductive Urethane,Dam,Primer - 2 Tubes  
<sup>b</sup> Non-Conductive Urethane,Dam,Primer - 1.5 Tubes  
<sup>c</sup> Non-Conductive Urethane,Dam,Primer - 1 Tube

**X6 4 Door Utility ..... 2008-2011**

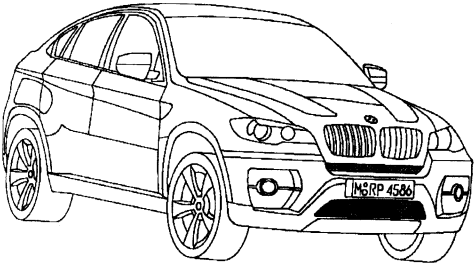

|                      |   |           |
|----------------------|---|-----------|
| FW03201 <sup>a</sup> | Windshield (HUD)(Solar) (W/Lane Departure Warning System, Rain Sensor, Condensation Sensor) (09-11) | 38.3x62.6 |
| FW03180 <sup>a</sup> | Windshield (HUD)(Solar) (Rain Sensor, Condensation Sensor) (09-11)                                  | 38.3x62.6 |
| FW03179 <sup>a</sup> | Windshield (Solar) (Rain Sensor, Condensation Sensor) (09-11)                                       | 38.3x62.6 |
| FW02936 <sup>a</sup> | Windshield (HUD)(Solar) (Rain Sensor, Condensation Sensor) (08)                                     | 38.3x62.6 |

**X6 (cont.)**

|                         |  |           |
|-------------------------|--|-----------|
| FW02935 <sup>a</sup>    | Windshield (Solar) (Rain Sensor, Condensation Sensor) (08) | 38.3x62.6 |
| FW02934 <sup>a</sup>    | Windshield (Solar) (08)                                    | 38.3x62.6 |
| FD23816-17              | Door F/R-L (Solar)   | 20.0x30.0 |
| FD23818-19              | Door R/R-L (1 Holes)(Solar)                                | 19.0x24.0 |
| FQ23902-03 <sup>c</sup> | Quarter R-L (Encap)(Solar) (Black Moulding)                | 13.0x13.5 |
| FQ23822-23 <sup>c</sup> | Quarter R-L (Encap)(Solar) (Chrome Moulding)               | 13.0x13.5 |
| FV23820-21              | Vent R/R-L (Solar)   | 7.0x12.0  |
| FB23824 <sup>b</sup>    | Back Window (Heated)(Solar)                                | 28.0x47.5 |

<sup>a</sup> Non-Conductive Urethane,Dam,Primer - 2 Tubes  
<sup>b</sup> Non-Conductive Urethane,Dam,Primer - 1.5 Tubes  
<sup>c</sup> Non-Conductive Urethane,Dam,Primer - 1 Tube

**Z4 2 Door Convertible ..... 2009-2011**

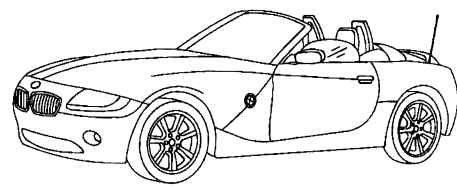

|                        |                          |           |
|------------------------|--------------------------|-----------|
| FW03113 <sup>a b</sup> | Windshield (Rain Sensor) | 31.5x56.0 |
| FW03112 <sup>b</sup>   | Windshield               | 31.5x56.0 |
| FD24344-45             | Door F/R-L               | 13.0x30.5 |
| FQ24346-47             | Quarter R-L              | 13.0x13.0 |
| FB24348 <sup>c</sup>   | Back Window (Heated)     |           |

<sup>a</sup> Rain Sensor Kit  
<sup>b</sup> Non-Conductive Urethane,Dam,Primer - 2 Tubes  
<sup>c</sup> Non-Conductive Urethane,Dam,Primer - 1.5 Tubes

**Buick Allure 4 Door Sedan ..... 2010 (CANADA Only)**

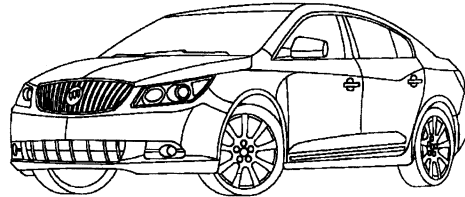

|                            |  |           |
|----------------------------|--|-----------|
| DW01850 <sup>b c d f</sup> | Windshield (HUD)(Solar) (W/Third Visor Frit, Condensation Sensor) (To 01/04/2010)                        | 36.0x56.5 |
| DW01849 <sup>a c d f</sup> | Windshield (Solar) (W/Third Visor Frit, Aftermarket, Condensation Sensor)                                | 36.0x56.5 |
| DW01823 <sup>b c d f</sup> | Windshield (HUD)(Solar) (W/Third Visor Frit, Acoustic Interlayer, Condensation Sensor) (From 01/04/2010) | 36.0x56.5 |
| DW01822 <sup>b c d f</sup> | Windshield (Solar) (W/Third Visor Frit, Acoustic Interlayer, Condensation Sensor)                        | 36.0x56.5 |
| DD11748-49                 | Door F/R-L (Solar) (Laminated)   | 17.0x32.0 |
| DD11750-51                 | Door R/R-L (Solar)   | 17.0x26.5 |
| DV11752-53                 | Vent R/R-L (Solar)   | 9.5x11.5  |
| DB11754 <sup>e</sup>       | Back Window (Ant)(Heated)(Solar)   | 32.0x44.5 |

<sup>a</sup> Not On Production Vehicles  
<sup>b</sup> On Production Vehicles  
<sup>c</sup> Urethane,Dam,Primer - 2 Tubes  
<sup>d</sup> Fast-Cure Urethane/Dam/Primer - Quantity 2  
<sup>e</sup> Urethane,Dam,Primer - 1.5 Tubes  
<sup>f</sup> Rain Sensor Kit

**Allure 4 Door Sedan ..... 2006-2009 (CANADA Only)**

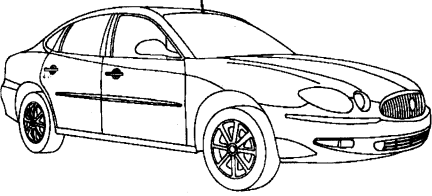

|  |           |
|--|-----------|
| DW01856 <sup>a c d</sup> Windshield (Solar) (W/Third Visor Frit, Aftermarket) (From 02/2007) (07-09) .....         | 39.0x63.5 |
| DW01855 <sup>a c d</sup> Windshield (Solar) (Aftermarket) (To 02/2007) (06-07) .....                               | 39.0x63.5 |
| DW01702 <sup>b c d</sup> Windshield (Solar) (W/Third Visor Frit, Acoustic Interlayer) (From 02/2007) (07-09) ..... | 39.0x63.5 |
| DW01607 <sup>b c d</sup> Windshield (Solar) (Acoustic Interlayer) (To 02/2007) (06-07) .....                       | 39.0x63.5 |
| DD10884-85 Door F/R-L (Solar) (Laminated) .....  | 21.6x34.9 |
| DD10886-87 Door R/R-L (Solar) .....  | 21.3x28.6 |
| DQ10888-89 <sup>e</sup> Quarter R-L (Encap)(Solar) .....   | 7.8x10.5  |
| DB10891 <sup>c</sup> Back Window (Ant)(Encap)(Heated)(Solar) (W/Remote Start) .....                                | 30.7x50.8 |
| DB10890 <sup>c</sup> Back Window (Ant)(Encap)(Heated)(Solar) .....   | 30.7x50.8 |

<sup>a</sup> Not On Production Vehicles  
<sup>b</sup> On Production Vehicles  
<sup>c</sup> Urethane,Dam,Primer - 2 Tubes  
<sup>d</sup> Fast-Cure Urethane/Dam/Primer - Quantity 2  
<sup>e</sup> Urethane,Dam,Primer - 1 Tube

**Enclave 4 Door Utility ..... 2008-2011**

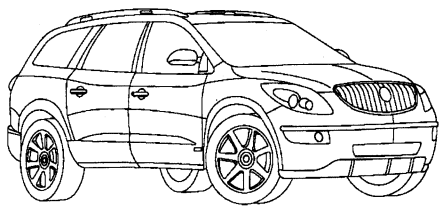

|   |           |
|---|-----------|
| DW01794 <sup>a c d</sup> Windshield (Solar) (W/Third Visor Frit, Aftermarket) .....         | 40.0x64.0 |
| DW01681 <sup>b c d</sup> Windshield (Solar) (W/Third Visor Frit, Acoustic Interlayer) ..... | 40.0x64.0 |
| DD11277-78 Door F/R-L (Solar) (Laminated) .....   | 27.5x31.5 |
| DD11279-80 Door R/R-L (Solar) .....   | 24.0x25.0 |
| DQ11283-84 <sup>f</sup> Quarter R-L (Encap)(Solar) .....                                    | 16.5x33.0 |
| DV11514-15 Vent R/R-L (Solar) .....   | 8.0x17.0  |
| DB11285 <sup>e</sup> Back Window (Heated)(1 Holes)(Solar) (W/Wiper) ..                      | 21.0x57.0 |

<sup>a</sup> Not On Production Vehicles  
<sup>b</sup> On Production Vehicles  
<sup>c</sup> Urethane,Dam,Primer - 2 Tubes  
<sup>d</sup> Fast-Cure Urethane/Dam/Primer - Quantity 2  
<sup>e</sup> Urethane,Dam,Primer - 1.5 Tubes  
<sup>f</sup> Urethane,Dam,Primer - 1 Tube

**LaCrosse 4 Door Sedan ..... 2010-2011**

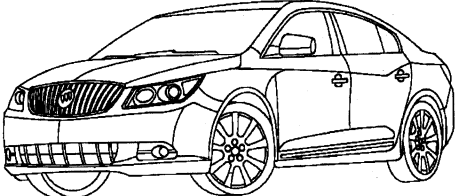

**LaCrosse (cont.)**

|   |           |
|---|-----------|
| DW01850 <sup>b c d f</sup> Windshield (HUD)(Solar) (W/Third Visor Frit, Condensation Sensor) (To 01/04/2010) (10) .....                   | 36.0x56.5 |
| DW01849 <sup>a c d f</sup> Windshield (Solar) (W/Third Visor Frit, Aftermarket, Condensation Sensor) .....                                | 36.0x56.5 |
| DW01823 <sup>b c d f</sup> Windshield (HUD)(Solar) (W/Third Visor Frit, Acoustic Interlayer, Condensation Sensor) (From 01/04/2010) ..... | 36.0x56.5 |
| DW01822 <sup>b c d f</sup> Windshield (Solar) (W/Third Visor Frit, Acoustic Interlayer, Condensation Sensor) .....                        | 36.0x56.5 |
| DD11748-49 Door F/R-L (Solar) (Laminated) .....   | 17.0x32.0 |
| DD11750-51 Door R/R-L (Solar) .....   | 17.0x26.5 |
| DV11752-53 Vent R/R-L (Solar) .....   | 9.5x11.5  |
| DB11754 <sup>e</sup> Back Window (Ant)(Heated)(Solar) .....   | 32.0x44.5 |

<sup>a</sup> Not On Production Vehicles  
<sup>b</sup> On Production Vehicles  
<sup>c</sup> Urethane,Dam,Primer - 2 Tubes  
<sup>d</sup> Fast-Cure Urethane/Dam/Primer - Quantity 2  
<sup>e</sup> Urethane,Dam,Primer - 1.5 Tubes  
<sup>f</sup> Rain Sensor Kit

**LaCrosse 4 Door Sedan ..... 2006-2009 (USA Only)**

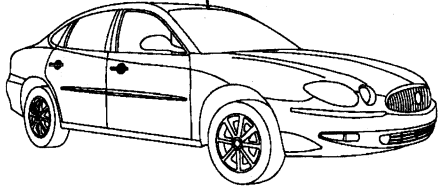

|  |           |
|--|-----------|
| DW01856 <sup>a c d</sup> Windshield (Solar) (W/Third Visor Frit, Aftermarket) (From 02/2007) (07-09) .....         | 39.0x63.5 |
| DW01855 <sup>a c d</sup> Windshield (Solar) (Aftermarket) (To 02/2007) (06-07) .....                               | 39.0x63.5 |
| DW01702 <sup>b c d</sup> Windshield (Solar) (W/Third Visor Frit, Acoustic Interlayer) (From 02/2007) (07-09) ..... | 39.0x63.5 |
| DW01607 <sup>b c d</sup> Windshield (Solar) (Acoustic Interlayer) (To 02/2007) (06-07) .....                       | 39.0x63.5 |
| DD10884-85 Door F/R-L (Solar) (Laminated) .....  | 21.6x34.9 |
| DD10886-87 Door R/R-L (Solar) .....  | 21.3x28.6 |
| DQ10888-89 <sup>e</sup> Quarter R-L (Encap)(Solar) .....   | 7.8x10.5  |
| DB10891 <sup>c</sup> Back Window (Ant)(Encap)(Heated)(Solar) (W/Remote Start) .....                                | 30.7x50.8 |
| DB10890 <sup>c</sup> Back Window (Ant)(Encap)(Heated)(Solar) .....   | 30.7x50.8 |

<sup>a</sup> Not On Production Vehicles  
<sup>b</sup> On Production Vehicles  
<sup>c</sup> Urethane,Dam,Primer - 2 Tubes  
<sup>d</sup> Fast-Cure Urethane/Dam/Primer - Quantity 2  
<sup>e</sup> Urethane,Dam,Primer - 1 Tube

**Lucerne 4 Door Sedan ..... 2006-2011**

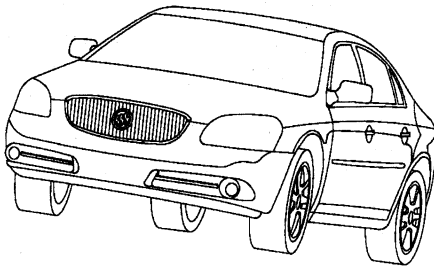

|   |           |
|---|-----------|
| DW01888 <sup>a b</sup> Windshield (Solar) (PAAS System, W/Lane Departure Warning System) (11) ..... | 38.1x61.2 |
|---|-----------|

**Lucerne**

(cont.)

|   |           |
|---|-----------|
| DW01697 <sup>a b</sup> Windshield (Solar) (PAAS System, W/Lane Departure Warning System, Rain Sensor) (07-10) ..... | 38.1x61.2 |
| DW01639 <sup>a b</sup> Windshield (Solar) (PAAS System, Rain Sensor) (06-10) .....                                  | 38.1x61.2 |
| DW01638 <sup>a b</sup> Windshield (Solar) (PAAS System) (06-10) .....   | 38.1x61.2 |
| DD11051-52 Door F/R-L (Solar) (Laminated) .....   | 22.0x36.5 |
| DD11053-54 Door R/R-L (Solar) (Laminated) .....   | 19.5x29.8 |
| DV11055-56 Vent R/R-L (Solar) .....   | 7.0x12.6  |
| DB11076 <sup>a</sup> Back Window (Ant)(Heated)(Solar) (W/Remote Start) (To 03/14/2007) (06-07) .....                | 30.0x51.6 |
| DB11057 <sup>a</sup> Back Window (Ant)(Heated)(Solar) .....   | 30.0x51.6 |

<sup>a</sup> Urethane,Dam,Primer - 2 Tubes  
<sup>b</sup> Fast-Cure Urethane/Dam/Primer - Quantity 2

**Park Avenue 4 Door Sedan ..... 2006**



|  |           |
|--|-----------|
| DW01595 <sup>a c d</sup> Windshield (HUD)(Solar) (W/Third Visor Frit, Rain Sensor) ..... | 36.8x62.8 |
| DW01594 <sup>a c d</sup> Windshield (Solar) (W/Third Visor Frit, Rain Sensor) .....      | 36.8x62.8 |
| DW01426 <sup>a b c d</sup> Windshield (Solar) .....                                      | 36.9x62.8 |
| DD09159-60 Door F/R-L (2 Holes) .....  | 23.1x36.4 |
| DD09161-62 Door R/R-L (2 Holes) .....  | 22.0x27.8 |
| DV09163-64 Vent R/R-L .....  | 20.0x30.0 |
| DB10589 <sup>c</sup> Back Window (Heated)(Solar) (W/On-Star) .....                       | 29.0x55.0 |
| DB09165 <sup>c</sup> Back Window (Heated)(Solar) .....                                   | 29.0x55.0 |

<sup>a</sup> May Require Two Person Installation  
<sup>b</sup> When Interchanging With DW01296 With Rain Sensor, May Require Rain Sensor Kit  
<sup>c</sup> Urethane,Dam,Primer - 2 Tubes  
<sup>d</sup> Fast-Cure Urethane/Dam/Primer - Quantity 2

**Rainier 4 Door Utility ..... 2006-2007**

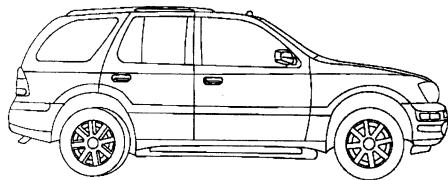

|  |           |
|--|-----------|
| DW01584 <sup>a c d</sup> Windshield (Solar) (W/Third Visor Frit) .....                       | 33.4x59.6 |
| DW01556 <sup>b c d</sup> Windshield (Solar) (W/Third Visor Frit, Acoustic Inter-layer) ..... | 33.4x59.6 |
| DD10574-75 Door F/R-L (Solar) (Laminated) .....  | 21.5x34.0 |
| DD09967-68 Door R/R-L (Solar) .....  | 18.5x21.5 |
| DQ10564-65 <sup>e</sup> Quarter R-L (Encap)(Solar) .....                                     | 18.5x34.0 |
| DV10089-90 Vent R/R-L (Encap)(Solar) .....   | 9.8x19.8  |
| DB09983 Back Window (Heated)(Solar) (Movable) .....  | 26.0x54.0 |
| DB09982 Back Window (Solar) (Movable) .....  | 26.0x54.0 |

<sup>a</sup> Not On Production Vehicles  
<sup>b</sup> On Production Vehicles  
<sup>c</sup> Urethane,Dam,Primer - 2 Tubes  
<sup>d</sup> Fast-Cure Urethane/Dam/Primer - Quantity 2  
<sup>e</sup> Urethane,Dam,Primer - 1 Tube

**Regal 4 Door Sedan ..... 2011**

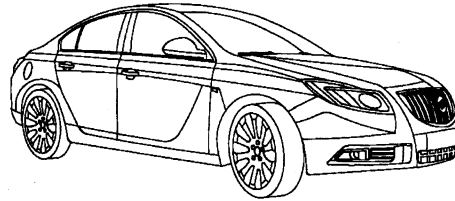

|  |  |
|--|--|
| DW01852 <sup>a b</sup> Windshield (Solar) (W/Third Visor Frit) ..... |  |
| DD11850-51 Door F/R-L (Solar) .....                                  |  |
| DD11852-53 Door R/R-L (Solar) .....                                  |  |
| DV11854-55 Vent R/R-L (Solar) .....                                  |  |

DB11856<sup>c</sup> Back Window (Ant)(Heated)(Solar) .....

<sup>a</sup> Urethane,Dam,Primer - 2 Tubes  
<sup>b</sup> Fast-Cure Urethane/Dam/Primer - Quantity 2  
<sup>c</sup> Urethane,Dam,Primer - 1.5 Tubes

**Rendezvous 4 Door Utility ..... 2006-2007**

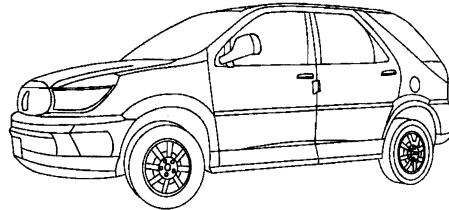

|  |           |
|--|-----------|
| DW01631 <sup>a b c</sup> Windshield (HUD)(Solar) .....   | 45.3x60.5 |
| DW01630 <sup>a b c</sup> Windshield (Solar) .....        | 45.3x60.5 |
| DD11083-84 Door F/R-L (Solar) (Laminated) .....          | 22.5x37.5 |
| DD09919-20 Door R/R-L (Solar) .....                      | 22.1x29.0 |
| DQ09921-22 <sup>e</sup> Quarter R-L (Encap)(Solar) ..... | 16.0x33.5 |
| DB09924 <sup>d</sup> Back Window (Heated)(Solar) .....   | 22.2x51.8 |

<sup>a</sup> May Require Two Person Installation  
<sup>b</sup> Urethane,Dam,Primer - 2 Tubes  
<sup>c</sup> Fast-Cure Urethane/Dam/Primer - Quantity 2  
<sup>d</sup> Urethane,Dam,Primer - 1.5 Tubes  
<sup>e</sup> Urethane,Dam,Primer - 1 Tube

**Terraza Mini Van ..... 2006-2007**

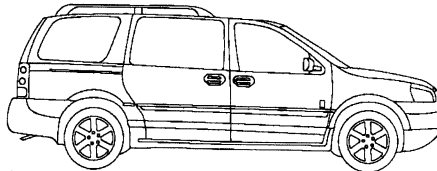

|   |           |
|---|-----------|
| DW01722 <sup>a c d</sup> Windshield (Solar) (W/Third Visor Frit) (From 06/01/2007) (07) ..... | 48.2x62.1 |
| DW01574 <sup>a c d</sup> Windshield (Solar) (To 05/31/2007) .....                             | 48.2x62.1 |
| DD10714-15 Door F/R-L (2 Holes)(Solar) .....  | 24.8x37.5 |
| DD11029-30 <sup>b</sup> Door R/R-L (Encap)(Solar) (Sliding Cargo Door) .....                  | 24.5x42.4 |
| DD10997-98 <sup>b</sup> Door R/R-L (Solar) (Sliding Cargo Door, Extended Van) .....           | 24.5x45.5 |
| DQ10851-52 Quarter R-L (Encap)(Solar) .....   | 21.5x35.0 |
| DQ10718-19 Quarter R-L (Encap)(1 Holes)(Solar) (Extended Van) .....                           |           |
| DB10868 <sup>b</sup> Back Window (Solar) .....  | 23.4x57.3 |
| DB10720 <sup>b</sup> Back Window (Heated)(1 Holes)(Solar) (W/Wiper) ...                       | 23.4x57.3 |

<sup>a</sup> May Require Two Person Installation  
<sup>b</sup> Urethane,Dam,Primer - 1.5 Tubes  
<sup>c</sup> Urethane,Dam,Primer - 2.5 Tubes  
<sup>d</sup> Fast-Cure Urethane/Dam/Primer - Quantity 2.5



**Cadillac**

**BLS 4 Door Sedan (MEXICO Only) ..... 2007-2009**

|   |                  |
|---|------------------|
| <b>FW02374<sup>a b</sup></b> Windshield (Solar) (Rain Sensor) ..... | <b>38.1x59.3</b> |
| <b>FW02373<sup>a b</sup></b> Windshield (Solar) .....               | <b>38.1x59.3</b> |
| <b>FD21887-88</b> Door F/R-L (Solar) .....                          | <b>19.6x32.0</b> |
| <b>FD23735-36</b> Door R/R-L (Solar) (Mexico Only) .....            |                  |
| <b>FV23737-38</b> Vent R/R-L (Encap)(Solar) (Mexico Only) .....     |                  |
| <b>FB21893<sup>c</sup></b> Back Window (Ant)(Heated)(Solar) .....   | <b>30.0x47.4</b> |

<sup>a</sup> Urethane,Dam,Primer - 2 Tubes  
<sup>b</sup> Fast-Cure Urethane/Dam/Primer - Quantity 2  
<sup>c</sup> Urethane,Dam,Primer - 1.5 Tubes

**CTS 2 Door Coupe ..... 2011**

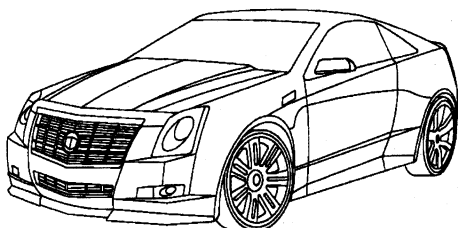

|   |                  |
|---|------------------|
| <b>DW01887<sup>b c</sup></b> Windshield (Solar) (W/Third Visor Frit) .....                        | <b>36.0x58.0</b> |
| <b>DW01841<sup>a b c</sup></b> Windshield (Solar) (W/Third Visor Frit, W/Navigation System) ..... | <b>36.0x58.0</b> |
| <b>DD11822-23</b> Door F/R-L (Solar) .....  | <b>15.0x40.5</b> |
| <b>DQ11824-25<sup>d</sup></b> Quarter R-L (Encap)(Solar) .....                                    | <b>12.0x49.5</b> |
| <b>DB11826<sup>d</sup></b> Back Window (Ant)(Heated)(Solar) .....                                 | <b>36.0x44.0</b> |

<sup>a</sup> Has 2 Mirror Buttons, One For Navigation  
<sup>b</sup> Urethane,Dam,Primer - 2 Tubes  
<sup>c</sup> Fast-Cure Urethane/Dam/Primer - Quantity 2  
<sup>d</sup> Urethane,Dam,Primer - 1.5 Tubes

**CTS 4 Door Sedan ..... 2008-2011**

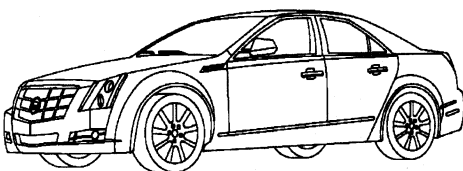

|  |                  |
|--|------------------|
| <b>DW01740<sup>a b</sup></b> Windshield (Solar) (Rain Sensor) (08-09) .....      | <b>37.0x58.5</b> |
| <b>DW01739<sup>a b</sup></b> Windshield (Solar) .....                            | <b>37.0x58.5</b> |
| <b>DD11506-07</b> Door F/R-L (Solar) .....                                       | <b>16.0x30.0</b> |
| <b>DD11508-09</b> Door R/R-L (Solar) .....                                       | <b>16.0x22.0</b> |
| <b>DV11512-13</b> Vent R/R-L (Solar) .....                                       | <b>7.5x 9.0</b>  |
| <b>DB11511<sup>c</sup></b> Back Window (Ant)(Heated)(Solar) (W/TV Antenna) ..... | <b>28.0x45.0</b> |
| <b>DB11510<sup>c</sup></b> Back Window (Ant)(Heated)(Solar) .....                | <b>28.0x45.0</b> |

<sup>a</sup> Urethane,Dam,Primer - 2 Tubes  
<sup>b</sup> Fast-Cure Urethane/Dam/Primer - Quantity 2  
<sup>c</sup> Urethane,Dam,Primer - 1.5 Tubes

**CTS 4 Door Sedan ..... 2006-2007**

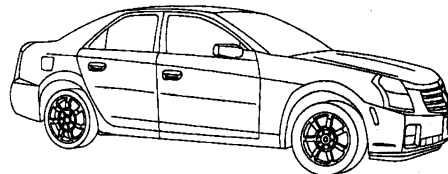

|   |                  |
|---|------------------|
| <b>DW01479<sup>a b</sup></b> Windshield (Ant)(Solar) .....                                    | <b>37.3x59.2</b> |
| <b>DD10125-26</b> Door F/R-L (Solar) .....  | <b>21.5x37.2</b> |
| <b>DD10127-28</b> Door R/R-L (Solar) .....  | <b>20.2x26.0</b> |
| <b>DV10152-53</b> Vent R/R-L (Encap)(Solar) .....   | <b>9.5x10.2</b>  |
| <b>DB10130<sup>a</sup></b> Back Window (Heated)(Solar) (W/On-Star, PAAS System 3 Sides) ..... | <b>34.6x49.0</b> |
| <b>DB10129<sup>a</sup></b> Back Window (Heated)(Solar) (PAAS System 3 Sides) .....            | <b>34.6x49.0</b> |

<sup>a</sup> Urethane,Dam,Primer - 2 Tubes  
<sup>b</sup> Fast-Cure Urethane/Dam/Primer - Quantity 2

**CTS 4 Door Station Wagon ..... 2010-2011**

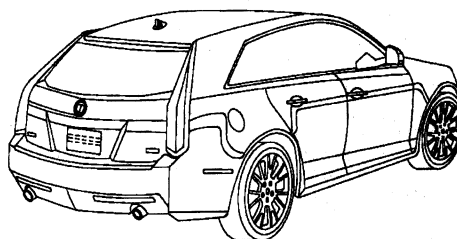

|   |                  |
|---|------------------|
| <b>DW01739<sup>a b</sup></b> Windshield (Solar) .....             | <b>37.0x58.5</b> |
| <b>DD11506-07</b> Door F/R-L (Solar) .....                        | <b>16.0x30.0</b> |
| <b>DD11508-09</b> Door R/R-L (Solar) .....                        | <b>16.0x22.0</b> |
| <b>DQ11755-56<sup>d</sup></b> Quarter R-L (Encap)(Solar) .....    | <b>13.0x31.0</b> |
| <b>DV11512-13</b> Vent R/R-L (Solar) .....                        | <b>7.5x 9.0</b>  |
| <b>DB11757<sup>c</sup></b> Back Window (Ant)(Heated)(Solar) ..... | <b>16.5x47.5</b> |

<sup>a</sup> Urethane,Dam,Primer - 2 Tubes  
<sup>b</sup> Fast-Cure Urethane/Dam/Primer - Quantity 2  
<sup>c</sup> Urethane,Dam,Primer - 1.5 Tubes  
<sup>d</sup> Urethane,Dam,Primer - 1 Tube

**DTS 4 Door Sedan ..... 2006-2011**

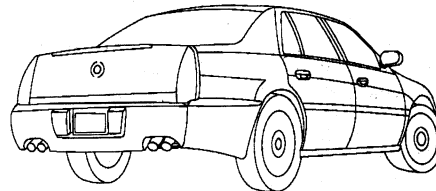

|  |                  |
|--|------------------|
| <b>DW01718<sup>a b</sup></b> Windshield (Solar) (W/Third Visor Frit, W/Lane Departure Warning System, Rain Sensor) (07-11) ..... | <b>42.0x64.0</b> |
| <b>DW01635<sup>a b</sup></b> Windshield (Ant)(Solar) (W/Third Visor Frit, Rain Sensor, W/Remote Start) .....                     | <b>42.0x64.0</b> |
| <b>DW01634<sup>a b</sup></b> Windshield (Ant)(Solar) (W/Third Visor Frit, W/Remote Start) .....                                  | <b>42.0x64.0</b> |
| <b>DD11020-21</b> Door F/R-L (Solar) (Laminated) .....   | <b>22.0x33.8</b> |
| <b>DD11022-23</b> Door R/R-L (Solar) (Laminated) .....   | <b>22.0x25.5</b> |
| <b>DV11024-25</b> Vent R/R-L (Encap)(Solar) .....  | <b>13.0x15.8</b> |
| <b>DB11082<sup>c</sup></b> Back Window (Ant)(Encap)(Heated)(Solar) (W/Diversity Antenna, W/Remote Start) .....                   | <b>26.0x55.0</b> |
| <b>DB11026<sup>a</sup></b> Back Window (Ant)(Encap)(Heated)(Solar) (W/Diversity Antenna) .....                                   | <b>30.0x56.5</b> |

**DTS (cont.)**

- <sup>a</sup> Urethane,Dam,Primer - 2 Tubes
- <sup>b</sup> Fast-Cure Urethane/Dam/Primer - Quantity 2
- <sup>c</sup> Urethane,Dam,Primer - 1.5 Tubes

**Escalade 4 Door Utility ..... 2007-2011**

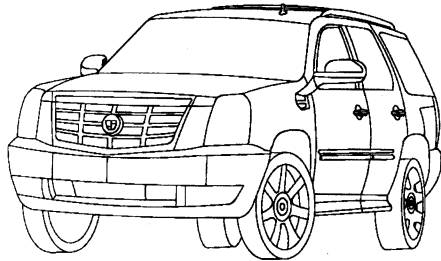

|   |           |
|---|-----------|
| DW01883 <sup>b e f</sup> Windshield (Solar) (W/Third Visor Frit, Acoustic Inter-layer) (11) ..... | 31.0x67.0 |
| DW01659 <sup>a e f</sup> Windshield (Solar) (W/Third Visor Frit, Rain Sensor) .....               | 33.5x67.8 |
| DW01658 <sup>c d e f</sup> Windshield (Solar) (W/Third Visor Frit) .....                          | 33.5x67.8 |
| DD11253-54 Door F/R-L (Solar) .....   | 26.8x32.5 |
| DD11255-56 Door R/R-L (Solar) .....   | 26.8x29.0 |
| DQ11168 <sup>g</sup> Quarter L (Solar) .....  | 20.8x42.3 |
| DQ11167 <sup>g</sup> Quarter R (Ant)(Solar) .....   | 20.8x42.3 |
| DB11173 Back Window (Heated)(3 Holes)(Solar) .....  | 25.0x61.5 |

- <sup>a</sup> May Require Replacement of Rain Sensor
- <sup>b</sup> On Production Vehicles
- <sup>c</sup> Not On Production Vehicles 2011 Up
- <sup>d</sup> On Production Vehicles 2007-2010
- <sup>e</sup> Urethane,Dam,Primer - 2 Tubes
- <sup>f</sup> Fast-Cure Urethane/Dam/Primer - Quantity 2
- <sup>g</sup> Urethane,Dam,Primer - 1.5 Tubes

**Escalade 4 Door Utility ..... 2006**

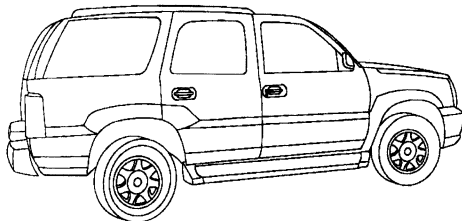

|   |           |
|---|-----------|
| DW01736 <sup>a c d</sup> Windshield (Solar) (W/Third Visor Frit, Aftermarket, Solar Coated) ..... | 31.5x69.1 |
| DW01549 <sup>b c d</sup> Windshield (Solar) (W/Third Visor Frit) .....                            | 31.5x69.1 |
| DD10229-30 Door F/R-L (Solar) (Laminated) .....   | 26.4x32.2 |
| DD09479-80 Door F/R-L (Solar) .....   | 26.4x32.4 |
| DD10231-32 Door R/R-L (Solar) (Laminated) .....   | 23.5x32.0 |
| DD09738-39 Door R/R-L (Solar) .....   | 23.5x32.0 |
| DR11694 Roof (Solar) .....  |           |
| DQ10046 <sup>e</sup> Quarter L (Ant)(Encap)(Solar) (W/Diversity Antenna) .....                    | 21.3x44.0 |
| DQ10044 <sup>e</sup> Quarter R (Ant)(Encap)(Solar) (W/Diversity Antenna) .....                    | 21.3x44.0 |
| DB10828 Back Window (Heated)(3 Holes)(Solar) (Bermuda Blue) .....                                 | 28.0x60.0 |
| DB10827 Back Window (Heated)(3 Holes)(Solar) (Red Metallic) .....                                 | 28.0x60.0 |
| DB10826 Back Window (Heated)(3 Holes)(Solar) (Silver Birch) .....                                 | 28.0x60.0 |
| DB10825 Back Window (Heated)(3 Holes)(Solar) (Ming Blue) .....                                    | 28.0x60.0 |
| DB10824 Back Window (Heated)(3 Holes)(Solar) (Diamond White) .....                                | 28.0x60.0 |
| DB10823 Back Window (Heated)(3 Holes)(Solar) (Black) .....  | 28.0x60.0 |

<sup>a</sup> Not On Production Vehicles

**Escalade (cont.)**

- <sup>b</sup> On Production Vehicles
- <sup>c</sup> Urethane,Dam,Primer - 2 Tubes
- <sup>d</sup> Fast-Cure Urethane/Dam/Primer - Quantity 2
- <sup>e</sup> Urethane,Dam,Primer - 1.5 Tubes

**Escalade ESV 4 Door Utility ..... 2007-2011**

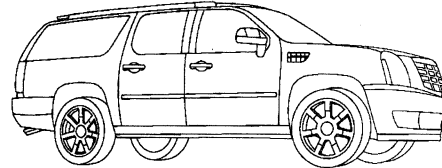

|   |           |
|---|-----------|
| DW01883 <sup>b e f</sup> Windshield (Solar) (W/Third Visor Frit, Acoustic Inter-layer) (11) ..... | 31.0x67.0 |
| DW01659 <sup>a e f</sup> Windshield (Solar) (W/Third Visor Frit, Rain Sensor) .....               | 33.5x67.8 |
| DW01658 <sup>c d e f</sup> Windshield (Solar) (W/Third Visor Frit) .....                          | 33.5x67.8 |
| DD11253-54 Door F/R-L (Solar) .....   | 26.8x32.5 |
| DD11257-58 Door R/R-L (Solar) .....   | 27.0x29.8 |
| DQ11172 <sup>e</sup> Quarter L (Solar) .....  | 21.0x60.5 |
| DQ11171 <sup>e</sup> Quarter R (Ant)(Solar) .....   | 21.0x60.5 |
| DB11173 Back Window (Heated)(3 Holes)(Solar) .....  | 25.0x61.5 |

- <sup>a</sup> May Require Replacement of Rain Sensor
- <sup>b</sup> On Production Vehicles
- <sup>c</sup> Not On Production Vehicles 2011 Up
- <sup>d</sup> On Production Vehicles 2007-2010
- <sup>e</sup> Urethane,Dam,Primer - 2 Tubes
- <sup>f</sup> Fast-Cure Urethane/Dam/Primer - Quantity 2

**Escalade ESV 4 Door Utility ..... 2006**

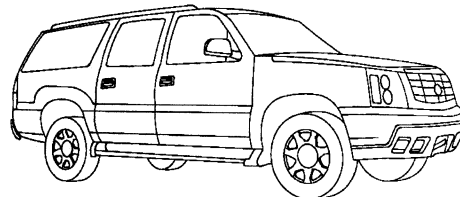

|   |           |
|---|-----------|
| DW01736 <sup>a c d</sup> Windshield (Solar) (W/Third Visor Frit, Aftermarket, Solar Coated) ..... | 31.5x69.1 |
| DW01549 <sup>b c d</sup> Windshield (Solar) (W/Third Visor Frit) .....                            | 31.5x69.1 |
| DD09479-80 Door F/R-L (Solar) .....   | 26.4x32.4 |
| DD09734-35 Door R/R-L (Solar) .....   | 26.1x30.1 |
| DR11694 Roof (Solar) .....  |           |
| DQ10578-79 <sup>e</sup> Quarter R-L (Ant)(Encap)(Solar) .....                                     | 22.0x54.0 |
| DB10828 Back Window (Heated)(3 Holes)(Solar) (Bermuda Blue) .....                                 | 28.0x60.0 |
| DB10827 Back Window (Heated)(3 Holes)(Solar) (Red Metallic) .....                                 | 28.0x60.0 |
| DB10826 Back Window (Heated)(3 Holes)(Solar) (Silver Birch) .....                                 | 28.0x60.0 |
| DB10825 Back Window (Heated)(3 Holes)(Solar) (Ming Blue) .....                                    | 28.0x60.0 |
| DB10824 Back Window (Heated)(3 Holes)(Solar) (Diamond White) .....                                | 28.0x60.0 |
| DB10823 Back Window (Heated)(3 Holes)(Solar) (Black) .....  | 28.0x60.0 |

- <sup>a</sup> Not On Production Vehicles
- <sup>b</sup> On Production Vehicles
- <sup>c</sup> Urethane,Dam,Primer - 2 Tubes
- <sup>d</sup> Fast-Cure Urethane/Dam/Primer - Quantity 2
- <sup>e</sup> Urethane,Dam,Primer - 1.5 Tubes

**Escalade EXT 4 Door Crew Cab ..... 2007-2011**

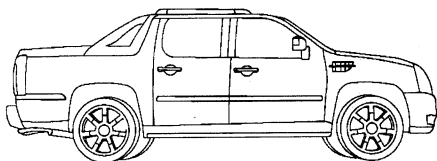

|   |                  |
|---|------------------|
| <b>DW01883<sup>b e f</sup></b> Windshield (Solar) (W/Third Visor Frit, Acoustic Inter-layer) (11) ..... | <b>31.0x67.0</b> |
| <b>DW01659<sup>a e f</sup></b> Windshield (Solar) (W/Third Visor Frit, Rain Sensor) .....               | <b>33.5x67.8</b> |
| <b>DW01658<sup>d e f</sup></b> Windshield (Solar) (W/Third Visor Frit) .....                            | <b>33.5x67.8</b> |
| <b>DD11253-54</b> Door F/R-L (Solar) .....  | <b>26.8x32.5</b> |
| <b>DD11257-58</b> Door R/R-L (Solar) .....  | <b>27.0x29.8</b> |
| <b>DB10062</b> Back Window (Encap)(Heated)(Solar) .....   | <b>12.0x51.0</b> |

<sup>a</sup> May Require Replacement of Rain Sensor  
<sup>b</sup> On Production Vehicles  
<sup>c</sup> Not On Production Vehicles 2011 Up  
<sup>d</sup> On Production Vehicles 2007-2010  
<sup>e</sup> Urethane,Dam,Primer - 2 Tubes  
<sup>f</sup> Fast-Cure Urethane/Dam/Primer - Quantity 2

**Escalade EXT 4 Door Crew Cab ..... 2006**

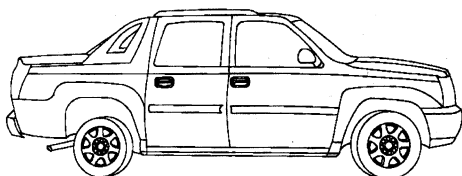

|   |                  |
|---|------------------|
| <b>DW01736<sup>a c d</sup></b> Windshield (Solar) (W/Third Visor Frit, Aftermarket, Solar Coated) ..... | <b>31.5x69.1</b> |
| <b>DW01549<sup>b c d</sup></b> Windshield (Solar) (W/Third Visor Frit) .....                            | <b>31.5x69.1</b> |
| <b>DD09479-80</b> Door F/R-L (Solar) .....  | <b>26.4x32.4</b> |
| <b>DD09734-35</b> Door R/R-L (Solar) .....  | <b>26.1x30.1</b> |
| <b>DR11694</b> Roof (Solar) .....   | <b>26.1x30.1</b> |
| <b>DB10062</b> Back Window (Encap)(Heated)(Solar) .....   | <b>12.0x51.0</b> |

<sup>a</sup> Not On Production Vehicles  
<sup>b</sup> On Production Vehicles  
<sup>c</sup> Urethane,Dam,Primer - 2 Tubes  
<sup>d</sup> Fast-Cure Urethane/Dam/Primer - Quantity 2

**SRX 4 Door Utility ..... 2010-2011**

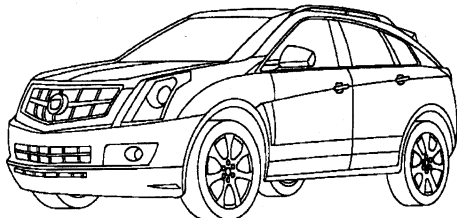

|   |                  |
|---|------------------|
| <b>DW01817<sup>a b</sup></b> Windshield (Solar) (Rain Sensor) .....                 | <b>36.0x54.0</b> |
| <b>DW01816<sup>a b</sup></b> Windshield (Solar) .....                               | <b>36.0x54.0</b> |
| <b>DD11739-40</b> Door F/R-L (Solar) (Laminated) .....                              | <b>19.0x31.0</b> |
| <b>DD11741-42</b> Door R/R-L (Solar) .....  | <b>19.0x27.5</b> |
| <b>DQ11745-46<sup>d</sup></b> Quarter R-L (Ant)(Encap)(Solar) (W/Theft Alarm) ..... | <b>14.0x15.0</b> |
| <b>DQ11743-44<sup>d</sup></b> Quarter R-L (Encap)(Solar) .....                      | <b>14.0x15.0</b> |
| <b>DB11747<sup>c</sup></b> Back Window (Heated)(1 Holes)(Solar) .....               | <b>22.0x52.0</b> |

<sup>a</sup> Urethane,Dam,Primer - 2 Tubes  
<sup>b</sup> Fast-Cure Urethane/Dam/Primer - Quantity 2  
<sup>c</sup> Urethane,Dam,Primer - 1.5 Tubes  
<sup>d</sup> Urethane,Dam,Primer - 1 Tube

**SRX 4 Door Utility ..... 2006-2009**

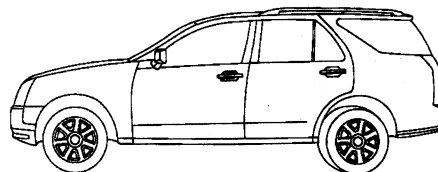

|   |                  |
|---|------------------|
| <b>DW01636<sup>a b</sup></b> Windshield (Ant)(Solar) (PAAS System, W/Phone Antenna) ..... | <b>37.0x60.5</b> |
| <b>DW01530<sup>a b</sup></b> Windshield (Solar) (PAAS System) .....                       | <b>37.0x60.5</b> |
| <b>DD10476-77</b> Door F/R-L (Solar) .....  | <b>21.0x34.0</b> |
| <b>DD10478-79</b> Door R/R-L (Solar) .....  | <b>22.0x23.0</b> |
| <b>DQ10484<sup>c</sup></b> Quarter R (Ant)(Solar) (W/On-Star) .....                       | <b>15.5x40.5</b> |
| <b>DQ10482-83<sup>c</sup></b> Quarter R-L (Ant)(Solar) .....                              | <b>15.5x40.5</b> |
| <b>DV10480-81</b> Vent R/R-L (Encap)(Solar) .....   | <b>13.0x17.5</b> |
| <b>DB10485<sup>c</sup></b> Back Window (Heated)(Solar) (PAAS System) .....                | <b>18.5x57.8</b> |

<sup>a</sup> Urethane,Dam,Primer - 2 Tubes  
<sup>b</sup> Fast-Cure Urethane/Dam/Primer - Quantity 2  
<sup>c</sup> Urethane,Dam,Primer - 1.5 Tubes

**STS 4 Door Sedan ..... 2006-2011**

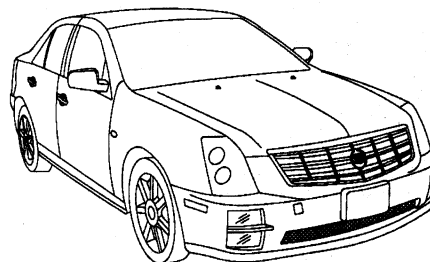

|   |                  |
|---|------------------|
| <b>DW01847<sup>b c d</sup></b> Windshield (Solar) (PAAS System, Acoustic Interlayer, W/Lane Departure Warning System, Rain Sensor) (08-11) .....      | <b>36.6x59.1</b> |
| <b>DW01846<sup>b c d</sup></b> Windshield (HUD)(Solar) (PAAS System, Acoustic Interlayer, W/Lane Departure Warning System, Rain Sensor) (08-11) ..... | <b>36.6x59.1</b> |
| <b>DW01717<sup>a c d</sup></b> Windshield (HUD)(Solar) (Acoustic Interlayer, Aftermarket, Rain Sensor) (06-07) .....                                  | <b>36.6x59.1</b> |
| <b>DW01716<sup>a c d</sup></b> Windshield (Solar) (Aftermarket, Rain Sensor) .....  | <b>36.6x59.1</b> |
| <b>DW01715<sup>a c d</sup></b> Windshield (Solar) (Aftermarket) .....   | <b>36.6x59.1</b> |
| <b>DW01602<sup>b c d</sup></b> Windshield (HUD)(Solar) (PAAS System, Acoustic Interlayer, Rain Sensor) (06-07) .....                                  | <b>36.6x59.1</b> |
| <b>DW01601<sup>b c d</sup></b> Windshield (Solar) (PAAS System, Acoustic Interlayer, Rain Sensor) .....   | <b>36.6x59.1</b> |
| <b>DW01600<sup>b c d</sup></b> Windshield (Solar) (PAAS System, Acoustic Interlayer) .....  | <b>36.6x59.1</b> |
| <b>DD10833-34</b> Door F/R-L (Solar) (Laminated) .....  | <b>22.1x35.7</b> |
| <b>DD10835-36</b> Door R/R-L (Solar) .....  | <b>21.0x22.8</b> |
| <b>DV10837-38</b> Vent R/R-L (Solar) .....  | <b>12.2x13.9</b> |
| <b>DB10839<sup>c</sup></b> Back Window (PAAS System 3 Sides) .....  | <b>36.4x52.2</b> |

<sup>a</sup> Not On Production Vehicles  
<sup>b</sup> On Production Vehicles  
<sup>c</sup> Urethane,Dam,Primer - 2 Tubes  
<sup>d</sup> Fast-Cure Urethane/Dam/Primer - Quantity 2

**XLR 2 Door Convertible..... 2006-2009**

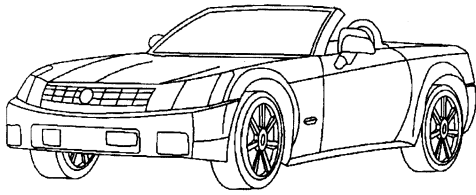

|   |                  |
|---|------------------|
| <b>DW01617<sup>a,b</sup></b> Windshield (HUD)(Solar) (W/GPS, Rain Sensor) ..... | <b>38.5x60.0</b> |
| <b>DW01616<sup>a,b</sup></b> Windshield (Solar) (W/GPS, Rain Sensor) .....      | <b>38.5x60.0</b> |
| <b>DD10183-84</b> Door F/R-L (Solar) .....                                      | <b>18.5x40.5</b> |
| <b>DQ10185-86</b> Quarter R-L (Encap)(Solar) .....                              | <b>11.3x15.0</b> |
| <b>DB10187<sup>c</sup></b> Back Window (Heated)(Solar) (Hardtop) .....          | <b>24.0x40.5</b> |

<sup>a</sup> Urethane,Dam,Primer - 2 Tubes  
<sup>b</sup> Fast-Cure Urethane/Dam/Primer - Quantity 2  
<sup>c</sup> Urethane,Dam,Primer - 1.5 Tubes

**Avalanche (cont.)**

<sup>c</sup> Not On Production Vehicles 2011 Up  
<sup>d</sup> On Production Vehicles 2007-2010  
<sup>e</sup> Urethane,Dam,Primer - 2 Tubes  
<sup>f</sup> Fast-Cure Urethane/Dam/Primer - Quantity 2

**Avalanche 4 Door Crew Cab ..... 2006**

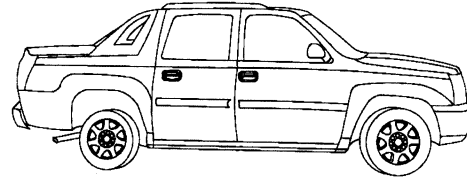

|   |                  |
|---|------------------|
| <b>DW01736<sup>a,c,d</sup></b> Windshield (Solar) (W/Third Visor Frit, Aftermarket, Solar Coated) ..... | <b>31.5x69.1</b> |
| <b>DW01549<sup>b,c,d</sup></b> Windshield (Solar) (W/Third Visor Frit) .....                            | <b>31.5x69.1</b> |
| <b>DD09479-80</b> Door F/R-L (Solar) .....  | <b>26.4x32.4</b> |
| <b>DD09734-35</b> Door R/R-L (Solar) .....  | <b>26.1x30.1</b> |
| <b>DR11694</b> Roof (Solar) .....   |                  |
| <b>DB10062</b> Back Window (Encap)(Heated)(Solar) .....   | <b>12.0x51.0</b> |

<sup>a</sup> Not On Production Vehicles  
<sup>b</sup> On Production Vehicles  
<sup>c</sup> Urethane,Dam,Primer - 2 Tubes  
<sup>d</sup> Fast-Cure Urethane/Dam/Primer - Quantity 2

**Aveo 4 Door Hatchback..... 2006-2008**

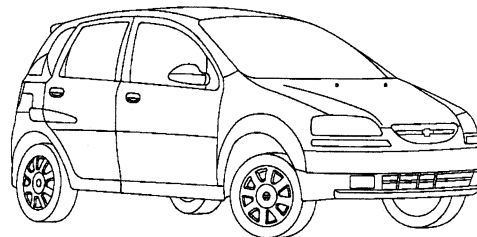

|  |                  |
|--|------------------|
| <b>DW01561<sup>a,b</sup></b> Windshield .....                            | <b>36.9x53.8</b> |
| <b>DD10639-40</b> Door F/R-L .....                                       | <b>21.8x38.0</b> |
| <b>DD10644-45</b> Door R/R-L .....                                       | <b>19.0x24.5</b> |
| <b>DR10866</b> Roof (Solar) .....  | <b>15.0x31.5</b> |
| <b>DQ10646-47<sup>d</sup></b> Quarter R-L .....                          | <b>9.0x14.5</b>  |
| <b>DB10648<sup>c</sup></b> Back Window (Heated)(1 Holes) (W/Wiper) ..... | <b>19.0x54.5</b> |

<sup>a</sup> Urethane,Dam,Primer - 2 Tubes  
<sup>b</sup> Fast-Cure Urethane/Dam/Primer - Quantity 2  
<sup>c</sup> Urethane,Dam,Primer - 1.5 Tubes  
<sup>d</sup> Urethane,Dam,Primer - 1 Tube

**Aveo 4 Door Sedan..... 2007-2011**

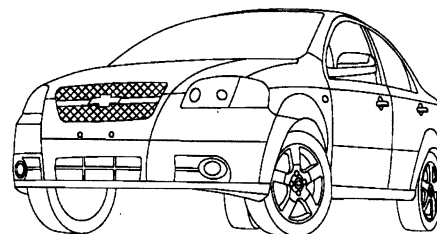

|   |                  |
|---|------------------|
| <b>DW01695<sup>a,b</sup></b> Windshield ..... | <b>36.2x53.8</b> |
| <b>DD10639-40</b> Door F/R-L .....            | <b>21.8x38.0</b> |

**Chevrolet**

**Astra 4 Door Hatchback (MEXICO Only) ..... 2006-2009**

|   |                  |
|---|------------------|
| <b>DW01675<sup>a,b,d</sup></b> Windshield (Encap)(Solar) (Mexico Only, Solar Coated, Rain Sensor) ..... | <b>35.0x55.0</b> |
| <b>DW01674<sup>a,b</sup></b> Windshield (Encap) (Rain Sensor) .....                                     | <b>35.0x55.0</b> |
| <b>DW01673<sup>a,b</sup></b> Windshield (Encap) (Mexico Only) .....                                     | <b>35.0x55.0</b> |
| <b>DD11243-44</b> Door F/R-L .....  | <b>19.3x37.0</b> |
| <b>DD11245-46</b> Door R/R-L .....  | <b>21.3x26.0</b> |
| <b>DV11247-48</b> Vent R/R-L .....  | <b>10.0x12.5</b> |
| <b>DB11249<sup>c</sup></b> Back Window (Encap)(Heated) .....  | <b>18.5x57.0</b> |

<sup>a</sup> Urethane,Dam,Primer - 2 Tubes  
<sup>b</sup> Fast-Cure Urethane/Dam/Primer - Quantity 2  
<sup>c</sup> Urethane,Dam,Primer - 1.5 Tubes  
<sup>d</sup> Rain Sensor Kit

**Astra 4 Door Sedan (MEXICO Only) ..... 2006**

|   |                  |
|---|------------------|
| <b>DW01443<sup>a,b</sup></b> Windshield (Mexico Only) .....         | <b>34.0x53.5</b> |
| <b>DD09951-52</b> Door F/R-L (Mexico Only) .....                    | <b>18.0x30.5</b> |
| <b>DD09953-54</b> Door R/R-L (Mexico Only) .....                    | <b>18.3x24.5</b> |
| <b>DV09955-56</b> Vent R/R-L (Mexico Only) .....                    | <b>6.7x13.0</b>  |
| <b>DB09957<sup>c</sup></b> Back Window (Heated) (Mexico Only) ..... | <b>25.5x44.0</b> |

<sup>a</sup> Urethane,Dam,Primer - 2 Tubes  
<sup>b</sup> Fast-Cure Urethane/Dam/Primer - Quantity 2  
<sup>c</sup> Urethane,Dam,Primer - 1.5 Tubes

**Avalanche 4 Door Crew Cab..... 2007-2011**

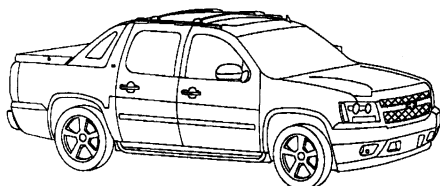

|   |                  |
|---|------------------|
| <b>DW01883<sup>b,e,f</sup></b> Windshield (Solar) (W/Third Visor Frit, Acoustic Inter-layer) (11) ..... | <b>31.0x67.0</b> |
| <b>DW01659<sup>a,e,f</sup></b> Windshield (Solar) (W/Third Visor Frit, Rain Sensor) .....               | <b>33.5x67.8</b> |
| <b>DW01658<sup>c,d,e,f</sup></b> Windshield (Solar) (W/Third Visor Frit) .....                          | <b>33.5x67.8</b> |
| <b>DD11163-64</b> Door F/R-L (Solar) .....  | <b>26.8x32.5</b> |
| <b>DD11169-70</b> Door R/R-L (Solar) .....  | <b>27.3x30.0</b> |
| <b>DB10062</b> Back Window (Encap)(Heated)(Solar) .....   | <b>12.0x51.0</b> |

<sup>a</sup> May Require Replacement of Rain Sensor  
<sup>b</sup> On Production Vehicles

| <i>Aveo</i>   | <i>(cont.)</i>                   |           |
|---|----------------------------------|-----------|
| DD11286-87  | Door R/R-L (2 Holes)             | 21.0x28.0 |
| DR10866   | Roof (Solar)                     | 15.0x31.5 |
| DB11288 <sup>c</sup>                                    | Back Window (Ant)(Heated)(Solar) | 27.0x47.5 |
| <sup>a</sup> Urethane,Dam,Primer - 2 Tubes              |                                  |           |
| <sup>b</sup> Fast-Cure Urethane/Dam/Primer - Quantity 2 |                                  |           |
| <sup>c</sup> Urethane,Dam,Primer - 1.5 Tubes            |                                  |           |

**Aveo 4 Door Sedan ..... 2006**

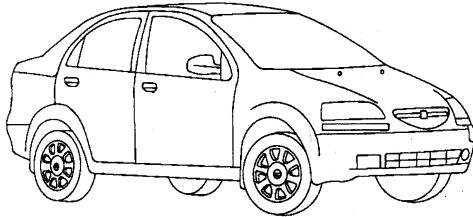

|   |                      |           |
|---|----------------------|-----------|
| DW01561 <sup>a b</sup>                                  | Windshield           | 36.9x53.8 |
| DD10639-40  | Door F/R-L           | 21.8x38.0 |
| DD10641-42  | Door R/R-L           | 21.3x27.3 |
| DR10866   | Roof (Solar)         | 15.0x31.5 |
| DB10643 <sup>c</sup>                                    | Back Window (Heated) | 25.0x46.0 |
| <sup>a</sup> Urethane,Dam,Primer - 2 Tubes              |                      |           |
| <sup>b</sup> Fast-Cure Urethane/Dam/Primer - Quantity 2 |                      |           |
| <sup>c</sup> Urethane,Dam,Primer - 1.5 Tubes            |                      |           |

**Aveo5 4 Door Hatchback ..... 2009-2011**

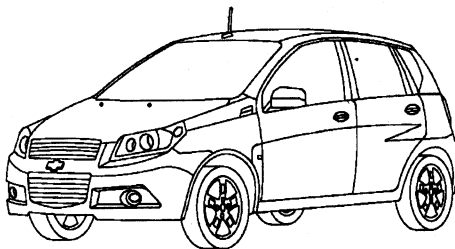

|   |                                |           |
|---|--------------------------------|-----------|
| DW01695 <sup>a b</sup>                                  | Windshield                     | 36.2x53.8 |
| DD10639-40  | Door F/R-L                     | 21.8x38.0 |
| DD11780-81  | Door R/R-L                     | 19.0x24.5 |
| DR10866   | Roof (Solar)                   | 15.0x31.5 |
| DQ10646-47 <sup>d</sup>                                 | Quarter R-L                    | 9.0x14.5  |
| DB11706 <sup>c</sup>                                    | Back Window (Heated) (W/Wiper) | 18.5x52.5 |
| <sup>a</sup> Urethane,Dam,Primer - 2 Tubes              |                                |           |
| <sup>b</sup> Fast-Cure Urethane/Dam/Primer - Quantity 2 |                                |           |
| <sup>c</sup> Urethane,Dam,Primer - 1.5 Tubes            |                                |           |
| <sup>d</sup> Urethane,Dam,Primer - 1 Tube               |                                |           |

**Camaro 2 Door Coupe ..... 2010-2011**

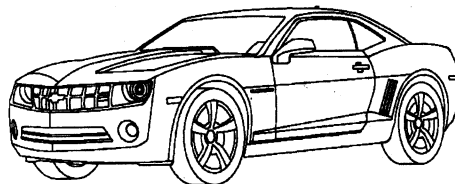

|                        |  |           |
|------------------------|--|-----------|
| DW01878 <sup>a b</sup> | Windshield (HUD)(Solar) (W/Third Visor Frit, W/Remote Start) | 32.6x61.5 |
| DW01877 <sup>a b</sup> | Windshield (HUD)(Solar) (W/Third Visor Frit)                 | 32.6x61.5 |

| <i>Camaro</i>   | <i>(cont.)</i>  |           |
|---|---|-----------|
| DW01814 <sup>a b</sup>                                  | Windshield (Solar) (W/Third Visor Frit, W/Remote Start) | 32.6x61.5 |
| DW01813 <sup>a b</sup>                                  | Windshield (Solar) (W/Third Visor Frit)                 | 32.6x61.5 |
| DD11716-17  | Door F/R-L (Solar)                                      | 14.0x39.5 |
| DQ11718-19 <sup>d</sup>                                 | Quarter R-L (Encap)(Solar)                              | 11.0x17.0 |
| DB11720 <sup>c</sup>                                    | Back Window (Ant)(Heated)(Solar)                        | 30.0x42.2 |
| <sup>a</sup> Urethane,Dam,Primer - 2 Tubes              |   |           |
| <sup>b</sup> Fast-Cure Urethane/Dam/Primer - Quantity 2 |   |           |
| <sup>c</sup> Urethane,Dam,Primer - 1.5 Tubes            |   |           |
| <sup>d</sup> Urethane,Dam,Primer - 1 Tube               |   |           |

**Captiva Sport 4 Door Utility (MEXICO Only) ... 2008-2010**

|   |  |           |
|---|--|-----------|
| DW01762 <sup>a b c</sup>                                | Windshield (Solar) (W/Third Visor Frit, Rain Sensor) (From 09/2007)    | 38.5x56.5 |
| DW01761 <sup>a b c</sup>                                | Windshield (Solar) (W/Third Visor Frit) (From 09/2007)                 | 38.5x56.5 |
| DW01738 <sup>a b c</sup>                                | Windshield (Solar) (W/Third Visor Frit, Rain Sensor) (To 09/2007) (08) | 38.5x56.5 |
| DW01737 <sup>a b c</sup>                                | Windshield (Solar) (W/Third Visor Frit) (To 09/2007) (08)              | 38.5x56.5 |
| DD11498-99  | Door F/R-L (2 Holes)(Solar)  | 27.3x37.0 |
| DD11500-01  | Door R/R-L (2 Holes)(Solar)  | 23.5x29.5 |
| DQ11502-03 <sup>e</sup>                                 | Quarter R-L (Encap)(Solar)   | 17.0x22.0 |
| DB11504 <sup>d</sup>                                    | Back Window (Heated)(1 Holes)(Solar) (W/Wiper)                         | 27.0x51.0 |
| <sup>a</sup> May Require Two Person Installation        |  |           |
| <sup>b</sup> Urethane,Dam,Primer - 2 Tubes              |  |           |
| <sup>c</sup> Fast-Cure Urethane/Dam/Primer - Quantity 2 |  |           |
| <sup>d</sup> Urethane,Dam,Primer - 1.5 Tubes            |  |           |
| <sup>e</sup> Urethane,Dam,Primer - 1 Tube               |  |           |

**Chevy 2 Door Hatchback (MEXICO Only) ..... 2006-2011**

|   |  |           |
|---|--|-----------|
| FW00779 <sup>a b</sup>                                    | Windshield (Mexico Only)   | 33.7x46.9 |
| FD05336-37  | Door F/R-L (Mexico Only)   | 20.4x38.3 |
| FQ05338-39 <sup>c</sup>                                   | Quarter R-L (Mexico Only)  | 19.5x31.3 |
| FB24145 <sup>a</sup>                                      | Back Window (Heated) (Mexico Only, High Mount Brake Light) (08-11) | 24.4x50.0 |
| FB05340 <sup>a</sup>                                      | Back Window (Heated) (Mexico Only) (06-07)                         | 24.4x50.0 |
| <sup>a</sup> Urethane,Dam,Primer - 1.5 Tubes              |  |           |
| <sup>b</sup> Fast-Cure Urethane/Dam/Primer - Quantity 1.5 |  |           |
| <sup>c</sup> Urethane,Dam,Primer - 1 Tube                 |  |           |

**Chevy 4 Door Hatchback (MEXICO Only) ..... 2006-2010**

|   |  |           |
|---|--|-----------|
| FW00779 <sup>a b</sup>                                    | Windshield (Mexico Only)   | 33.7x46.9 |
| FD05341-42  | Door F/R-L   | 20.0x33.7 |
| FD05343-44  | Door R/R-L   | 19.3x30.0 |
| FQ05345-46 <sup>c</sup>                                   | Quarter R-L  | 16.0x18.2 |
| FB24842 <sup>a</sup>                                      | Back Window (Mexico Only) (08-10)                                  |           |
| FB24146 <sup>a</sup>                                      | Back Window (Heated) (Mexico Only, High Mount Brake Light) (08-10) | 20.0x49.0 |
| FB05347 <sup>a</sup>                                      | Back Window (Heated) (06-07)                                       | 20.0x49.0 |
| <sup>a</sup> Urethane,Dam,Primer - 1.5 Tubes              |  |           |
| <sup>b</sup> Fast-Cure Urethane/Dam/Primer - Quantity 1.5 |  |           |
| <sup>c</sup> Urethane,Dam,Primer - 1 Tube                 |  |           |

**Chevy 4 Door Sedan (MEXICO Only) ..... 2006-2011**

|                           |   |           |
|---------------------------|---|-----------|
| FW02133 <sup>a b</sup>    | Windshield (Mexico Only)                                      | 32.0x52.0 |
| FD20754-55                | Door F/R-L (Mexico Only)                                      | 17.5x28.5 |
| FD20756-57                | Door R/R-L (Mexico Only)                                      | 17.0x26.0 |
| FQ20758-59 <sup>d e</sup> | Quarter R-L (Encap) (Paint Band, Mexico Only)                 | 8.0x15.0  |
| FB24351 <sup>c</sup>      | Back Window (Paint Band, Mexico Only, High Mount Brake Light) | 23.0x47.0 |

**Chevy (cont.)**

- FB24350<sup>c</sup> Back Window (Paint Band, Mexico Only) ..... 23.0x47.0
- FB20760<sup>c</sup> Back Window (Heated) (Paint Band, Mexico Only) .... 23.0x47.0
- <sup>a</sup> Urethane,Dam,Primer - 2 Tubes
- <sup>b</sup> Fast-Cure Urethane/Dam/Primer - Quantity 2
- <sup>c</sup> Urethane,Dam,Primer - 1.5 Tubes
- <sup>d</sup> Urethane,Dam,Primer - 1 Tube
- <sup>e</sup> Encapsulation Lubricant

**Cheyenne 2 Door Extended Cab (MEXICO Only) 2009-2011**

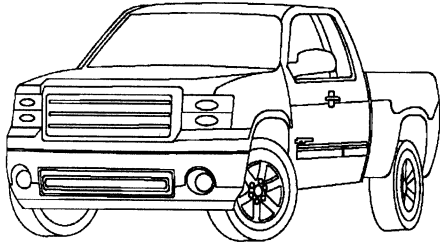

- DW01883<sup>a f g</sup> Windshield (Solar) (W/Third Visor Frit, Acoustic Inter-layer) (11) ..... 31.0x67.0
- DW01658<sup>b c f g</sup> Windshield (Solar) (W/Third Visor Frit) ..... 33.5x67.8
- DD11163-64 Door F/R-L (Solar) ..... 26.8x32.5
- DQ11174-75 Quarter R-L (Solar) (Movable) ..... 18.0x22.0
- DB11388 Back Window C (Slider)(Solar) (OE, Power) ..... 13.0x16.0
- DB11386 Back Window C (Slider)(Solar) (OE, Manual) ..... 13.0x16.0
- DY90115<sup>f</sup> Back Window (Slider)(Solar) (Aftermarket, 1 Panel Flush Fit, Manual) ..... 17.5x64.3
- DY90097<sup>f</sup> Back Window (Encap)(Slider)(Solar) (Aftermarket, Power, Curved, 3 Panel Encapsulated) ..... 18.1x64.8
- DY90096<sup>f</sup> Back Window (Encap)(Slider) (Aftermarket, Curved, Manual, 3 Panel Encapsulated) ..... 18.1x64.8
- DY90095<sup>f</sup> Back Window (Encap)(Slider)(Solar) (Aftermarket, Curved, Manual, 3 Panel Encapsulated) ..... 18.1x64.8
- DY90092<sup>f</sup> Back Window (Encap)(Slider) (Black Frame, Aftermarket, Manual, 3 Panel Encapsulated) ..... 18.1x64.8
- DY90091<sup>f</sup> Back Window (Encap)(Slider)(Solar) (Black Frame, Aftermarket, Manual, 3 Panel Encapsulated) ..... 18.1x64.8
- DY90090<sup>f</sup> Back Window (Encap)(Slider)(Solar) (Black Frame, Aftermarket, Power, 3 Panel Encapsulated) ..... 18.1x64.8
- DB11915<sup>e f</sup> Back Window (Slider)(Solar) (OE, Power) (11) ..... 17.5x64.3
- DB11914<sup>d f</sup> Back Window (Slider)(Solar) (Manual) (11) ..... 17.5x64.3
- DB11387<sup>f</sup> Back Window (Slider)(Solar) (OE, Power) (09-10) ..... 17.5x64.3
- DB11178<sup>f</sup> Back Window (Slider)(Solar) (Manual) (09-10) ..... 17.5x64.3
- DB11177<sup>f</sup> Back Window (Heated)(Solar) (Stationary) ..... 17.5x64.3
- DB11176<sup>f</sup> Back Window (Solar) (Stationary) ..... 17.5x64.3

- <sup>a</sup> On Production Vehicles
- <sup>b</sup> Not On Production Vehicles 2011 Up
- <sup>c</sup> On Production Vehicles 2007-2010
- <sup>d</sup> Lower Corners Changed From DB11178
- <sup>e</sup> Lower Corners Changed From DB11387
- <sup>f</sup> Urethane,Dam,Primer - 2 Tubes
- <sup>g</sup> Fast-Cure Urethane/Dam/Primer - Quantity 2

**Cheyenne 2 Door Standard Cab (MEXICO Only) 2009-2011**

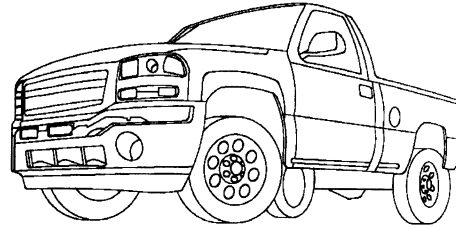

- DW01883<sup>a e f</sup> Windshield (Solar) (W/Third Visor Frit, Acoustic Inter-layer) (11) ..... 31.0x67.0
- DW01658<sup>b c e f</sup> Windshield (Solar) (W/Third Visor Frit) ..... 33.5x67.8
- DD11163-64 Door F/R-L (Solar) ..... 26.8x32.5
- DB11386 Back Window C (Slider)(Solar) (OE, Manual) ..... 13.0x16.0
- DY90115<sup>e</sup> Back Window (Slider)(Solar) (Aftermarket, 1 Panel Flush Fit, Manual) ..... 17.5x64.3
- DY90097<sup>e</sup> Back Window (Encap)(Slider)(Solar) (Aftermarket, Power, Curved, 3 Panel Encapsulated) ..... 18.1x64.8
- DY90096<sup>e</sup> Back Window (Encap)(Slider) (Aftermarket, Curved, Manual, 3 Panel Encapsulated) ..... 18.1x64.8
- DY90095<sup>e</sup> Back Window (Encap)(Slider)(Solar) (Aftermarket, Curved, Manual, 3 Panel Encapsulated) ..... 18.1x64.8
- DY90092<sup>e</sup> Back Window (Encap)(Slider) (Black Frame, Aftermarket, Manual, 3 Panel Encapsulated) ..... 18.1x64.8
- DY90091<sup>e</sup> Back Window (Encap)(Slider)(Solar) (Black Frame, Aftermarket, Manual, 3 Panel Encapsulated) ..... 18.1x64.8
- DY90090<sup>e</sup> Back Window (Encap)(Slider)(Solar) (Black Frame, Aftermarket, Power, 3 Panel Encapsulated) ..... 18.1x64.8
- DB11914<sup>d e</sup> Back Window (Slider)(Solar) (Manual) (11) ..... 17.5x64.3
- DB11178<sup>e</sup> Back Window (Slider)(Solar) (Manual) (09-10) ..... 17.5x64.3
- DB11177<sup>e</sup> Back Window (Heated)(Solar) (Stationary) ..... 17.5x64.3
- DB11176<sup>e</sup> Back Window (Solar) (Stationary) ..... 17.5x64.3

- <sup>a</sup> On Production Vehicles
- <sup>b</sup> Not On Production Vehicles 2011 Up
- <sup>c</sup> On Production Vehicles 2007-2010
- <sup>d</sup> Lower Corners Changed From DB11178
- <sup>e</sup> Urethane,Dam,Primer - 2 Tubes
- <sup>f</sup> Fast-Cure Urethane/Dam/Primer - Quantity 2

**Cheyenne 4 Door Crew Cab (MEXICO Only)..... 2009-2011**

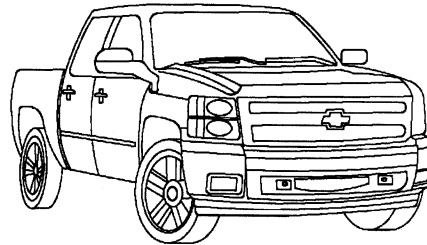

- DW01883<sup>b g h</sup> Windshield (Solar) (W/Third Visor Frit, Acoustic Inter-layer) (11) ..... 31.0x67.0
- DW01659<sup>a g h</sup> Windshield (Solar) (W/Third Visor Frit, Rain Sensor) ..... 33.5x67.8
- DW01658<sup>c d g h</sup> Windshield (Solar) (W/Third Visor Frit) ..... 33.5x67.8
- DD11163-64 Door F/R-L (Solar) ..... 26.8x32.5
- DD11169-70 Door R/R-L (Solar) ..... 27.3x30.0
- DB11388 Back Window C (Slider)(Solar) (OE, Power) ..... 13.0x16.0
- DB11386 Back Window C (Slider)(Solar) (OE, Manual) ..... 13.0x16.0
- DY90115<sup>e</sup> Back Window (Slider)(Solar) (Aftermarket, 1 Panel Flush Fit, Manual) ..... 17.5x64.3
- DY90097<sup>e</sup> Back Window (Encap)(Slider)(Solar) (Aftermarket, Power, Curved, 3 Panel Encapsulated) ..... 18.1x64.8
- DY90096<sup>e</sup> Back Window (Encap)(Slider) (Aftermarket, Curved, Manual, 3 Panel Encapsulated) ..... 18.1x64.8

**Cheyenne (cont.)**

|                        |   |           |
|------------------------|---|-----------|
| DY90095 <sup>g</sup>   | Back Window (Encap)(Slider)(Solar) (Aftermarket, Curved, Manual, 3 Panel Encapsulated) .....      | 18.1x64.8 |
| DY90092 <sup>g</sup>   | Back Window (Encap)(Slider) (Black Frame, Aftermarket, Manual, 3 Panel Encapsulated) .....        | 18.1x64.8 |
| DY90091 <sup>g</sup>   | Back Window (Encap)(Slider)(Solar) (Black Frame, Aftermarket, Manual, 3 Panel Encapsulated) ..... | 18.1x64.8 |
| DY90090 <sup>g</sup>   | Back Window (Encap)(Slider)(Solar) (Black Frame, Aftermarket, Power, 3 Panel Encapsulated) .....  | 18.1x64.8 |
| DB11915 <sup>f,g</sup> | Back Window (Slider)(Solar) (OE, Power) (11) .....  | 17.5x64.3 |
| DB11914 <sup>e,g</sup> | Back Window (Slider)(Solar) (Manual) (11) .....   | 17.5x64.3 |
| DB11387 <sup>g</sup>   | Back Window (Slider)(Solar) (OE, Power) (09-10) .....   | 17.5x64.3 |
| DB11178 <sup>g</sup>   | Back Window (Slider)(Solar) (Manual) (09-10) .....  | 17.5x64.3 |
| DB11177 <sup>g</sup>   | Back Window (Heated)(Solar) (Stationary) .....  | 17.5x64.3 |
| DB11176 <sup>g</sup>   | Back Window (Solar) (Stationary) .....  | 17.5x64.3 |

<sup>a</sup> May Require Replacement of Rain Sensor  
<sup>b</sup> On Production Vehicles  
<sup>c</sup> Not On Production Vehicles 2011 Up  
<sup>d</sup> On Production Vehicles 2007-2010  
<sup>e</sup> Lower Corners Changed From DB11178  
<sup>f</sup> Lower Corners Changed From DB11387  
<sup>g</sup> Urethane,Dam,Primer - 2 Tubes  
<sup>h</sup> Fast-Cure Urethane/Dam/Primer - Quantity 2

**Cobalt 2 Door Coupe..... 2006-2011**

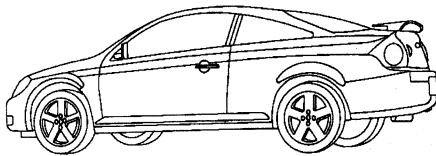

|                         |   |           |
|-------------------------|---|-----------|
| DW01605 <sup>a,b</sup>  | Windshield (Solar) (W/Third Visor Frit) ..... | 35.8x55.7 |
| DD10870-71              | Door F/R-L (Solar) .....                      | 22.8x46.3 |
| DQ10872-73 <sup>c</sup> | Quarter R-L (Encap)(Solar) .....              | 11.5x28.0 |
| DB10874 <sup>a</sup>    | Back Window (Encap)(Heated)(Solar) .....      | 37.5x55.0 |

<sup>a</sup> Urethane,Dam,Primer - 2 Tubes  
<sup>b</sup> Fast-Cure Urethane/Dam/Primer - Quantity 2  
<sup>c</sup> Urethane,Dam,Primer - 1 Tube

**Cobalt 4 Door Sedan..... 2006-2011**

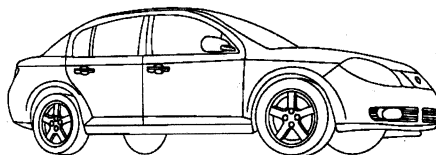

|                        |   |           |
|------------------------|---|-----------|
| DW01606 <sup>a,b</sup> | Windshield (Solar) (W/Third Visor Frit) ..... | 36.9x56.0 |
| DD10875-76             | Door F/R-L (2 Holes)(Solar) .....             | 22.0x35.0 |
| DD10877-78             | Door R/R-L (Solar) .....                      | 21.0x26.0 |
| DV10879-80             | Vent R/R-L (Solar) .....                      | 9.5x13.0  |
| DB10881 <sup>c</sup>   | Back Window (Encap)(Heated)(Solar) .....      | 29.0x47.0 |

<sup>a</sup> Urethane,Dam,Primer - 2 Tubes  
<sup>b</sup> Fast-Cure Urethane/Dam/Primer - Quantity 2  
<sup>c</sup> Urethane,Dam,Primer - 1.5 Tubes

**Colorado 2 Door Extended Cab ..... 2006-2011**

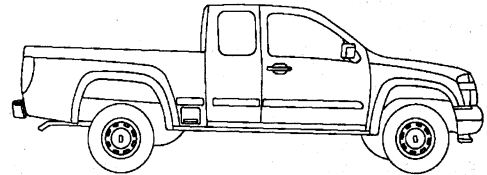

|                         |   |           |
|-------------------------|---|-----------|
| DW01533 <sup>a,b</sup>  | Windshield .....  | 32.0x57.4 |
| DD10498-99              | Door F/R-L .....  | 21.0x34.0 |
| DQ10503-04 <sup>d</sup> | Quarter R-L (Solar) .....   | 15.3x18.8 |
| DY90108 <sup>c</sup>    | Back Window (Encap)(Slider)(Solar) (Black Frame, Aftermarket, Power, 3 Panel Encapsulated) .....  | 13.7x54.0 |
| DY90107 <sup>c</sup>    | Back Window (Encap)(Slider)(Solar) (Black Frame, Aftermarket, Manual, 3 Panel Encapsulated) ..... | 13.7x54.0 |
| DB10507 <sup>c</sup>    | Back Window (Encap)(Slider)(Solar) (OE) .....   | 13.7x54.0 |
| DB10500 <sup>c</sup>    | Back Window (Solar) (Stationary) .....  | 13.7x54.0 |

<sup>a</sup> Urethane,Dam,Primer - 2 Tubes  
<sup>b</sup> Fast-Cure Urethane/Dam/Primer - Quantity 2  
<sup>c</sup> Urethane,Dam,Primer - 1.5 Tubes  
<sup>d</sup> Urethane,Dam,Primer - 1 Tube

**Colorado 2 Door Standard Cab ..... 2006-2011**

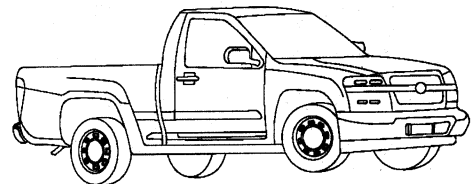

|                        |   |           |
|------------------------|---|-----------|
| DW01533 <sup>a,b</sup> | Windshield .....  | 32.0x57.4 |
| DD10498-99             | Door F/R-L .....  | 21.0x34.0 |
| DY90108 <sup>c</sup>   | Back Window (Encap)(Slider)(Solar) (Black Frame, Aftermarket, Power, 3 Panel Encapsulated) .....  | 13.7x54.0 |
| DY90107 <sup>c</sup>   | Back Window (Encap)(Slider)(Solar) (Black Frame, Aftermarket, Manual, 3 Panel Encapsulated) ..... | 13.7x54.0 |
| DB10507 <sup>c</sup>   | Back Window (Encap)(Slider)(Solar) (OE) .....   | 13.7x54.0 |
| DB10500 <sup>c</sup>   | Back Window (Solar) (Stationary) .....  | 13.7x54.0 |

<sup>a</sup> Urethane,Dam,Primer - 2 Tubes  
<sup>b</sup> Fast-Cure Urethane/Dam/Primer - Quantity 2  
<sup>c</sup> Urethane,Dam,Primer - 1.5 Tubes

**Colorado 4 Door Crew Cab ..... 2006-2011**

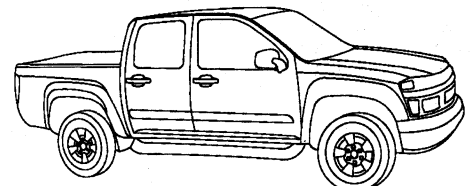

|                        |   |           |
|------------------------|---|-----------|
| DW01533 <sup>a,b</sup> | Windshield .....  | 32.0x57.4 |
| DD10498-99             | Door F/R-L .....  | 21.0x34.0 |
| DD10505-06             | Door R/R-L (Solar) .....  | 21.0x24.0 |
| DY90108 <sup>c</sup>   | Back Window (Encap)(Slider)(Solar) (Black Frame, Aftermarket, Power, 3 Panel Encapsulated) .....  | 13.7x54.0 |
| DY90107 <sup>c</sup>   | Back Window (Encap)(Slider)(Solar) (Black Frame, Aftermarket, Manual, 3 Panel Encapsulated) ..... | 13.7x54.0 |
| DB10507 <sup>c</sup>   | Back Window (Encap)(Slider)(Solar) (OE) .....   | 13.7x54.0 |
| DB10500 <sup>c</sup>   | Back Window (Solar) (Stationary) .....  | 13.7x54.0 |

**Colorado (cont.)**

<sup>a</sup> Urethane,Dam,Primer - 2 Tubes  
<sup>b</sup> Fast-Cure Urethane/Dam/Primer - Quantity 2  
<sup>c</sup> Urethane,Dam,Primer - 1.5 Tubes

**Corsa 4 Door Hatchback (MEXICO Only) ..... 2006-2008**

|                         |   |           |
|-------------------------|---|-----------|
| DW01502 <sup>a,b</sup>  | Windshield (Solar) (Mexico Only) .....                      | 34.0x50.0 |
| DD10288-89              | Door F/R-L (Mexico Only) .....                              | 22.0x30.5 |
| DD10290-91              | Door R/R-L (Mexico Only) .....                              | 22.0x28.0 |
| DQ11195-96 <sup>d</sup> | Quarter R-L (Encap) (Mexico Only) .....                     | 9.0x15.0  |
| DB11199 <sup>c</sup>    | Back Window (Heated)(1 Holes) (Mexico Only, W/ Wiper) ..... |           |
| DB11198 <sup>c</sup>    | Back Window (Heated) (Mexico Only) .....                    |           |
| DB11197 <sup>c</sup>    | Back Window (Mexico Only) .....                             |           |

<sup>a</sup> Urethane,Dam,Primer - 2 Tubes  
<sup>b</sup> Fast-Cure Urethane/Dam/Primer - Quantity 2  
<sup>c</sup> Urethane,Dam,Primer - 1.5 Tubes  
<sup>d</sup> Urethane,Dam,Primer - 1 Tube

**Corsa 4 Door Sedan (MEXICO Only)..... 2006-2008**

|                        |   |           |
|------------------------|---|-----------|
| DW01502 <sup>a,b</sup> | Windshield (Solar) (Mexico Only) .....                      | 34.0x50.0 |
| DD10288-89             | Door F/R-L (Mexico Only) .....                              | 22.0x30.5 |
| DD10290-91             | Door R/R-L (Mexico Only) .....                              | 22.0x28.0 |
| DQ10292-93             | Quarter R-L (Encap) (Mexico Only) .....                     | 11.0x14.5 |
| DB10588 <sup>c</sup>   | Back Window (Heated)(1 Holes) (Mexico Only, W/ Wiper) ..... | 23.0x47.0 |
| DB10294 <sup>c</sup>   | Back Window (Heated) (Mexico Only) .....                    | 23.0x47.0 |

<sup>a</sup> Urethane,Dam,Primer - 2 Tubes  
<sup>b</sup> Fast-Cure Urethane/Dam/Primer - Quantity 2  
<sup>c</sup> Urethane,Dam,Primer - 1.5 Tubes

**Corvette 2 Door Convertible..... 2006-2011**

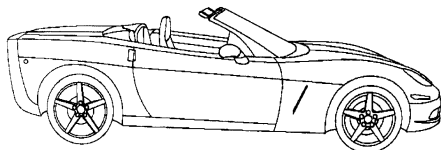

|                        |   |           |
|------------------------|---|-----------|
| DW01804 <sup>a,b</sup> | Windshield (HUD)(Solar) (W/GPS) (09-11) ..... | 39.4x61.4 |
| DW01803 <sup>a,b</sup> | Windshield (HUD)(Solar) (09-11) .....         | 39.4x61.4 |
| DW01802 <sup>a,b</sup> | Windshield (Solar) (W/GPS) (09-11) .....      | 39.4x61.4 |
| DW01801 <sup>a,b</sup> | Windshield (Solar) (09-11) .....              | 39.4x61.4 |
| DW01589 <sup>a,b</sup> | Windshield (HUD)(Solar) (W/GPS) (06-08) ..... | 39.4x61.4 |
| DW01588 <sup>a,b</sup> | Windshield (HUD)(Solar) (06-08) .....         | 39.4x61.4 |
| DW01587 <sup>a,b</sup> | Windshield (Solar) (06-08) .....              | 39.4x61.4 |
| DD10798-99             | Door F/R-L .....                              | 15.0x40.0 |

<sup>a</sup> Urethane,Dam,Primer - 2 Tubes  
<sup>b</sup> Fast-Cure Urethane/Dam/Primer - Quantity 2

**Corvette 2 Door Coupe ..... 2006-2011**

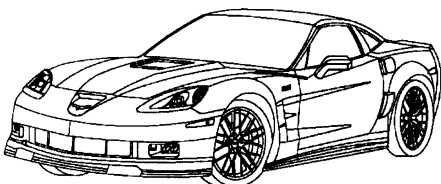

|                        |   |           |
|------------------------|---|-----------|
| DW01804 <sup>a,b</sup> | Windshield (HUD)(Solar) (W/GPS) (09-11) ..... | 39.4x61.4 |
|------------------------|---|-----------|

**Corvette (cont.)**

|                        |   |           |
|------------------------|---|-----------|
| DW01803 <sup>a,b</sup> | Windshield (HUD)(Solar) (09-11) .....         | 39.4x61.4 |
| DW01802 <sup>a,b</sup> | Windshield (Solar) (W/GPS) (09-11) .....      | 39.4x61.4 |
| DW01801 <sup>a,b</sup> | Windshield (Solar) (09-11) .....              | 39.4x61.4 |
| DW01589 <sup>a,b</sup> | Windshield (HUD)(Solar) (W/GPS) (06-08) ..... | 39.4x61.4 |
| DW01588 <sup>a,b</sup> | Windshield (HUD)(Solar) (06-08) .....         | 39.4x61.4 |
| DW01587 <sup>a,b</sup> | Windshield (Solar) (06-08) .....              | 39.4x61.4 |
| DD10798-99             | Door F/R-L .....                              | 15.0x40.0 |
| DB10800 <sup>a</sup>   | Back Window (Ant)(Heated)(Solar) .....        | 39.0x52.0 |

<sup>a</sup> Urethane,Dam,Primer - 2 Tubes  
<sup>b</sup> Fast-Cure Urethane/Dam/Primer - Quantity 2

**Cruze 4 Door Sedan..... 2010-2011**

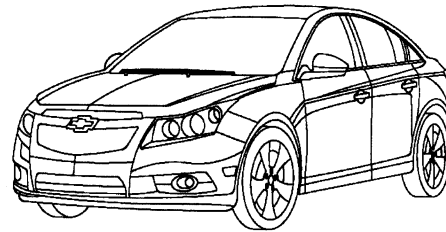

|                        |  |           |
|------------------------|--|-----------|
| DW01835 <sup>a,b</sup> | Windshield (Solar) (W/Third Visor Frit, Rain Sensor) ..... | 37.5x56.5 |
| DW01834 <sup>a,b</sup> | Windshield (Solar) (W/Third Visor Frit) .....              | 37.5x56.5 |
| DD11782-83             | Door F/R-L (Solar) .....                                   | 19.0x30.5 |
| DD11784-85             | Door R/R-L (Solar) .....                                   | 19.0x23.0 |
| DV11786-87             | Vent R/R-L (Solar) .....                                   | 10.5x10.5 |
| DB11788 <sup>c</sup>   | Back Window (Heated)(Solar) .....                          | 28.0x49.0 |

<sup>a</sup> Urethane,Dam,Primer - 2 Tubes  
<sup>b</sup> Fast-Cure Urethane/Dam/Primer - Quantity 2  
<sup>c</sup> Urethane,Dam,Primer - 1.5 Tubes

**Epica 4 Door Sedan ..... 2006-2007 (CANADA Only)**

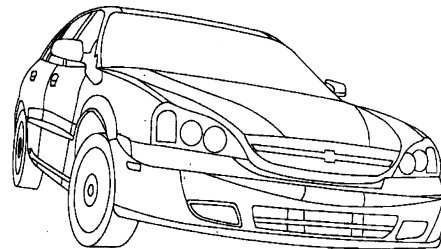

|                        |   |           |
|------------------------|---|-----------|
| FW02578 <sup>a,b</sup> | Windshield (Heated)(Solar) (Heated Wiper Park Area) ..... | 34.0x58.5 |
| FW02445 <sup>a,b</sup> | Windshield (Solar) .....                                  | 34.0x58.5 |
| FW02444 <sup>a,b</sup> | Windshield .....  | 34.0x58.5 |
| FD22175-76             | Door F/R-L (2 Holes)(Solar) .....                         | 20.0x30.0 |
| FD22179-80             | Door R/R-L (2 Holes)(Solar) .....                         | 20.0x27.0 |
| FV22183-84             | Vent R/R-L (Solar) .....                                  | 9.5x12.0  |
| FB22186 <sup>a</sup>   | Back Window (Ant)(Heated)(Solar) .....                    | 31.0x52.0 |

<sup>a</sup> Urethane,Dam,Primer - 2 Tubes  
<sup>b</sup> Fast-Cure Urethane/Dam/Primer - Quantity 2



**Equinox 4 Door Utility..... 2010-2011**

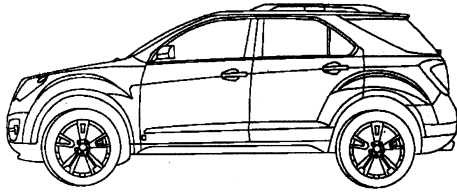

|  |                  |
|--|------------------|
| <b>DW01824<sup>a b</sup></b> Windshield (Solar) (W/Third Visor Frit, Acoustic Inter-layer, W/Remote Start) ..... | <b>36.5x57.0</b> |
| <b>DD11758-59</b> Door F/R-L (Solar) (Laminated) .....   | <b>19.0x30.5</b> |
| <b>DD11760-61</b> Door R/R-L (Solar) .....   | <b>19.0x25.5</b> |
| <b>DQ11764-65<sup>d</sup></b> Quarter R-L (Encap)(Solar) .....   | <b>15.0x33.0</b> |
| <b>DV11762-63</b> Vent R/R-L (Solar) .....   | <b>9.5x10.5</b>  |
| <b>DB11766<sup>c</sup></b> Back Window (Heated)(1 Holes)(Solar) (W/Wiper) ...                                    | <b>21.0x49.0</b> |
| <sup>a</sup> Urethane,Dam,Primer - 2 Tubes   |                  |
| <sup>b</sup> Fast-Cure Urethane/Dam/Primer - Quantity 2  |                  |
| <sup>c</sup> Urethane,Dam,Primer - 1.5 Tubes   |                  |
| <sup>d</sup> Urethane,Dam,Primer - 1 Tube  |                  |

**Equinox 4 Door Utility..... 2006-2009**

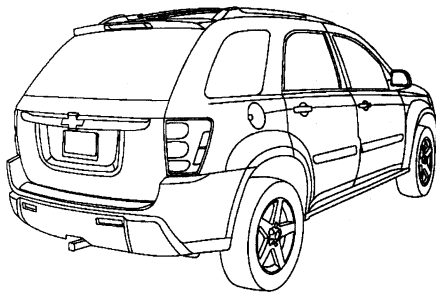

|  |                  |
|--|------------------|
| <b>DW01613<sup>a c d</sup></b> Windshield (Solar) (W/Third Visor Frit, Acoustic Inter-layer) .....   | <b>37.4x51.1</b> |
| <b>DW01583<sup>b c d</sup></b> Windshield (Solar) (W/Third Visor Frit) .....                         | <b>37.4x51.1</b> |
| <b>DD10760-61</b> Door F/R-L (1 Holes)(Solar) .....  | <b>22.7x34.8</b> |
| <b>DD10762-63</b> Door R/R-L (1 Holes)(Solar) .....  | <b>21.2x31.4</b> |
| <b>DR09570</b> Roof (Solar) .....  |                  |
| <b>DQ11489<sup>f</sup></b> Quarter R (Ant)(Encap)(Solar) (W/Remote Start) (To 01/15/2007) (07) ..... | <b>17.3x32.3</b> |
| <b>DQ11478<sup>f</sup></b> Quarter R (Ant)(Solar) (W/Remote Start) (From 01/15/2007) (07-09) .....   | <b>17.3x32.3</b> |
| <b>DQ11476-77<sup>f</sup></b> Quarter R-L (Solar) (From 01/15/2007) (07-09) .....                    | <b>17.3x32.3</b> |
| <b>DQ10764-65<sup>f</sup></b> Quarter R-L (Encap)(Solar) (To 01/15/2007) (06-07) ....                | <b>16.2x32.0</b> |
| <b>DB10766<sup>e</sup></b> Back Window (Heated)(Solar) .....   | <b>25.1x51.1</b> |
| <sup>a</sup> On Production Vehicles  |                  |
| <sup>b</sup> Not On Production Vehicles 2006-09  |                  |
| <sup>c</sup> Urethane,Dam,Primer - 2 Tubes   |                  |
| <sup>d</sup> Fast-Cure Urethane/Dam/Primer - Quantity 2  |                  |
| <sup>e</sup> Urethane,Dam,Primer - 1.5 Tubes   |                  |
| <sup>f</sup> Urethane,Dam,Primer - 1 Tube  |                  |

**Express Extended Van..... 2006-2011**

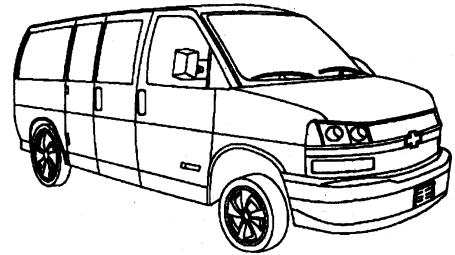

|  |                  |
|--|------------------|
| <b>DW01581<sup>a e f</sup></b> Windshield (Solar) (W/O Bracket, W/Third Visor Frit)  | <b>39.0x73.0</b> |
| <b>DW01580<sup>a e f</sup></b> Windshield (Solar) (W/Third Visor Frit, W/Bracket) ..   | <b>39.0x73.0</b> |
| <b>DD08994-95</b> Door F/R-L (Solar) .....   | <b>26.0x31.6</b> |
| <b>DD10348</b> Door R/L (1 Holes)(Solar) (Rear, Body Side, Movable)  | <b>23.5x28.5</b> |
| <b>DD10347<sup>d</sup></b> Door R/L (Solar) (Stationary, Body Side, Front) .....   | <b>23.5x25.5</b> |
| <b>DD11430<sup>d</sup></b> Door R/R (Solar) (Laminated, Stationary, Sliding Cargo Door, Front) (From 07/01/2007) (07-11) ..... | <b>23.5x25.4</b> |
| <b>DD10355-56<sup>d</sup></b> Door R/R-L (Solar) (Stationary, Hinged Body Side Door, Rear) .....                               | <b>21.4x23.5</b> |
| <b>DD10353-54<sup>d</sup></b> Door R/R-L (Solar) (Stationary, Hinged Body Side Door, Front) .....                              | <b>23.5x25.5</b> |
| <b>DD10351-52</b> Door R/R-L (1 Holes)(Solar) (Hinged Body Side Door, Rear, Movable) .....                                     | <b>21.5x23.5</b> |
| <b>DD10349-50</b> Door R/R-L (1 Holes)(Solar) (Hinged Body Side Door, Movable, Front) .....                                    | <b>23.5x25.5</b> |
| <b>DD10346</b> Door R/R (1 Holes)(Solar) (Rear, Sliding Cargo Door, Movable) .....   | <b>23.5x25.0</b> |
| <b>DD10345<sup>d</sup></b> Door R/R (Solar) (Stationary, Sliding Cargo Door, Front) (To 07/01/2007) (06-07) .....              | <b>23.5x25.4</b> |
| <b>DD10344<sup>c</sup></b> Door R/R (Solar) (Stationary, Sliding Cargo Door) .....   | <b>23.8x50.3</b> |
| <b>DQ11429<sup>b</sup></b> Quarter L (Solar) (Laminated, W/Rear A/C) (From 07/01/2007) (07-11) .....                           | <b>23.7x72.9</b> |
| <b>DQ10370<sup>b</sup></b> Quarter L (Solar) .....   | <b>23.7x72.9</b> |
| <b>DQ10369<sup>b</sup></b> Quarter L (Solar) (W/Rear A/C) (To 07/01/2007) (06-07) .....  | <b>23.7x72.9</b> |
| <b>DQ11428<sup>b</sup></b> Quarter R (Solar) (Laminated) (From 07/01/2007) (07-11) .....                                       | <b>23.7x72.9</b> |
| <b>DQ10368<sup>b</sup></b> Quarter R (Solar) (To 07/01/2007) (06-07) .....   | <b>23.7x72.9</b> |
| <b>DB11383-84</b> Back Window R-L (Heated)(3 Holes)(Solar) (Movable) (08-11) .....   | <b>24.3x27.5</b> |
| <b>DB10363-64</b> Back Window R-L (Heated)(3 Holes)(Solar) (Movable) (06-07) .....   | <b>24.3x27.5</b> |
| <b>DB10361-62</b> Back Window R-L (3 Holes)(Solar) (Movable) .....   | <b>24.3x27.5</b> |
| <b>DB10359-60<sup>d</sup></b> Back Window R-L (Heated)(Solar) (Stationary) .....   | <b>24.3x27.5</b> |
| <b>DB10357-58<sup>d</sup></b> Back Window R-L (Solar) (Stationary) .....   | <b>24.3x27.5</b> |
| <sup>a</sup> May Require Two Person Installation   |                  |
| <sup>b</sup> Urethane,Dam,Primer - 2 Tubes   |                  |
| <sup>c</sup> Urethane,Dam,Primer - 1.5 Tubes   |                  |
| <sup>d</sup> Urethane,Dam,Primer - 1 Tube  |                  |
| <sup>e</sup> Urethane,Dam,Primer - 2.5 Tubes   |                  |
| <sup>f</sup> Fast-Cure Urethane/Dam/Primer - Quantity 2.5  |                  |

**Express Van..... 2006-2011**

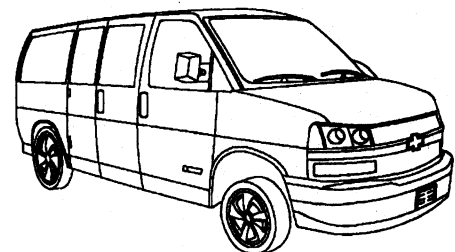

**Express (cont.)**

|  |           |
|--|-----------|
| DW01581 <sup>a d e</sup> Windshield (Solar) (W/O Bracket, W/Third Visor Frit)                                      | 39.0x73.0 |
| DW01580 <sup>a d e</sup> Windshield (Solar) (W/Third Visor Frit, W/Bracket)  | 39.0x73.0 |
| DD08994-95 Door F/R-L (Solar)  | 26.0x31.6 |
| DD10348 Door R/L (1 Holes)(Solar) (Rear, Body Side, Movable)   | 23.5x28.5 |
| DD10347 <sup>c</sup> Door R/L (Solar) (Stationary, Body Side, Front)   | 23.5x25.5 |
| DD11430 <sup>c</sup> Door R/R (Solar) (Laminated, Stationary, Sliding Cargo Door, Front) (From 07/01/2007) (07-11) | 23.5x25.4 |
| DD10355-56 <sup>c</sup> Door R/R-L (Solar) (Stationary, Hinged Body Side Door, Rear)                               | 21.4x23.5 |
| DD10353-54 <sup>c</sup> Door R/R-L (Solar) (Stationary, Hinged Body Side Door, Front)                              | 23.5x25.5 |
| DD10351-52 Door R/R-L (1 Holes)(Solar) (Hinged Body Side Door, Rear, Movable)                                      | 21.5x23.5 |
| DD10349-50 Door R/R-L (1 Holes)(Solar) (Hinged Body Side Door, Movable, Front)                                     | 23.5x25.5 |
| DD10346 Door R/R (1 Holes)(Solar) (Rear, Sliding Cargo Door, Movable)  | 23.5x25.0 |
| DD10345 <sup>c</sup> Door R/R (Solar) (Stationary, Sliding Cargo Door, Front) (To 07/01/2007) (06-07)              | 23.5x25.4 |
| DD10344 <sup>b</sup> Door R/R (Solar) (Stationary, Sliding Cargo Door)   | 23.8x50.3 |
| DQ11427 <sup>b</sup> Quarter L (Solar) (Laminated, W/Rear A/C) (From 07/01/2007) (07-11)                           | 23.5x54.8 |
| DQ10374 <sup>b</sup> Quarter L (Solar) (W/60-40 Side Doors, W/Rear A/C)  | 23.5x54.7 |
| DQ10373 <sup>b</sup> Quarter L (Solar) (W/60-40 Side Doors)  | 23.5x54.7 |
| DQ10367 <sup>b</sup> Quarter L (Solar)   | 23.5x54.8 |
| DQ10366 <sup>b</sup> Quarter L (Solar) (W/Rear A/C) (To 07/01/2007) (06-07)  | 23.5x54.8 |
| DQ11426 <sup>b</sup> Quarter R (Solar) (Laminated) (From 07/01/2007) (07-11)                                       | 23.5x54.8 |
| DQ10365 <sup>b</sup> Quarter R (Solar) (To 07/01/2007) (06-07)   | 23.5x54.8 |
| DB11383-84 Back Window R-L (Heated)(3 Holes)(Solar) (Movable) (08-11)  | 24.3x27.5 |
| DB10363-64 Back Window R-L (Heated)(3 Holes)(Solar) (Movable) (06-07)  | 24.3x27.5 |
| DB10361-62 Back Window R-L (3 Holes)(Solar) (Movable)  | 24.3x27.5 |
| DB10359-60 <sup>c</sup> Back Window R-L (Heated)(Solar) (Stationary)   | 24.3x27.5 |
| DB10357-58 <sup>c</sup> Back Window R-L (Solar) (Stationary)   | 24.3x27.5 |

<sup>a</sup> May Require Two Person Installation  
<sup>b</sup> Urethane,Dam,Primer - 1.5 Tubes  
<sup>c</sup> Urethane,Dam,Primer - 1 Tube  
<sup>d</sup> Urethane,Dam,Primer - 2.5 Tubes  
<sup>e</sup> Fast-Cure Urethane/Dam/Primer - Quantity 2.5

**HHR 4 Door Hatchback ..... 2006-2011**

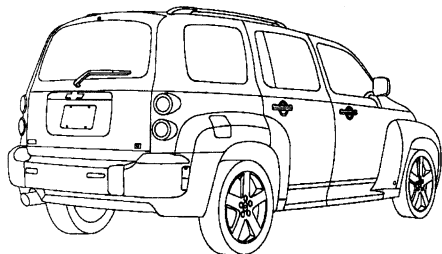

|  |           |
|--|-----------|
| DW01637 <sup>a b</sup> Windshield (Solar) (W/Third Visor Frit) | 29.2x55.8 |
| DD11040-41 Door F/R-L (Solar)                                  | 22.0x27.5 |
| DD11042-43 Door R/R-L (Solar)                                  | 20.5x21.5 |
| DQ11046-47 <sup>d</sup> Quarter R-L (Solar)                    | 15.0x25.0 |
| DV11044-45 Vent R/R-L (Solar)                                  | 6.0x16.0  |
| DB11048 <sup>c</sup> Back Window (Heated)(Solar)               | 16.0x41.5 |

<sup>a</sup> Urethane,Dam,Primer - 2 Tubes  
<sup>b</sup> Fast-Cure Urethane/Dam/Primer - Quantity 2  
<sup>c</sup> Urethane,Dam,Primer - 1.5 Tubes  
<sup>d</sup> Urethane,Dam,Primer - 1 Tube

**Impala 4 Door Sedan ..... 2006-2011**

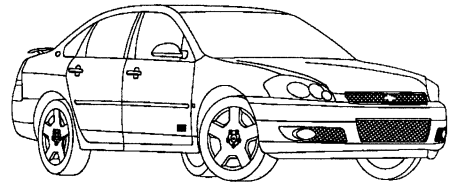

|   |           |
|---|-----------|
| DW01641 <sup>a b</sup> Windshield (Ant)(Solar) (W/Third Visor Frit, W/ Remote Start) (To 05/2007) (06-07) | 40.3x61.3 |
| DW01640 <sup>a b</sup> Windshield (Solar) (W/Third Visor Frit)  | 40.3x61.3 |
| DD11058-59 Door F/R-L (Solar)   | 23.5x33.5 |
| DD11060-61 Door R/R-L (Solar)   | 23.0x28.3 |
| DQ11062-63 <sup>c</sup> Quarter R-L (Encap)(Solar)  | 13.0x14.0 |
| DB11064 <sup>a</sup> Back Window (Ant)(Heated)(Solar)   | 32.3x50.3 |

<sup>a</sup> Urethane,Dam,Primer - 2 Tubes  
<sup>b</sup> Fast-Cure Urethane/Dam/Primer - Quantity 2  
<sup>c</sup> Urethane,Dam,Primer - 1 Tube

**LUV 4 Door Crew Cab (MEXICO ONLY) ..... 2006**

|   |           |
|---|-----------|
| FW02132 <sup>a b</sup> Windshield (Mexico Only) | 30.0x57.0 |
| FD20749-50 Door F/R-L (Mexico Only)             | 20.0x34.0 |
| FD20751-52 Door R/R-L (Mexico Only)             | 20.0x23.0 |
| FB20753 Back Window (Mexico Only)               | 14.5x54.0 |

<sup>a</sup> Urethane,Dam,Primer - 2 Tubes  
<sup>b</sup> Fast-Cure Urethane/Dam/Primer - Quantity 2

**Malibu 4 Door Sedan ..... 2008-2011**

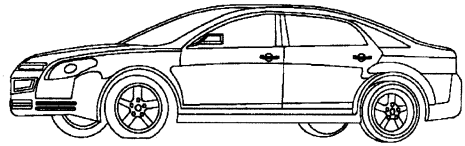

|   |           |
|---|-----------|
| DW01746 <sup>a d e</sup> Windshield (Solar) (W/Third Visor Frit)                            | 37.4x53.7 |
| DW01672 <sup>b d e</sup> Windshield (Solar) (W/Third Visor Frit, Acoustic Inter-layer) (08) | 37.4x53.7 |
| DD11236-37 Door F/R-L (Solar) (Laminated)   | 17.0x31.0 |
| DD11481-82 Door R/R-L (Solar)   | 16.0x26.0 |
| DV11483-84 Vent R/R-L (Solar)   | 9.0x11.0  |
| DB11485 <sup>f</sup> Back Window (Ant)(Heated)(Solar)                                       | 31.0x47.3 |

<sup>a</sup> Not On Production Vehicles 2008 Only  
<sup>b</sup> On Production Vehicles 2008 Only  
<sup>c</sup> On Production Vehicles 2009 & Up  
<sup>d</sup> Urethane,Dam,Primer - 2 Tubes  
<sup>e</sup> Fast-Cure Urethane/Dam/Primer - Quantity 2  
<sup>f</sup> Urethane,Dam,Primer - 1.5 Tubes

**Malibu 4 Door Sedan ..... 2006-2007**  
**Malibu Classic 4 Door Sedan ..... 2008**

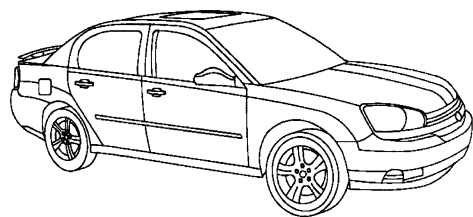

|  |           |
|--|-----------|
| DW01531 <sup>a b</sup> Windshield (Solar) (W/Third Visor Frit) (06-08) | 36.8x59.6 |
| DD10486-87 Door F/R-L (Solar) (06-08)                                  | 21.0x35.9 |

**Malibu (cont.)**

|                            |  |           |
|----------------------------|--|-----------|
| <b>DD10488-89</b>          | Door R/R-L (Solar) (06-08)               | 22.9x27.9 |
| <b>DV10490-91</b>          | Vent R/R-L (Encap)(Solar) (06-08)        | 9.0x15.5  |
| <b>DB10492<sup>c</sup></b> | Back Window (Ant)(Heated)(Solar) (06-08) | 26.9x52.9 |

<sup>a</sup> Urethane,Dam,Primer - 2 Tubes  
<sup>b</sup> Fast-Cure Urethane/Dam/Primer - Quantity 2  
<sup>c</sup> Urethane,Dam,Primer - 1.5 Tubes

**Malibu Maxx 4 Door Hatchback ..... 2006-2007**

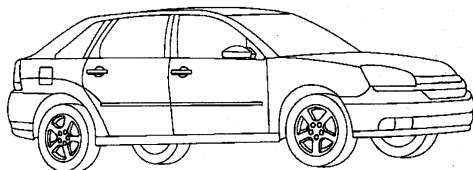

|                               |  |           |
|-------------------------------|--|-----------|
| <b>DW01531<sup>a,b</sup></b>  | Windshield (Solar) (W/Third Visor Frit)        | 36.8x59.6 |
| <b>DD10486-87</b>             | Door F/R-L (Solar)                             | 21.0x35.9 |
| <b>DD10663-64</b>             | Door R/R-L (1 Holes)(Solar)                    | 23.8x30.8 |
| <b>DR10980</b>                | Roof (Solar)                                   |           |
| <b>DQ10665-66<sup>d</sup></b> | Quarter R-L (Encap)(Solar)                     | 15.5x21.5 |
| <b>DB10979<sup>c</sup></b>    | Back Window (Heated)(1 Holes)(Solar) (W/Wiper) | 24.5x51.0 |
| <b>DB10667<sup>c</sup></b>    | Back Window (Heated)(Solar)                    | 24.5x51.0 |

<sup>a</sup> Urethane,Dam,Primer - 2 Tubes  
<sup>b</sup> Fast-Cure Urethane/Dam/Primer - Quantity 2  
<sup>c</sup> Urethane,Dam,Primer - 1.5 Tubes  
<sup>d</sup> Urethane,Dam,Primer - 1 Tube

**Matiz 4 Door Hatchback (MEXICO Only) ..... 2010-2011**

|                              |   |  |
|------------------------------|---|--|
| <b>DW01671<sup>a,b</sup></b> | Windshield (Mexico Only)  |  |
| <b>DD11231-32</b>            | Door F/R-L (Mexico Only)  |  |
| <b>DD11233-34</b>            | Door R/R-L (Mexico Only)  |  |
| <b>DV11229-30</b>            | Vent F/R-L (Mexico Only)  |  |
| <b>DB11912<sup>c</sup></b>   | Back Window (Heated)(4 Holes) (Mexico Only, W/ Spoiler, High Mount Brake Light) |  |
| <b>DB11911<sup>c</sup></b>   | Back Window (Heated) (Mexico Only, High Mount Brake Light)                      |  |
| <b>DB11235<sup>c</sup></b>   | Back Window (Heated) (Mexico Only)  |  |

<sup>a</sup> Urethane,Dam,Primer - 2 Tubes  
<sup>b</sup> Fast-Cure Urethane/Dam/Primer - Quantity 2  
<sup>c</sup> Urethane,Dam,Primer - 1.5 Tubes

**Meriva 4 Door Hatchback (MEXICO Only)..... 2006-2008**

|                                |  |           |
|--------------------------------|--|-----------|
| <b>FW02742<sup>a,b,d</sup></b> | Windshield (Solar) (Mexico Only, Rain Sensor)  | 40.0x54.5 |
| <b>FW02431<sup>a,b</sup></b>   | Windshield (Solar) (Mexico Only, Solar Coated) | 40.0x54.5 |
| <b>FW02430<sup>a,b</sup></b>   | Windshield (Solar) (Mexico Only)               | 40.0x54.5 |
| <b>FD22973-74</b>              | Door F/R-L (Solar) (Mexico Only)               |           |
| <b>FD22975-76</b>              | Door R/R-L (Solar) (Mexico Only)               |           |
| <b>FQ23173-74<sup>c</sup></b>  | Quarter R-L (Ant)(Encap)(Solar) (Mexico Only)  |           |
| <b>FQ22977-78<sup>c</sup></b>  | Quarter R-L (Encap)(Solar) (Mexico Only)       |           |
| <b>FV22971-72</b>              | Vent F/R-L (Encap)(Solar) (Mexico Only)        |           |
| <b>FB22979<sup>c</sup></b>     | Back Window (Heated)(Solar) (Mexico Only)      |           |

<sup>a</sup> Urethane,Dam,Primer - 2 Tubes  
<sup>b</sup> Fast-Cure Urethane/Dam/Primer - Quantity 2  
<sup>c</sup> Urethane,Dam,Primer - 1.5 Tubes  
<sup>d</sup> Rain Sensor Kit

**Monte Carlo 2 Door Coupe ..... 2006-2009**

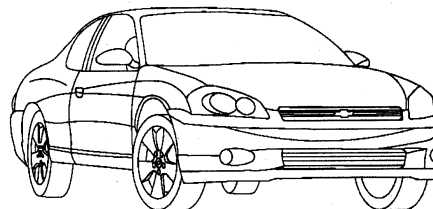

|                                 |   |           |
|---------------------------------|---|-----------|
| <b>DW01633<sup>a,b</sup></b>    | Windshield (Ant)(Solar) (W/Third Visor Frit, W/ Remote Start) | 42.0x64.0 |
| <b>DW01632<sup>a,b</sup></b>    | Windshield (Solar) (W/Third Visor Frit)                       | 42.0x64.0 |
| <b>DD09643-44</b>               | Door F/R-L (Solar)  | 21.4x45.9 |
| <b>DQ09645-46<sup>c,d</sup></b> | Quarter R-L (Encap)(Solar)                                    | 16.3x17.4 |
| <b>DB11019<sup>a</sup></b>      | Back Window (Ant)(Heated)(Solar)                              | 36.0x54.5 |

<sup>a</sup> Urethane,Dam,Primer - 2 Tubes  
<sup>b</sup> Fast-Cure Urethane/Dam/Primer - Quantity 2  
<sup>c</sup> Urethane,Dam,Primer - 1 Tube  
<sup>d</sup> Encapsulation Lubricant

**Optra 4 Door Sedan (MEXICO Only)..... 2006-2010**

|                              |                      |           |
|------------------------------|----------------------|-----------|
| <b>DW01563<sup>a,b</sup></b> | Windshield           | 34.0x54.5 |
| <b>DD10656-57</b>            | Door F/R-L           | 17.0x30.0 |
| <b>DD10658-59</b>            | Door R/R-L           | 17.0x26.5 |
| <b>DR10867</b>               | Roof (Solar)         |           |
| <b>DV10660-61</b>            | Vent R/R-L (Encap)   | 8.5x20.5  |
| <b>DB10662<sup>c</sup></b>   | Back Window (Heated) | 28.0x49.0 |

<sup>a</sup> Urethane,Dam,Primer - 2 Tubes  
<sup>b</sup> Fast-Cure Urethane/Dam/Primer - Quantity 2  
<sup>c</sup> Urethane,Dam,Primer - 1.5 Tubes

**Optra 4 Door Sedan ..... 2006 (CANADA Only)**

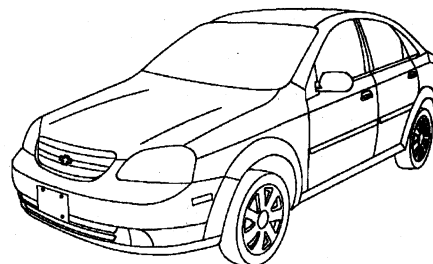

|                              |                      |           |
|------------------------------|----------------------|-----------|
| <b>DW01563<sup>a,b</sup></b> | Windshield           | 34.0x54.5 |
| <b>DD10656-57</b>            | Door F/R-L           | 17.0x30.0 |
| <b>DD10658-59</b>            | Door R/R-L           | 17.0x26.5 |
| <b>DR10867</b>               | Roof (Solar)         |           |
| <b>DV10660-61</b>            | Vent R/R-L (Encap)   | 8.5x20.5  |
| <b>DB10662<sup>c</sup></b>   | Back Window (Heated) | 28.0x49.0 |

<sup>a</sup> Urethane,Dam,Primer - 2 Tubes  
<sup>b</sup> Fast-Cure Urethane/Dam/Primer - Quantity 2  
<sup>c</sup> Urethane,Dam,Primer - 1.5 Tubes

**Optra 4 Door Station Wagon ..... 2006-2007**  
(CANADA Only)

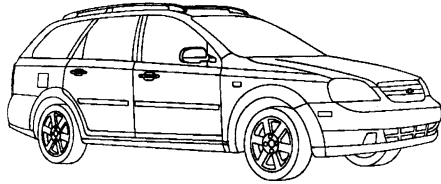

|  |                  |
|--|------------------|
| <b>DW01666<sup>a b</sup></b> Windshield (Ant)(Heated) (Heated Wiper Park Area) . | <b>34.0x54.5</b> |
| <b>DW01614<sup>a b d</sup></b> Windshield (Ant) (Rain Sensor) .....              | <b>34.0x54.5</b> |
| <b>DW01608<sup>a b</sup></b> Windshield (Ant) .....                              | <b>34.0x54.5</b> |
| <b>DD10656-57</b> Door F/R-L .....   | <b>17.0x30.0</b> |
| <b>DD10844-45</b> Door R/R-L .....   | <b>18.0x28.0</b> |
| <b>DR10867</b> Roof (Solar) .....  | <b>18.0x28.0</b> |
| <b>DQ10846-47<sup>e</sup></b> Quarter R-L .....                                  | <b>16.5x31.0</b> |
| <b>DB10848<sup>c</sup></b> Back Window (Ant)(Heated) .....                       | <b>18.5x47.5</b> |

- <sup>a</sup> Urethane,Dam,Primer - 2 Tubes
- <sup>b</sup> Fast-Cure Urethane/Dam/Primer - Quantity 2
- <sup>c</sup> Urethane,Dam,Primer - 1.5 Tubes
- <sup>d</sup> Rain Sensor Kit
- <sup>e</sup> Urethane,Dam,Primer - 1 Tube

**Optra 5 4 Door Hatchback ..... 2006-2007**  
(CANADA Only)

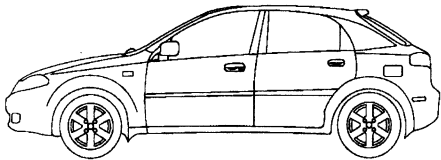

|  |                  |
|--|------------------|
| <b>DW01666<sup>a b</sup></b> Windshield (Ant)(Heated) (Heated Wiper Park Area) . | <b>34.0x54.5</b> |
| <b>DW01614<sup>a b d</sup></b> Windshield (Ant) (Rain Sensor) .....              | <b>34.0x54.5</b> |
| <b>DW01608<sup>a b</sup></b> Windshield (Ant) .....                              | <b>34.0x54.5</b> |
| <b>DD10656-57</b> Door F/R-L .....   | <b>17.0x30.0</b> |
| <b>DD10755-56</b> Door R/R-L .....   | <b>18.0x28.0</b> |
| <b>DR10867</b> Roof (Solar) .....  | <b>18.0x28.0</b> |
| <b>DB11575<sup>c</sup></b> Back Window (Heated) .....                            | <b>22.0x59.0</b> |

- <sup>a</sup> Urethane,Dam,Primer - 2 Tubes
- <sup>b</sup> Fast-Cure Urethane/Dam/Primer - Quantity 2
- <sup>c</sup> Urethane,Dam,Primer - 1.5 Tubes
- <sup>d</sup> Rain Sensor Kit

**SSR 2 Door Pickup ..... 2006**

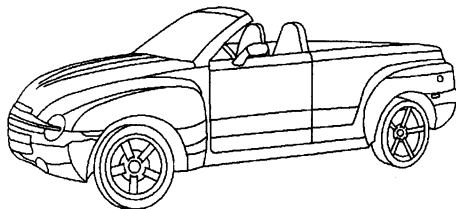

|  |                  |
|--|------------------|
| <b>DW01534<sup>a b</sup></b> Windshield (Ant) .....          | <b>37.0x57.0</b> |
| <b>DD10508-09</b> Door F/R-L .....                           | <b>23.0x44.5</b> |
| <b>DB10510<sup>c</sup></b> Back Window (Encap)(Heated) ..... | <b>20.0x61.0</b> |

- <sup>a</sup> Urethane,Dam,Primer - 2 Tubes
- <sup>b</sup> Fast-Cure Urethane/Dam/Primer - Quantity 2
- <sup>c</sup> Foam Core Butyl Tape - Quantity 1.5

|   |                  |
|---|------------------|
| <b>Silverado C1500 2 Door Extended Cab.....</b> | <b>2007-2011</b> |
| <b>Silverado C3500 2 Door Extended Cab.....</b> | <b>2007-2011</b> |
| <b>Silverado K3500 2 Door Extended Cab.....</b> | <b>2007-2011</b> |
| <b>Silverado K1500 2 Door Extended Cab.....</b> | <b>2007-2011</b> |
| <b>Silverado K2500 2 Door Extended Cab.....</b> | <b>2007-2011</b> |
| <b>Silverado C2500 2 Door Extended Cab.....</b> | <b>2007-2011</b> |

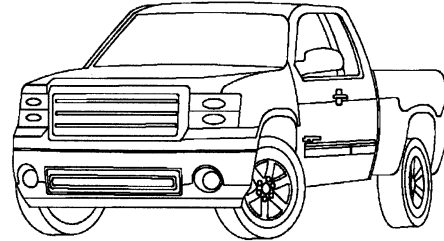

|  |                  |
|--|------------------|
| <b>DW01883<sup>a f g</sup></b> Windshield (Solar) (W/Third Visor Frit, Acoustic Inter-layer) (11) .....                      | <b>31.0x67.0</b> |
| <b>DW01658<sup>b c f g</sup></b> Windshield (Solar) (W/Third Visor Frit) .....   | <b>33.5x67.8</b> |
| <b>DD11163-64</b> Door F/R-L (Solar) .....   | <b>26.8x32.5</b> |
| <b>DQ11174-75</b> Quarter R-L (Solar) (Movable) .....  | <b>18.0x22.0</b> |
| <b>DB11388</b> Back Window C (Slider)(Solar) (OE, Power) .....   | <b>13.0x16.0</b> |
| <b>DB11386</b> Back Window C (Slider)(Solar) (OE, Manual) .....  | <b>13.0x16.0</b> |
| <b>DY90115<sup>f</sup></b> Back Window (Slider)(Solar) (Aftermarket, 1 Panel Flush Fit, Manual) .....                        | <b>17.5x64.3</b> |
| <b>DY90097<sup>f</sup></b> Back Window (Encap)(Slider)(Solar) (Aftermarket, Power, Curved, 3 Panel Encapsulated) .....       | <b>18.1x64.8</b> |
| <b>DY90096<sup>f</sup></b> Back Window (Encap)(Slider) (Aftermarket, Curved, Manual, 3 Panel Encapsulated) .....             | <b>18.1x64.8</b> |
| <b>DY90095<sup>f</sup></b> Back Window (Encap)(Slider)(Solar) (Aftermarket, Curved, Manual, 3 Panel Encapsulated) .....      | <b>18.1x64.8</b> |
| <b>DY90092<sup>f</sup></b> Back Window (Encap)(Slider) (Black Frame, Aftermarket, Manual, 3 Panel Encapsulated) .....        | <b>18.1x64.8</b> |
| <b>DY90091<sup>f</sup></b> Back Window (Encap)(Slider)(Solar) (Black Frame, Aftermarket, Manual, 3 Panel Encapsulated) ..... | <b>18.1x64.8</b> |
| <b>DY90090<sup>f</sup></b> Back Window (Encap)(Slider)(Solar) (Black Frame, Aftermarket, Power, 3 Panel Encapsulated) .....  | <b>18.1x64.8</b> |
| <b>DB11915<sup>e f</sup></b> Back Window (Slider)(Solar) (OE, Power) (11) .....  | <b>17.5x64.3</b> |
| <b>DB11914<sup>d f</sup></b> Back Window (Slider)(Solar) (Manual) (11) .....   | <b>17.5x64.3</b> |
| <b>DB11387<sup>f</sup></b> Back Window (Slider)(Solar) (OE, Power) (07-10) .....   | <b>17.5x64.3</b> |
| <b>DB11178<sup>f</sup></b> Back Window (Slider)(Solar) (Manual) (07-10) .....  | <b>17.5x64.3</b> |
| <b>DB11177<sup>f</sup></b> Back Window (Heated)(Solar) (Stationary) .....  | <b>17.5x64.3</b> |
| <b>DB11176<sup>f</sup></b> Back Window (Solar) (Stationary) .....  | <b>17.5x64.3</b> |

- <sup>a</sup> On Production Vehicles
- <sup>b</sup> Not On Production Vehicles 2011 Up
- <sup>c</sup> On Production Vehicles 2007-2010
- <sup>d</sup> Lower Corners Changed From DB11178
- <sup>e</sup> Lower Corners Changed From DB11387
- <sup>f</sup> Urethane,Dam,Primer - 2 Tubes
- <sup>g</sup> Fast-Cure Urethane/Dam/Primer - Quantity 2

|  |             |
|--|-------------|
| <b>Silverado C2500CLSC 2 Door Extended Cab</b> ..... | <b>2007</b> |
| <b>Silverado C3500CLSC 2 Door Extended Cab</b> ..... | <b>2007</b> |
| <b>Silverado C1500CLSC 2 Door Extended Cab</b> ..... | <b>2007</b> |
| <b>Silverado K1500CLSC 2 Door Extended Cab</b> ..... | <b>2007</b> |
| <b>Silverado K3500CLSC 2 Door Extended Cab</b> ..... | <b>2007</b> |
| <b>Silverado K2500CLSC 2 Door Extended Cab</b> ..... | <b>2007</b> |
| <b>Silverado K2500 HD 2 Door Extended Cab</b> .....  | <b>2006</b> |
| <b>Silverado K1500 2 Door Extended Cab</b> .....     | <b>2006</b> |
| <b>Silverado C1500 2 Door Extended Cab</b> .....     | <b>2006</b> |
| <b>Silverado C2500 HD 2 Door Extended Cab</b> .....  | <b>2006</b> |
| <b>Silverado C3500 2 Door Extended Cab</b> .....     | <b>2006</b> |
| <b>Silverado K3500 2 Door Extended Cab</b> .....     | <b>2006</b> |

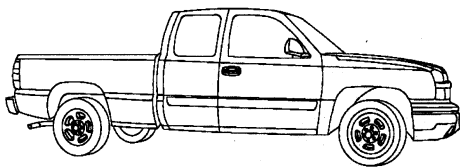

|  |                  |
|--|------------------|
| <b>DW01736<sup>a c d</sup></b> Windshield (Solar) (W/Third Visor Frit, Aftermarket, Solar Coated) (06-07) .....                      | <b>31.5x69.1</b> |
| <b>DW01549<sup>b c d</sup></b> Windshield (Solar) (W/Third Visor Frit) (06-07) .....   | <b>31.5x69.1</b> |
| <b>DD09479-80</b> Door F/R-L (Solar) (06-07) .....   | <b>26.4x32.4</b> |
| <b>DQ09481-82<sup>e</sup></b> Quarter R-L (Solar) (Movable) (06-07) .....  | <b>20.0x21.0</b> |
| <b>DY90112<sup>c</sup></b> Back Window (Slider)(Solar) (Aftermarket, 1 Panel Flush Fit, Manual) (06-07) .....                        | <b>18.1x64.8</b> |
| <b>DY90097<sup>c</sup></b> Back Window (Encap)(Slider)(Solar) (Aftermarket, Power, Curved, 3 Panel Encapsulated) (06-07) .....       | <b>18.1x64.8</b> |
| <b>DY90096<sup>c</sup></b> Back Window (Encap)(Slider) (Aftermarket, Curved, Manual, 3 Panel Encapsulated) (06-07) .....             | <b>18.1x64.8</b> |
| <b>DY90095<sup>c</sup></b> Back Window (Encap)(Slider)(Solar) (Aftermarket, Curved, Manual, 3 Panel Encapsulated) (06-07) .....      | <b>18.1x64.8</b> |
| <b>DY90092<sup>c</sup></b> Back Window (Encap)(Slider) (Black Frame, Aftermarket, Manual, 3 Panel Encapsulated) (06-07) .....        | <b>18.1x64.8</b> |
| <b>DY90091<sup>c</sup></b> Back Window (Encap)(Slider)(Solar) (Black Frame, Aftermarket, Manual, 3 Panel Encapsulated) (06-07) ..... | <b>18.1x64.8</b> |
| <b>DY90090<sup>c</sup></b> Back Window (Encap)(Slider)(Solar) (Black Frame, Aftermarket, Power, 3 Panel Encapsulated) (06-07) .....  | <b>18.1x64.8</b> |
| <b>DB09795<sup>c</sup></b> Back Window (Encap)(Slider)(Solar) (OE) (06-07) .....   | <b>17.7x63.9</b> |
| <b>DB09484<sup>c</sup></b> Back Window (Solar) (Stationary) (06-07) .....  | <b>17.7x63.9</b> |
| <b>DB09483<sup>c</sup></b> Back Window (Heated)(Solar) (Stationary) (06-07) .....  | <b>17.7x63.9</b> |

<sup>a</sup> Not On Production Vehicles  
<sup>b</sup> On Production Vehicles  
<sup>c</sup> Urethane,Dam,Primer - 2 Tubes  
<sup>d</sup> Fast-Cure Urethane/Dam/Primer - Quantity 2  
<sup>e</sup> Urethane,Dam,Primer - 1 Tube

|  |                  |
|--|------------------|
| <b>Silverado K1500 2 Door Standard Cab</b> ..... | <b>2007-2011</b> |
| <b>Silverado C2500 2 Door Standard Cab</b> ..... | <b>2007-2011</b> |
| <b>Silverado C3500 2 Door Standard Cab</b> ..... | <b>2007-2011</b> |
| <b>Silverado C1500 2 Door Standard Cab</b> ..... | <b>2007-2011</b> |
| <b>Silverado K2500 2 Door Standard Cab</b> ..... | <b>2007-2011</b> |
| <b>Silverado K3500 2 Door Standard Cab</b> ..... | <b>2007-2011</b> |

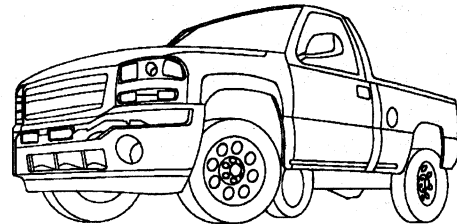

|  |                  |
|--|------------------|
| <b>DW01883<sup>a e f</sup></b> Windshield (Solar) (W/Third Visor Frit, Acoustic Inter-layer) (11) .....                      | <b>31.0x67.0</b> |
| <b>DW01658<sup>b c e f</sup></b> Windshield (Solar) (W/Third Visor Frit) .....   | <b>33.5x67.8</b> |
| <b>DD11163-64</b> Door F/R-L (Solar) .....   | <b>26.8x32.5</b> |
| <b>DB11386</b> Back Window C (Slider)(Solar) (OE, Manual) .....  | <b>13.0x16.0</b> |
| <b>DY90115<sup>e</sup></b> Back Window (Slider)(Solar) (Aftermarket, 1 Panel Flush Fit, Manual) .....                        | <b>17.5x64.3</b> |
| <b>DY90097<sup>c</sup></b> Back Window (Encap)(Slider)(Solar) (Aftermarket, Power, Curved, 3 Panel Encapsulated) .....       | <b>18.1x64.8</b> |
| <b>DY90096<sup>c</sup></b> Back Window (Encap)(Slider) (Aftermarket, Curved, Manual, 3 Panel Encapsulated) .....             | <b>18.1x64.8</b> |
| <b>DY90095<sup>c</sup></b> Back Window (Encap)(Slider)(Solar) (Aftermarket, Curved, Manual, 3 Panel Encapsulated) .....      | <b>18.1x64.8</b> |
| <b>DY90092<sup>c</sup></b> Back Window (Encap)(Slider) (Black Frame, Aftermarket, Manual, 3 Panel Encapsulated) .....        | <b>18.1x64.8</b> |
| <b>DY90091<sup>c</sup></b> Back Window (Encap)(Slider)(Solar) (Black Frame, Aftermarket, Manual, 3 Panel Encapsulated) ..... | <b>18.1x64.8</b> |
| <b>DY90090<sup>c</sup></b> Back Window (Encap)(Slider)(Solar) (Black Frame, Aftermarket, Power, 3 Panel Encapsulated) .....  | <b>18.1x64.8</b> |
| <b>DB11914<sup>d e</sup></b> Back Window (Slider)(Solar) (Manual) (11) .....   | <b>17.5x64.3</b> |
| <b>DB11178<sup>c</sup></b> Back Window (Slider)(Solar) (Manual) (07-10) .....  | <b>17.5x64.3</b> |
| <b>DB11177<sup>c</sup></b> Back Window (Heated)(Solar) (Stationary) .....  | <b>17.5x64.3</b> |
| <b>DB11176<sup>c</sup></b> Back Window (Solar) (Stationary) .....  | <b>17.5x64.3</b> |

<sup>a</sup> On Production Vehicles  
<sup>b</sup> Not On Production Vehicles 2011 Up  
<sup>c</sup> On Production Vehicles 2007-2010  
<sup>d</sup> Lower Corners Changed From DB11178  
<sup>e</sup> Urethane,Dam,Primer - 2 Tubes  
<sup>f</sup> Fast-Cure Urethane/Dam/Primer - Quantity 2

|  |             |
|--|-------------|
| <b>Silverado</b> C3500CLSC 2 Door Standard Cab ..... | <b>2007</b> |
| <b>Silverado</b> K2500CLSC 2 Door Standard Cab ..... | <b>2007</b> |
| <b>Silverado</b> C2500CLSC 2 Door Standard Cab ..... | <b>2007</b> |
| <b>Silverado</b> K3500CLSC 2 Door Standard Cab ..... | <b>2007</b> |
| <b>Silverado</b> K1500CLSC 2 Door Standard Cab ..... | <b>2007</b> |
| <b>Silverado</b> C1500CLSC 2 Door Standard Cab ..... | <b>2007</b> |
| <b>Silverado</b> K3500 2 Door Standard Cab .....     | <b>2006</b> |
| <b>Silverado</b> C1500 2 Door Standard Cab .....     | <b>2006</b> |
| <b>Silverado</b> K2500 HD 2 Door Standard Cab .....  | <b>2006</b> |
| <b>Silverado</b> K1500 2 Door Standard Cab .....     | <b>2006</b> |
| <b>Silverado</b> C3500 2 Door Standard Cab .....     | <b>2006</b> |
| <b>Silverado</b> C2500 HD 2 Door Standard Cab .....  | <b>2006</b> |

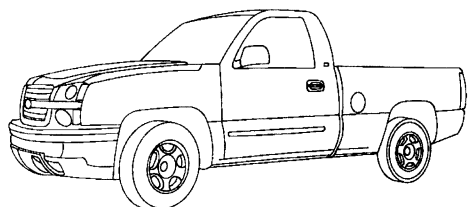

|  |                  |
|--|------------------|
| <b>DW01736<sup>a c d</sup></b> Windshield (Solar) (W/Third Visor Frit, Aftermarket, Solar Coated) (06-07) .....                      | <b>31.5x69.1</b> |
| <b>DW01549<sup>b c d</sup></b> Windshield (Solar) (W/Third Visor Frit) (06-07) .....   | <b>31.5x69.1</b> |
| <b>DD09479-80</b> Door F/R-L (Solar) (06-07) .....   | <b>26.4x32.4</b> |
| <b>DY90112<sup>c</sup></b> Back Window (Slider)(Solar) (Aftermarket, 1 Panel Flush Fit, Manual) (06-07) .....                        | <b>18.1x64.8</b> |
| <b>DY90097<sup>c</sup></b> Back Window (Encap)(Slider)(Solar) (Aftermarket, Power, Curved, 3 Panel Encapsulated) (06-07) .....       | <b>18.1x64.8</b> |
| <b>DY90096<sup>c</sup></b> Back Window (Encap)(Slider) (Aftermarket, Curved, Manual, 3 Panel Encapsulated) (06-07) .....             | <b>18.1x64.8</b> |
| <b>DY90095<sup>c</sup></b> Back Window (Encap)(Slider)(Solar) (Aftermarket, Curved, Manual, 3 Panel Encapsulated) (06-07) .....      | <b>18.1x64.8</b> |
| <b>DY90092<sup>c</sup></b> Back Window (Encap)(Slider) (Black Frame, Aftermarket, Manual, 3 Panel Encapsulated) (06-07) .....        | <b>18.1x64.8</b> |
| <b>DY90091<sup>c</sup></b> Back Window (Encap)(Slider)(Solar) (Black Frame, Aftermarket, Manual, 3 Panel Encapsulated) (06-07) ..... | <b>18.1x64.8</b> |
| <b>DY90090<sup>c</sup></b> Back Window (Encap)(Slider)(Solar) (Black Frame, Aftermarket, Power, 3 Panel Encapsulated) (06-07) .....  | <b>18.1x64.8</b> |
| <b>DB09795<sup>c</sup></b> Back Window (Encap)(Slider)(Solar) (OE) (06-07) .....   | <b>17.7x63.9</b> |
| <b>DB09484<sup>c</sup></b> Back Window (Solar) (Stationary) (06-07) .....  | <b>17.7x63.9</b> |
| <b>DB09483<sup>c</sup></b> Back Window (Heated)(Solar) (Stationary) (06-07) .....  | <b>17.7x63.9</b> |

<sup>a</sup> Not On Production Vehicles  
<sup>b</sup> On Production Vehicles  
<sup>c</sup> Urethane,Dam,Primer - 2 Tubes  
<sup>d</sup> Fast-Cure Urethane/Dam/Primer - Quantity 2

|  |                  |
|--|------------------|
| <b>Silverado</b> C2500 4 Door Crew Cab ..... | <b>2007-2011</b> |
| <b>Silverado</b> C1500 4 Door Crew Cab ..... | <b>2007-2011</b> |
| <b>Silverado</b> K1500 4 Door Crew Cab ..... | <b>2007-2011</b> |
| <b>Silverado</b> K2500 4 Door Crew Cab ..... | <b>2007-2011</b> |
| <b>Silverado</b> C3500 4 Door Crew Cab ..... | <b>2007-2011</b> |
| <b>Silverado</b> K3500 4 Door Crew Cab ..... | <b>2007-2011</b> |

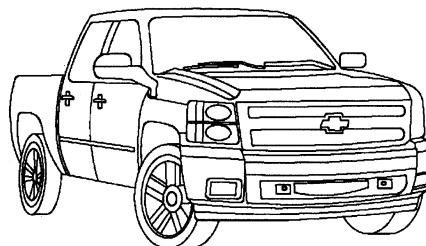

|  |                  |
|--|------------------|
| <b>DW01883<sup>b g h</sup></b> Windshield (Solar) (W/Third Visor Frit, Acoustic Inter-layer) (11) .....                      | <b>31.0x67.0</b> |
| <b>DW01659<sup>a g h</sup></b> Windshield (Solar) (W/Third Visor Frit, Rain Sensor) .....                                    | <b>33.5x67.8</b> |
| <b>DW01658<sup>c d g h</sup></b> Windshield (Solar) (W/Third Visor Frit) .....   | <b>33.5x67.8</b> |
| <b>DD11163-64</b> Door F/R-L (Solar) .....   | <b>26.8x32.5</b> |
| <b>DD11169-70</b> Door R/R-L (Solar) .....   | <b>27.3x30.0</b> |
| <b>DB11388</b> Back Window C (Slider)(Solar) (OE, Power) .....   | <b>13.0x16.0</b> |
| <b>DB11386</b> Back Window C (Slider)(Solar) (OE, Manual) .....  | <b>13.0x16.0</b> |
| <b>DY90115<sup>e</sup></b> Back Window (Slider)(Solar) (Aftermarket, 1 Panel Flush Fit, Manual) .....                        | <b>17.5x64.3</b> |
| <b>DY90097<sup>e</sup></b> Back Window (Encap)(Slider)(Solar) (Aftermarket, Power, Curved, 3 Panel Encapsulated) .....       | <b>18.1x64.8</b> |
| <b>DY90096<sup>e</sup></b> Back Window (Encap)(Slider) (Aftermarket, Curved, Manual, 3 Panel Encapsulated) .....             | <b>18.1x64.8</b> |
| <b>DY90095<sup>e</sup></b> Back Window (Encap)(Slider)(Solar) (Aftermarket, Curved, Manual, 3 Panel Encapsulated) .....      | <b>18.1x64.8</b> |
| <b>DY90092<sup>e</sup></b> Back Window (Encap)(Slider) (Black Frame, Aftermarket, Manual, 3 Panel Encapsulated) .....        | <b>18.1x64.8</b> |
| <b>DY90091<sup>e</sup></b> Back Window (Encap)(Slider)(Solar) (Black Frame, Aftermarket, Manual, 3 Panel Encapsulated) ..... | <b>18.1x64.8</b> |
| <b>DY90090<sup>e</sup></b> Back Window (Encap)(Slider)(Solar) (Black Frame, Aftermarket, Power, 3 Panel Encapsulated) .....  | <b>18.1x64.8</b> |
| <b>DB11915<sup>f g</sup></b> Back Window (Slider)(Solar) (OE, Power) (11) .....  | <b>17.5x64.3</b> |
| <b>DB11914<sup>e g</sup></b> Back Window (Slider)(Solar) (Manual) (11) .....   | <b>17.5x64.3</b> |
| <b>DB11387<sup>e</sup></b> Back Window (Slider)(Solar) (OE, Power) (07-10) .....   | <b>17.5x64.3</b> |
| <b>DB11178<sup>e</sup></b> Back Window (Slider)(Solar) (Manual) (07-10) .....  | <b>17.5x64.3</b> |
| <b>DB11177<sup>e</sup></b> Back Window (Heated)(Solar) (Stationary) .....  | <b>17.5x64.3</b> |
| <b>DB11176<sup>e</sup></b> Back Window (Solar) (Stationary) .....  | <b>17.5x64.3</b> |

<sup>a</sup> May Require Replacement of Rain Sensor  
<sup>b</sup> On Production Vehicles  
<sup>c</sup> Not On Production Vehicles 2011 Up  
<sup>d</sup> On Production Vehicles 2007-2010  
<sup>e</sup> Lower Corners Changed From DB11178  
<sup>f</sup> Lower Corners Changed From DB11387  
<sup>g</sup> Urethane,Dam,Primer - 2 Tubes  
<sup>h</sup> Fast-Cure Urethane/Dam/Primer - Quantity 2

|  |             |
|--|-------------|
| <b>Silverado K1500CLSC 4 Door Crew Cab</b> ..... | <b>2007</b> |
| <b>Silverado C3500CLSC 4 Door Crew Cab</b> ..... | <b>2007</b> |
| <b>Silverado K2500CLSC 4 Door Crew Cab</b> ..... | <b>2007</b> |
| <b>Silverado C1500CLSC 4 Door Crew Cab</b> ..... | <b>2007</b> |
| <b>Silverado K3500CLSC 4 Door Crew Cab</b> ..... | <b>2007</b> |
| <b>Silverado C2500CLSC 4 Door Crew Cab</b> ..... | <b>2007</b> |
| <b>Silverado K3500 4 Door Crew Cab</b> .....     | <b>2006</b> |
| <b>Silverado C3500 4 Door Crew Cab</b> .....     | <b>2006</b> |
| <b>Silverado K1500HD 4 Door Crew Cab</b> .....   | <b>2006</b> |
| <b>Silverado K1500 4 Door Crew Cab</b> .....     | <b>2006</b> |
| <b>Silverado C1500HD 4 Door Crew Cab</b> .....   | <b>2006</b> |
| <b>Silverado C2500 HD 4 Door Crew Cab</b> .....  | <b>2006</b> |
| <b>Silverado C1500 4 Door Crew Cab</b> .....     | <b>2006</b> |
| <b>Silverado K2500 HD 4 Door Crew Cab</b> .....  | <b>2006</b> |

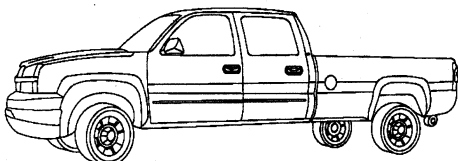

|  |                  |
|--|------------------|
| <b>DW01736<sup>a c d</sup></b> Windshield (Solar) (W/Third Visor Frit, Aftermarket, Solar Coated) (06-07) .....                      | <b>31.5x69.1</b> |
| <b>DW01549<sup>b c d</sup></b> Windshield (Solar) (W/Third Visor Frit) (06-07) .....   | <b>31.5x69.1</b> |
| <b>DD09479-80</b> Door F/R-L (Solar) (06-07) .....   | <b>26.4x32.4</b> |
| <b>DD09734-35</b> Door R/R-L (Solar) (06-07) .....   | <b>26.1x30.1</b> |
| <b>DY90112<sup>c</sup></b> Back Window (Slider)(Solar) (Aftermarket, 1 Panel Flush Fit, Manual) (06-07) .....                        | <b>18.1x64.8</b> |
| <b>DY90097<sup>c</sup></b> Back Window (Encap)(Slider)(Solar) (Aftermarket, Power, Curved, 3 Panel Encapsulated) (06-07) .....       | <b>18.1x64.8</b> |
| <b>DY90096<sup>c</sup></b> Back Window (Encap)(Slider) (Aftermarket, Curved, Manual, 3 Panel Encapsulated) (06-07) .....             | <b>18.1x64.8</b> |
| <b>DY90095<sup>c</sup></b> Back Window (Encap)(Slider)(Solar) (Aftermarket, Curved, Manual, 3 Panel Encapsulated) (06-07) .....      | <b>18.1x64.8</b> |
| <b>DY90092<sup>c</sup></b> Back Window (Encap)(Slider) (Black Frame, Aftermarket, Manual, 3 Panel Encapsulated) (06-07) .....        | <b>18.1x64.8</b> |
| <b>DY90091<sup>c</sup></b> Back Window (Encap)(Slider)(Solar) (Black Frame, Aftermarket, Manual, 3 Panel Encapsulated) (06-07) ..... | <b>18.1x64.8</b> |
| <b>DY90090<sup>c</sup></b> Back Window (Encap)(Slider)(Solar) (Black Frame, Aftermarket, Power, 3 Panel Encapsulated) (06-07) .....  | <b>18.1x64.8</b> |
| <b>DB09795<sup>c</sup></b> Back Window (Encap)(Slider)(Solar) (OE) (06-07) .....   | <b>17.7x63.9</b> |
| <b>DB09484<sup>c</sup></b> Back Window (Solar) (Stationary) (06-07) .....  | <b>17.7x63.9</b> |
| <b>DB09483<sup>c</sup></b> Back Window (Heated)(Solar) (Stationary) (06-07) .....  | <b>17.7x63.9</b> |

<sup>a</sup> Not On Production Vehicles  
<sup>b</sup> On Production Vehicles  
<sup>c</sup> Urethane,Dam,Primer - 2 Tubes  
<sup>d</sup> Fast-Cure Urethane/Dam/Primer - Quantity 2

**Spark 4 Door Hatchback (MEXICO Only)..... 2010**

|   |  |
|---|--|
| <b>DW01885<sup>a b</sup></b> Windshield (Mexico Only) .....         |  |
| <b>DD11896-97</b> Door F/R-L (Mexico Only) .....                    |  |
| <b>DD11898-99</b> Door R/R-L (Mexico Only) .....                    |  |
| <b>DV11894-95</b> Vent F/R-L (Mexico Only) .....                    |  |
| <b>DB11900<sup>c</sup></b> Back Window (Heated) (Mexico Only) ..... |  |

<sup>a</sup> Urethane,Dam,Primer - 2 Tubes  
<sup>b</sup> Fast-Cure Urethane/Dam/Primer - Quantity 2  
<sup>c</sup> Urethane,Dam,Primer - 1.5 Tubes

**Suburban 4 Door Utility ..... 2007-2011**

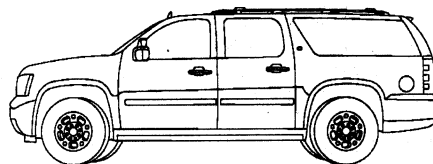

|   |                  |
|---|------------------|
| <b>DW01883<sup>b e f</sup></b> Windshield (Solar) (W/Third Visor Frit, Acoustic Inter-layer) (11) ..... | <b>31.0x67.0</b> |
| <b>DW01659<sup>a e f</sup></b> Windshield (Solar) (W/Third Visor Frit, Rain Sensor) .....               | <b>33.5x67.8</b> |
| <b>DW01658<sup>c d e f</sup></b> Windshield (Solar) (W/Third Visor Frit) .....                          | <b>33.5x67.8</b> |
| <b>DD11163-64</b> Door F/R-L (Solar) .....  | <b>26.8x32.5</b> |
| <b>DD11169-70</b> Door R/R-L (Solar) .....  | <b>27.3x30.0</b> |
| <b>DQ11172<sup>e</sup></b> Quarter L (Solar) .....  | <b>21.0x60.5</b> |
| <b>DQ11171<sup>e</sup></b> Quarter R (Ant)(Solar) .....   | <b>21.0x60.5</b> |
| <b>DB11173</b> Back Window (Heated)(3 Holes)(Solar) .....   | <b>25.0x61.5</b> |

<sup>a</sup> May Require Replacement of Rain Sensor  
<sup>b</sup> On Production Vehicles  
<sup>c</sup> Not On Production Vehicles 2011 Up  
<sup>d</sup> On Production Vehicles 2007-2010  
<sup>e</sup> Urethane,Dam,Primer - 2 Tubes  
<sup>f</sup> Fast-Cure Urethane/Dam/Primer - Quantity 2

**Suburban 4 Door Utility ..... 2006**

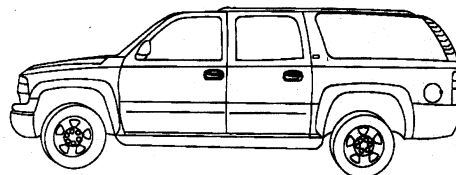

|   |                  |
|---|------------------|
| <b>DW01736<sup>a c d</sup></b> Windshield (Solar) (W/Third Visor Frit, Aftermarket, Solar Coated) ..... | <b>31.5x69.1</b> |
| <b>DW01549<sup>b c d</sup></b> Windshield (Solar) (W/Third Visor Frit) .....                            | <b>31.5x69.1</b> |
| <b>DD09479-80</b> Door F/R-L (Solar) .....  | <b>26.4x32.4</b> |
| <b>DD09734-35</b> Door R/R-L (Solar) .....  | <b>26.1x30.1</b> |
| <b>DR11694</b> Roof (Solar) .....   |                  |
| <b>DQ09736-37<sup>e</sup></b> Quarter R-L (Encap)(Solar) .....  | <b>22.0x54.0</b> |
| <b>DB09744-45<sup>e</sup></b> Back Window R-L (Encap)(Solar) .....                                      | <b>28.8x29.7</b> |
| <b>DB09742-43<sup>e</sup></b> Back Window R-L (Encap)(Heated)(Solar) .....                              | <b>28.8x29.7</b> |
| <b>DB10829</b> Back Window (Heated)(Solar) .....  | <b>27.5x61.0</b> |

<sup>a</sup> Not On Production Vehicles  
<sup>b</sup> On Production Vehicles  
<sup>c</sup> Urethane,Dam,Primer - 2 Tubes  
<sup>d</sup> Fast-Cure Urethane/Dam/Primer - Quantity 2  
<sup>e</sup> Urethane,Dam,Primer - 1.5 Tubes

**Tahoe 4 Door Utility ..... 2007-2011**

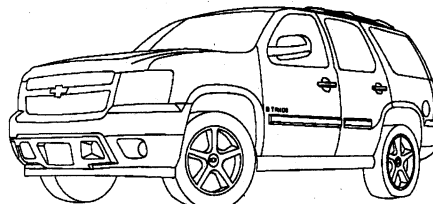

|   |                  |
|---|------------------|
| <b>DW01883<sup>b e f</sup></b> Windshield (Solar) (W/Third Visor Frit, Acoustic Inter-layer) (11) ..... | <b>31.0x67.0</b> |
| <b>DW01659<sup>a e f</sup></b> Windshield (Solar) (W/Third Visor Frit, Rain Sensor) .....               | <b>33.5x67.8</b> |
| <b>DW01658<sup>c d e f</sup></b> Windshield (Solar) (W/Third Visor Frit) .....                          | <b>33.5x67.8</b> |
| <b>DD11163-64</b> Door F/R-L (Solar) .....  | <b>26.8x32.5</b> |
| <b>DD11165-66</b> Door R/R-L (Solar) .....  | <b>26.8x30.0</b> |

| <b>Tahoe</b>         |  | <i>(cont.)</i> |
|----------------------|--|----------------|
| DQ11168 <sup>g</sup> | Quarter L (Solar)                            | 20.8x42.3      |
| DQ11167 <sup>g</sup> | Quarter R (Ant)(Solar)                       | 20.8x42.3      |
| DB11700 <sup>g</sup> | Back Window (Heated)(Solar) (Hybrid) (08-11) | 20.0x61.0      |
| DB11173              | Back Window (Heated)(3 Holes)(Solar)         | 25.0x61.5      |

<sup>a</sup> May Require Replacement of Rain Sensor  
<sup>b</sup> On Production Vehicles  
<sup>c</sup> Not On Production Vehicles 2011 Up  
<sup>d</sup> On Production Vehicles 2007-2010  
<sup>e</sup> Urethane,Dam,Primer - 2 Tubes  
<sup>f</sup> Fast-Cure Urethane/Dam/Primer - Quantity 2  
<sup>g</sup> Urethane,Dam,Primer - 1.5 Tubes

|                                       |             |
|---------------------------------------|-------------|
| <b>Tahoe LT 4 Door Utility</b> .....  | <b>2006</b> |
| <b>Tahoe Z71 4 Door Utility</b> ..... | <b>2006</b> |
| <b>Tahoe LS 4 Door Utility</b> .....  | <b>2006</b> |

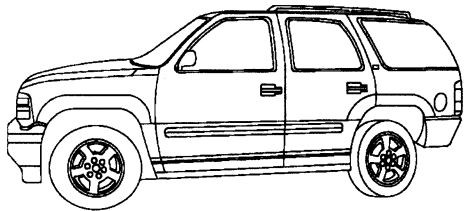

|                          |  |           |
|--------------------------|--|-----------|
| DW01736 <sup>a c d</sup> | Windshield (Solar) (W/Third Visor Frit, Aftermarket, Solar Coated) | 31.5x69.1 |
| DW01549 <sup>b c d</sup> | Windshield (Solar) (W/Third Visor Frit)                            | 31.5x69.1 |
| DD10229-30               | Door F/R-L (Solar) (Laminated)                                     | 26.4x32.2 |
| DD09479-80               | Door F/R-L (Solar)   | 26.4x32.4 |
| DD10231-32               | Door R/R-L (Solar) (Laminated)                                     | 23.5x32.0 |
| DD09738-39               | Door R/R-L (Solar)   | 23.5x32.0 |
| DR11694                  | Roof (Solar)   |           |
| DQ09740-41 <sup>e</sup>  | Quarter R-L (Encap)(Solar)   | 20.5x35.0 |
| DB09744-45 <sup>e</sup>  | Back Window R-L (Encap)(Solar)                                     | 28.8x29.7 |
| DB09742-43 <sup>e</sup>  | Back Window R-L (Encap)(Heated)(Solar)                             | 28.8x29.7 |
| DB10829                  | Back Window (Heated)(Solar)  | 27.5x61.0 |

<sup>a</sup> Not On Production Vehicles  
<sup>b</sup> On Production Vehicles  
<sup>c</sup> Urethane,Dam,Primer - 2 Tubes  
<sup>d</sup> Fast-Cure Urethane/Dam/Primer - Quantity 2  
<sup>e</sup> Urethane,Dam,Primer - 1.5 Tubes

**Tornado 2 Door Pickup (MEXICO Only)..... 2006-2011**

|                         |   |           |
|-------------------------|---|-----------|
| DW01502 <sup>a b</sup>  | Windshield (Solar) (Mexico Only)                    | 34.0x50.0 |
| DD11251-52              | Door F/R-L (Mexico Only)                            | 22.0x30.5 |
| DQ11191-92 <sup>c</sup> | Quarter R-L (Mexico Only)                           |           |
| DB11194                 | Back Window (Encap)(Slider) (Mexico Only, Assembly) |           |
| DB11193                 | Back Window (Stationary, Mexico Only)               |           |

<sup>a</sup> Urethane,Dam,Primer - 2 Tubes  
<sup>b</sup> Fast-Cure Urethane/Dam/Primer - Quantity 2  
<sup>c</sup> Urethane,Dam,Primer - 1.5 Tubes

**Tracker 4 Door Utility (MEXICO Only)..... 2006-2008**

|                         |  |           |
|-------------------------|--|-----------|
| FW02105 <sup>a b</sup>  | Windshield (Solar) (Paint Band)          | 31.0x55.0 |
| FD20522-23              | Door F/R-L (2 Holes)(Solar)              | 24.0x38.5 |
| FD20524-25              | Door R/R-L (2 Holes)(Solar)              | 19.0x24.5 |
| FQ20528-29 <sup>d</sup> | Quarter R-L (Solar) (Paint Band)         | 15.5x18.0 |
| FV20526-27              | Vent R/R-L (Solar)                       | 12.0x19.0 |
| FB20530 <sup>c</sup>    | Back Window (Heated)(Solar) (Paint Band) | 21.0x51.0 |

<sup>a</sup> Urethane,Dam,Primer - 2 Tubes  
<sup>b</sup> Fast-Cure Urethane/Dam/Primer - Quantity 2  
<sup>c</sup> Urethane,Dam,Primer - 1.5 Tubes

**Tracker** *(cont.)*

<sup>d</sup> Urethane,Dam,Primer - 1 Tube

|  |                  |
|--|------------------|
| <b>TrailBlazer LT 4 Door Utility</b> ..... | <b>2006-2009</b> |
| <b>TrailBlazer LS 4 Door Utility</b> ..... | <b>2006-2007</b> |

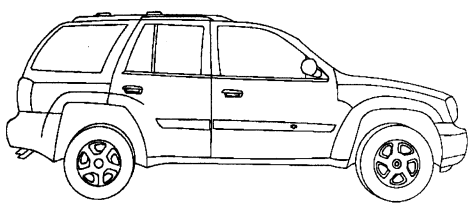

|                          |  |           |
|--------------------------|--|-----------|
| DW01611 <sup>b c d</sup> | Windshield (Solar) (W/Third Visor Frit, Acoustic Inter-layer, Rain Sensor) (06-09) | 33.4x59.6 |
| DW01610 <sup>b c d</sup> | Windshield (Solar) (W/Third Visor Frit, Acoustic Inter-layer) (06-09)              | 33.4x59.6 |
| DW01585 <sup>a c d</sup> | Windshield (Solar) (W/Third Visor Frit, Rain Sensor) (06-09)                       | 33.4x59.6 |
| DW01584 <sup>a c d</sup> | Windshield (Solar) (W/Third Visor Frit) (06-09)                                    | 33.4x59.6 |
| DW01446 <sup>c d</sup>   | Windshield (Export Only, Rain Sensor) (06-09)                                      | 33.4x59.6 |
| DW01445 <sup>c d</sup>   | Windshield (Export Only) (06-09)   | 33.4x59.6 |
| DD09965-66               | Door F/R-L (Solar) (06-09)   | 21.5x34.0 |
| DD09967-68               | Door R/R-L (Solar) (06-09)   | 18.5x21.5 |
| DQ09973-74 <sup>e</sup>  | Quarter R-L (Encap)(Solar) (06-09)   | 20.5x37.5 |
| DV09969-70               | Vent R/R-L (Encap)(Solar) (06-09)  | 10.3x19.5 |
| DB09983                  | Back Window (Heated)(Solar) (Movable) (06-09)                                      | 26.0x54.0 |
| DB09982                  | Back Window (Solar) (Movable) (06-09)  | 26.0x54.0 |

<sup>a</sup> Not On Production Vehicles  
<sup>b</sup> On Production Vehicles  
<sup>c</sup> Urethane,Dam,Primer - 2 Tubes  
<sup>d</sup> Fast-Cure Urethane/Dam/Primer - Quantity 2  
<sup>e</sup> Urethane,Dam,Primer - 1.5 Tubes

**TrailBlazer SS 4 Door Utility..... 2006-2009**

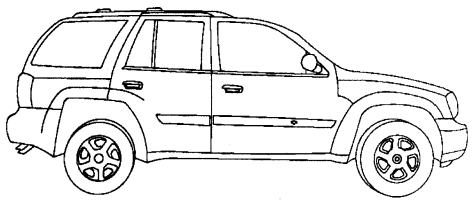

|                          |  |           |
|--------------------------|--|-----------|
| DW01611 <sup>b c d</sup> | Windshield (Solar) (W/Third Visor Frit, Acoustic Inter-layer, Rain Sensor) | 33.4x59.6 |
| DW01610 <sup>b c d</sup> | Windshield (Solar) (W/Third Visor Frit, Acoustic Inter-layer)              | 33.4x59.6 |
| DW01585 <sup>a c d</sup> | Windshield (Solar) (W/Third Visor Frit, Rain Sensor)                       | 33.4x59.6 |
| DW01584 <sup>a c d</sup> | Windshield (Solar) (W/Third Visor Frit)                                    | 33.4x59.6 |
| DD10574-75               | Door F/R-L (Solar) (Laminated)   | 21.5x34.0 |
| DD09967-68               | Door R/R-L (Solar)   | 18.5x21.5 |
| DQ09973-74 <sup>e</sup>  | Quarter R-L (Encap)(Solar)   | 20.5x37.5 |
| DV09969-70               | Vent R/R-L (Encap)(Solar)  | 10.3x19.5 |
| DB09983                  | Back Window (Heated)(Solar) (Movable)                                      | 26.0x54.0 |
| DB09982                  | Back Window (Solar) (Movable)  | 26.0x54.0 |

<sup>a</sup> Not On Production Vehicles  
<sup>b</sup> On Production Vehicles  
<sup>c</sup> Urethane,Dam,Primer - 2 Tubes  
<sup>d</sup> Fast-Cure Urethane/Dam/Primer - Quantity 2  
<sup>e</sup> Urethane,Dam,Primer - 1.5 Tubes



**TrailBlazer EXT LT 4 Door Utility ..... 2006**  
**TrailBlazer EXT LS 4 Door Utility ..... 2006**  
**TrailBlazer EXT 4 Door Utility ..... 2006**

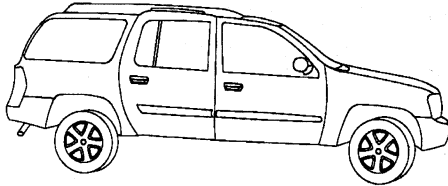

**DW01611<sup>b c d</sup>** Windshield (Solar) (W/Third Visor Frit, Acoustic Inter-layer, Rain Sensor) ..... **33.4x59.6**  
**DW01610<sup>b c d</sup>** Windshield (Solar) (W/Third Visor Frit, Acoustic Inter-layer) ..... **33.4x59.6**  
**DW01585<sup>a c d</sup>** Windshield (Solar) (W/Third Visor Frit, Rain Sensor) ..... **33.4x59.6**  
**DW01584<sup>a c d</sup>** Windshield (Solar) (W/Third Visor Frit) ..... **33.4x59.6**  
**DW01446<sup>c d</sup>** Windshield (Export Only, Rain Sensor) ..... **33.4x59.6**  
**DW01445<sup>c d</sup>** Windshield (Export Only) ..... **33.4x59.6**  
**DD09965-66** Door F/R-L (Solar) ..... **21.5x34.0**  
**DD10305-06** Door R/R-L (Solar) ..... **22.0x22.8**  
**DQ10900-01<sup>e</sup>** Quarter R-L (Encap)(Solar) (Stationary) ..... **19.8x43.0**  
**DQ10309-10<sup>f</sup>** Quarter R-L (Encap)(1 Holes)(Solar) (Movable) ..... **19.8x43.0**  
**DV10307-08** Vent R/R-L (Encap)(Solar) ..... **8.0x18.5**  
**DB11124** Back Window (2 Holes)(Solar) (Movable) ..... **28.5x55.0**  
**DB10317** Back Window (Heated)(2 Holes)(Solar) ..... **28.5x55.0**

<sup>a</sup> Not On Production Vehicles  
<sup>b</sup> On Production Vehicles  
<sup>c</sup> Urethane,Dam,Primer - 2 Tubes  
<sup>d</sup> Fast-Cure Urethane/Dam/Primer - Quantity 2  
<sup>e</sup> Urethane,Dam,Primer - 1.5 Tubes  
<sup>f</sup> Foam Core Butyl Tape - Quantity 1.5

**Traverse 4 Door Utility ..... 2009-2011**

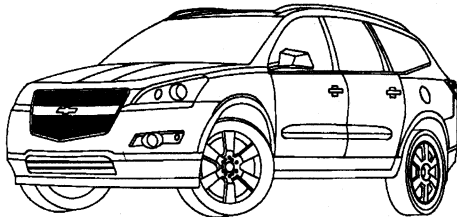

**DW01712<sup>a b</sup>** Windshield (Solar) (W/Third Visor Frit) ..... **40.0x64.0**  
**DD11267-68** Door F/R-L (Solar) ..... **27.5x33.5**  
**DD11687-88** Door R/R-L (Solar) ..... **24.0x29.5**  
**DQ11691-92<sup>c</sup>** Quarter R-L (Encap)(Solar) (Chrome Moulding) ..... **17.0x40.0**  
**DQ11689-90<sup>c</sup>** Quarter R-L (Encap)(Solar) (Black Moulding) ..... **17.0x40.0**  
**DB11693<sup>c</sup>** Back Window (Heated)(Solar) ..... **17.5x56.0**

<sup>a</sup> Urethane,Dam,Primer - 2 Tubes  
<sup>b</sup> Fast-Cure Urethane/Dam/Primer - Quantity 2  
<sup>c</sup> Urethane,Dam,Primer - 1.5 Tubes

**Uplander Mini Van ..... 2006-2009**

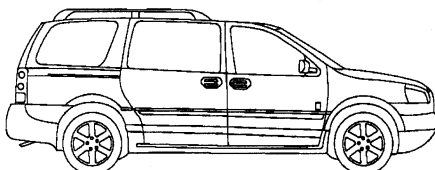

**DW01722<sup>a c d</sup>** Windshield (Solar) (W/Third Visor Frit) (From 06/01/2007) (07-09) ..... **48.2x62.1**

**Uplander (cont.)**

**DW01574<sup>a c d</sup>** Windshield (Solar) (To 05/31/2007) (06-07) ..... **48.2x62.1**  
**DD10714-15** Door F/R-L (2 Holes)(Solar) ..... **24.8x37.5**  
**DD11029-30<sup>b</sup>** Door R/R-L (Encap)(Solar) (Sliding Cargo Door) ..... **24.5x42.4**  
**DD10997-98<sup>b</sup>** Door R/R-L (Solar) (Sliding Cargo Door, Extended Van) ..... **24.5x45.5**  
**DQ10851-52** Quarter R-L (Encap)(Solar) ..... **21.5x35.0**  
**DQ10718-19** Quarter R-L (Encap)(1 Holes)(Solar) (Extended Van) .....  
**DB10868<sup>b</sup>** Back Window (Solar) ..... **23.4x57.3**  
**DB10720<sup>b</sup>** Back Window (Heated)(1 Holes)(Solar) (W/Wiper) ... **23.4x57.3**  
<sup>a</sup> May Require Two Person Installation  
<sup>b</sup> Urethane,Dam,Primer - 1.5 Tubes  
<sup>c</sup> Urethane,Dam,Primer - 2.5 Tubes  
<sup>d</sup> Fast-Cure Urethane/Dam/Primer - Quantity 2.5

**Vectra 4 Door Sedan (MEXICO Only) ..... 2006-2008**

**DW01599<sup>a b</sup>** Windshield (Ant) (Mexico Only) .....  
**DW01598<sup>a b</sup>** Windshield (Solar) (Mexico Only) .....  
**DD10805-06** Door F/R-L (Mexico Only) .....  
**DD10807-08** Door R/R-L (Mexico Only) .....  
**DV10809-10** Vent R/R-L (Mexico Only) .....  
**DB10811<sup>c</sup>** Back Window (Mexico Only) .....  
<sup>a</sup> Urethane,Dam,Primer - 2 Tubes  
<sup>b</sup> Fast-Cure Urethane/Dam/Primer - Quantity 2  
<sup>c</sup> Urethane,Dam,Primer - 1.5 Tubes

**Volt 4 Door Hatchback ..... 2011**

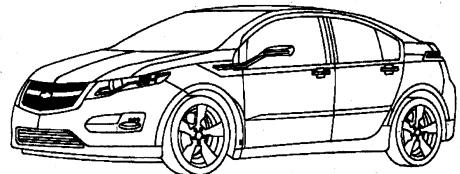

**DW01886<sup>a b</sup>** Windshield (Ant)(Solar) (W/Third Visor Frit, Acoustic Interlayer) .....  
**DD11903-04** Door F/R-L (Solar) .....  
**DD11905-06** Door R/R-L (Solar) .....  
**DV11901-02** Vent F/R-L (Solar) .....  
**DV11907-08** Vent R/R-L (Solar) .....  
**DB11910<sup>c</sup>** Back Window Lower (Heated)(Solar) .....  
**DB11909<sup>c</sup>** Back Window Upper (Heated)(Solar) .....  
<sup>a</sup> Urethane,Dam,Primer - 2 Tubes  
<sup>b</sup> Fast-Cure Urethane/Dam/Primer - Quantity 2  
<sup>c</sup> Urethane,Dam,Primer - 1.5 Tubes

**Zafira Mini Van (MEXICO Only) ..... 2006**

**DW01791<sup>a b d</sup>** Windshield (Solar) (Mexico Only, Solar Coated, Rain Sensor) .....  
**DW01790<sup>a b</sup>** Windshield (Solar) (Mexico Only, Solar Coated) .....  
**DW01789<sup>a b d</sup>** Windshield (Solar) (Mexico Only, Rain Sensor) .....  
**DW01788<sup>a b</sup>** Windshield (Solar) (Mexico Only) .....  
**DD11662-63** Door F/R-L (Mexico Only) .....  
**DD11664-65** Door R/R-L (Mexico Only) .....  
**DQ11669<sup>c</sup>** Quarter L (Encap) (Mexico Only) .....  
**DQ11674-75<sup>c</sup>** Quarter R-L (Encap) (Chrome Moulding, Mexico Only, W/Alarm) .....  
**DQ11672-73<sup>c</sup>** Quarter R-L (Encap) (Chrome Moulding, Mexico Only) .....  
**DQ11670-71<sup>c</sup>** Quarter R-L (Encap) (Black Moulding, Mexico Only, W/Alarm) .....  
**DQ11668<sup>c</sup>** Quarter R (Encap) (Black Moulding, Mexico Only) ....

**Zafira (cont.)**

DV11660-61<sup>c</sup> Vent F/R-L (Encap) (Chrome Moulding, Mexico Only)

DV11658-59<sup>c</sup> Vent F/R-L (Encap) (Black Moulding, Mexico Only) ..

DV11666-67 Vent R/R-L (Mexico Only) .....

DB11676<sup>c</sup> Back Window (Mexico Only) .....

- <sup>a</sup> Urethane,Dam,Primer - 2 Tubes
- <sup>b</sup> Fast-Cure Urethane/Dam/Primer - Quantity 2
- <sup>c</sup> Urethane,Dam,Primer - 1.5 Tubes
- <sup>d</sup> Rain Sensor Kit



**200 4 Door Sedan..... 2011**

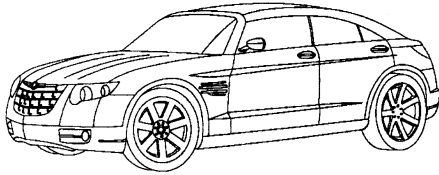

- DW01853<sup>a b</sup> Windshield (Solar) (W/Third Visor Frit, Acoustic Inter-layer) ..... **34.1x58.3**
- DD11892-93 Door F/R-L (Laminated) ..... **22.0x32.3**
- DD11311-12 Door R/R-L (1 Holes) ..... **17.5x25.5**
- DV11318-19 Vent R/R-L ..... **6.0x11.0**
- DB11865<sup>c</sup> Back Window (Heated)(Solar) (20 Amp) ..... **26.5x49.5**

- <sup>a</sup> Urethane,Dam,Primer - 2 Tubes
- <sup>b</sup> Fast-Cure Urethane/Dam/Primer - Quantity 2
- <sup>c</sup> Urethane,Dam,Primer - 1.5 Tubes

**300 4 Door Sedan..... 2006-2010**

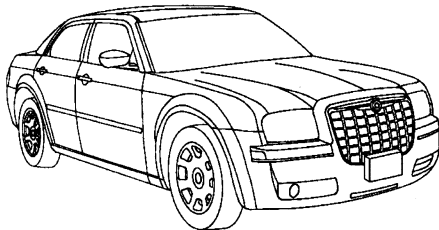

- DW01660<sup>a b</sup> Windshield (Rain Sensor) (From 01/17/2006) ..... **35.5x65.5**
- DW01572<sup>a b</sup> Windshield (Rain Sensor) (To 01/17/2006) (06) ..... **35.5x65.5**
- DW01571<sup>a b</sup> Windshield ..... **35.5x65.5**
- DD10705-06 Door F/R-L (Solar) ..... **27.5x32.5**
- DD10707-08 Door R/R-L (Solar) ..... **21.5x30.5**
- DB11678<sup>c</sup> Back Window (Ant)(Heated)(Solar) (09-10) ..... **26.0x52.5**
- DB11488<sup>c</sup> Back Window (Heated)(Solar) (08) ..... **26.0x52.5**
- DB11433<sup>c</sup> Back Window (Ant)(Heated)(Solar) (From 05/18/2007) (07) ..... **26.0x52.5**
- DB10709<sup>c</sup> Back Window (Ant)(Encap)(Heated)(Solar) (To 05/18/2007) (06-07) ..... **26.0x52.5**

- <sup>a</sup> Urethane,Dam,Primer - 2 Tubes
- <sup>b</sup> Fast-Cure Urethane/Dam/Primer - Quantity 2
- <sup>c</sup> Urethane,Dam,Primer - 1.5 Tubes

**Aspen 4 Door Utility..... 2007-2009**

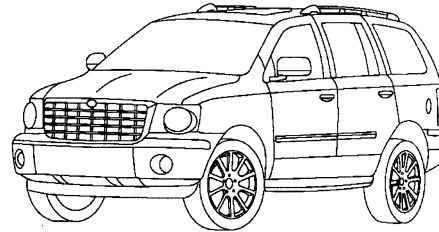

- DW01783<sup>c e f</sup> Windshield (W/Third Visor Frit, Acoustic Interlayer) (09) ..... **38.9x58.1**
- DW01555<sup>d e f</sup> Windshield (W/Third Visor Frit) ..... **38.9x58.1**
- DD11027-28 Door F/R-L ..... **20.4x33.6**
- DD10612-13 Door F/R-L (Laminated, Secure Shield Logo) ..... **20.4x33.6**
- DD11325-26 Door R/R-L (Solar) (Laminated, Secure Shield Logo) ..... **21.0x25.4**
- DD10616-17 Door R/R-L (Solar) ..... **21.0x25.4**
- DQ11010<sup>a b h</sup> Quarter L (Solar) (W/Power Liftgate) ..... **16.7x30.5**
- DQ10624<sup>h</sup> Quarter R (Solar) ..... **16.7x30.5**
- DV11327-28 Vent R/R-L (Solar) (Laminated, Secure Shield Logo) . **7.5x19.0**
- DB11574<sup>f</sup> Back Window (Heated)(Solar) (12 Grid Lines) (From 11/19/2007) (08-09) ..... **17.9x49.3**
- DB10627<sup>g</sup> Back Window (Heated)(Solar) (To 11/19/2007) (07-08) ..... **17.9x49.3**

- <sup>a</sup> Paint Band Change to hide Power B/L wires & Qtr Pillar Trim
- <sup>b</sup> Also Used On Vehicles W/O Power Liftgate
- <sup>c</sup> On Production Vehicles
- <sup>d</sup> Not On Production Vehicles 2009 Only
- <sup>e</sup> Urethane,Dam,Primer - 2 Tubes
- <sup>f</sup> Fast-Cure Urethane/Dam/Primer - Quantity 2
- <sup>g</sup> Urethane,Dam,Primer - 1.5 Tubes
- <sup>h</sup> Urethane,Dam,Primer - 1 Tube

**Cirrus 2 Door Convertible (MEXICO Only)..... 2008-2010**

- DW01711<sup>a b</sup> Windshield (W/Third Visor Frit) ..... **35.2x60.3**
- DD11379-80 Door F/R-L (1 Holes)(Solar) ..... **24.8x43.5**
- DQ11381-82 Quarter R-L (Solar) ..... **24.8x25.5**
- DB11385<sup>c</sup> Back Window (Encap)(Heated)(Solar) ..... **19.0x41.5**

- <sup>a</sup> Urethane,Dam,Primer - 2 Tubes
- <sup>b</sup> Fast-Cure Urethane/Dam/Primer - Quantity 2
- <sup>c</sup> Urethane,Dam,Primer - 1.5 Tubes

**Cirrus 4 Door Sedan (MEXICO Only)..... 2007-2011**

- DW01853<sup>a b</sup> Windshield (Solar) (W/Third Visor Frit, Acoustic Inter-layer) (11) ..... **34.1x58.3**
- DW01683<sup>a b</sup> Windshield (Solar) (W/Third Visor Frit) (07-10) ..... **34.1x58.3**
- DD11892-93 Door F/R-L (Laminated) (11) ..... **22.0x32.3**
- DD11309-10 Door F/R-L (2 Holes) (07-10) ..... **22.0x32.3**
- DD11311-12 Door R/R-L (1 Holes) ..... **17.5x25.5**
- DV11318-19 Vent R/R-L ..... **6.0x11.0**
- DB11865 Back Window (Heated)(Solar) (20 Amp) (11) ..... **26.5x49.5**
- DB11313<sup>c</sup> Back Window (Heated)(Solar) (25 Amp) (07-10) ..... **26.5x49.5**

- <sup>a</sup> Urethane,Dam,Primer - 2 Tubes
- <sup>b</sup> Fast-Cure Urethane/Dam/Primer - Quantity 2
- <sup>c</sup> Urethane,Dam,Primer - 1.5 Tubes

**Crossfire 2 Door Convertible ..... 2006-2008**

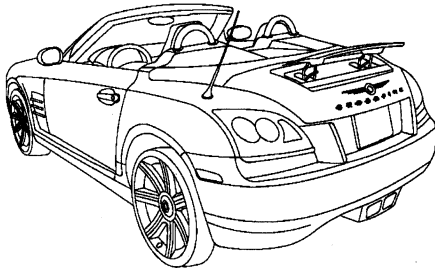

|  |                  |
|--|------------------|
| <b>DW01540<sup>a</sup></b> Windshield .....                | <b>27.6x55.1</b> |
| <b>DD10774-75</b> Door F/R-L (1 Holes) .....               |                  |
| <b>DB10776</b> Back Window (Glass Only, Aftermarket) ..... |                  |

<sup>a</sup> Non-Conductive Urethane,Dam,Primer - 2 Tubes

**Crossfire 2 Door Coupe ..... 2006-2008**

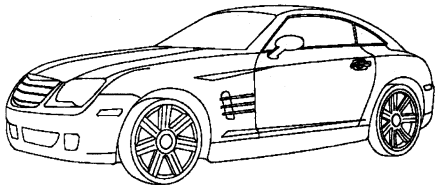

|  |                  |
|--|------------------|
| <b>DW01540<sup>a</sup></b> Windshield .....                | <b>27.6x55.1</b> |
| <b>DD10546-47</b> Door F/R-L (1 Holes) .....               | <b>18.7x41.7</b> |
| <b>DQ10548-49<sup>c</sup></b> Quarter R-L (Encap) .....    | <b>9.5x18.1</b>  |
| <b>DB10550<sup>b</sup></b> Back Window (Ant)(Heated) ..... | <b>27.7x35.1</b> |

<sup>a</sup> Non-Conductive Urethane,Dam,Primer - 2 Tubes

<sup>b</sup> Non-Conductive Urethane,Dam,Primer - 1.5 Tubes

<sup>c</sup> Non-Conductive Urethane,Dam,Primer - 1 Tube

**PT Cruiser 2 Door Convertible ..... 2006-2008**

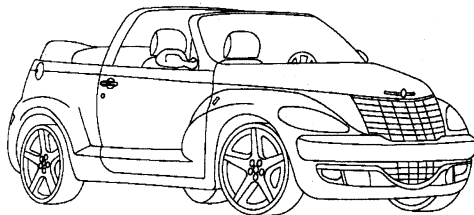

|   |                  |
|---|------------------|
| <b>DW01553<sup>a,b</sup></b> Windshield (Encap) .....             | <b>33.1x59.4</b> |
| <b>DD10607-08</b> Door F/R-L (2 Holes)(Solar) .....               | <b>23.0x39.5</b> |
| <b>DQ10609-10</b> Quarter R-L (3 Holes)(Solar) .....              | <b>18.5x21.0</b> |
| <b>DB10796</b> Back Window (Heated) (To 02/19/2007) (06-07) ..... | <b>14.5x39.0</b> |

<sup>a</sup> Urethane,Dam,Primer - 2 Tubes

<sup>b</sup> Fast-Cure Urethane/Dam/Primer - Quantity 2

**PT Cruiser 4 Door Hatchback ..... 2006-2010**

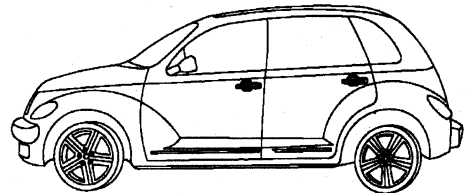

|   |                  |
|---|------------------|
| <b>DW01465<sup>a,b</sup></b> Windshield (Encap)(Solar) (W/Third Visor Frit) .....               | <b>33.1x59.4</b> |
| <b>DD09702-03</b> Door F/R-L (Solar) .....  | <b>23.6x30.3</b> |
| <b>DD09704-05</b> Door R/R-L (Solar) .....  | <b>23.2x29.1</b> |
| <b>DQ09708-09<sup>d</sup></b> Quarter R-L (Encap)(Solar) .....                                  | <b>17.3x19.3</b> |
| <b>DB11563<sup>c</sup></b> Back Window (Heated)(2 Holes)(Solar) (From 12/14/2007) (08-10) ..... | <b>25.4x45.1</b> |
| <b>DB10611<sup>c</sup></b> Back Window (Heated)(2 Holes)(Solar) (To 12/14/2007) (06-08) .....   | <b>25.2x44.9</b> |

<sup>a</sup> Urethane,Dam,Primer - 2 Tubes

<sup>b</sup> Fast-Cure Urethane/Dam/Primer - Quantity 2

<sup>c</sup> Urethane,Dam,Primer - 1.5 Tubes

<sup>d</sup> Foam Core Butyl Tape - Quantity 1

**Pacifica 4 Door Utility ..... 2006-2008**

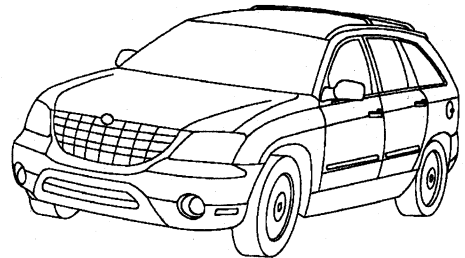

|  |                  |
|--|------------------|
| <b>DW01709<sup>b,c</sup></b> Windshield (W/Third Visor Frit) (08) .....            | <b>40.0x65.0</b> |
| <b>DW01526<sup>b,c</sup></b> Windshield (Solar) (W/Third Visor Frit) (06-07) ..... | <b>40.0x65.0</b> |
| <b>DD10591-92</b> Door F/R-L (Laminated, Secure Shield Logo) .....                 | <b>22.2x35.2</b> |
| <b>DD10436-37</b> Door F/R-L .....   | <b>22.2x35.2</b> |
| <b>DD10593-94</b> Door R/R-L (Laminated, Secure Shield Logo) .....                 | <b>20.1x25.2</b> |
| <b>DD10438-39</b> Door R/R-L .....   | <b>20.1x25.2</b> |
| <b>DQ10842<sup>d</sup></b> Quarter L (Black Moulding) .....                        | <b>18.0x30.8</b> |
| <b>DQ10443<sup>d</sup></b> Quarter L (Chrome Moulding) .....                       | <b>18.0x30.8</b> |
| <b>DQ11321<sup>d</sup></b> Quarter R (Black Moulding) (07-08) .....                | <b>18.0x30.8</b> |
| <b>DQ11320<sup>d</sup></b> Quarter R (Chrome Moulding) (07-08) .....               | <b>18.0x30.8</b> |
| <b>DQ10977<sup>a,d</sup></b> Quarter R (Ant) (Black Moulding) (06) .....           | <b>18.0x30.8</b> |
| <b>DQ10976<sup>a,d</sup></b> Quarter R (Ant) (Chrome Moulding) (06) .....          | <b>18.0x30.8</b> |
| <b>DV10440-41</b> Vent R/R-L .....   | <b>8.7x17.0</b>  |
| <b>DB11200<sup>b</sup></b> Back Window (Heated)(1 Holes) (07-08) .....             | <b>26.5x55.0</b> |
| <b>DB10444<sup>b</sup></b> Back Window (Heated)(1 Holes) (06) .....                | <b>26.5x55.0</b> |

<sup>a</sup> Two Pin Antenna Connector

<sup>b</sup> Urethane,Dam,Primer - 2 Tubes

<sup>c</sup> Fast-Cure Urethane/Dam/Primer - Quantity 2

<sup>d</sup> Foam Core Butyl Tape - Quantity 1

**Sebring 2 Door Convertible ..... 2008-2011**

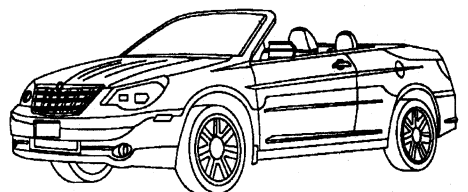

**Sebring (cont.)**

|                       |                                    |           |
|-----------------------|------------------------------------|-----------|
| DW0171 <sup>a b</sup> | Windshield (W/Third Visor Frit)    | 35.2x60.3 |
| DD11379-80            | Door F/R-L (1 Holes)(Solar)        | 24.8x43.5 |
| DQ11381-82            | Quarter R-L (Solar)                | 24.8x25.5 |
| DB11385 <sup>c</sup>  | Back Window (Encap)(Heated)(Solar) | 19.0x41.5 |

<sup>a</sup> Urethane,Dam,Primer - 2 Tubes  
<sup>b</sup> Fast-Cure Urethane/Dam/Primer - Quantity 2  
<sup>c</sup> Urethane,Dam,Primer - 1.5 Tubes

**Sebring 2 Door Convertible..... 2006**

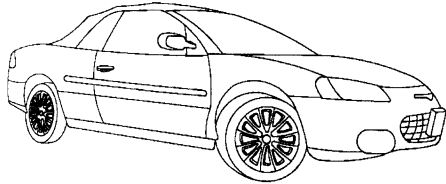

|                        |  |           |
|------------------------|--|-----------|
| DW01414 <sup>a b</sup> | Windshield (Mirror Button)                     | 34.7x62.0 |
| DD09855-56             | Door F/R-L (3 Holes)(Solar)                    | 11.8x35.4 |
| DQ09857-58             | Quarter R-L (Encap)(2 Holes)(Solar)            | 11.8x13.8 |
| DB11344                | Back Window (Cloth Top, Deep Seamist)          | 17.6x41.6 |
| DB11343                | Back Window (Cloth Top, Dark Taupe)            | 17.6x41.6 |
| DB11341                | Back Window (Black, Cloth Top)                 | 17.6x41.6 |
| DB11340                | Back Window (Vinyl Top, Black)                 | 17.6x41.6 |
| DB10894                | Back Window (Heated) (Glass Only, Aftermarket) | 17.6x41.6 |

<sup>a</sup> Urethane,Dam,Primer - 2 Tubes  
<sup>b</sup> Fast-Cure Urethane/Dam/Primer - Quantity 2

**Sebring 2 Door Coupe..... 2006**

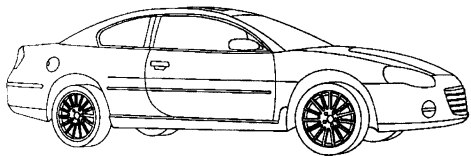

|                         |  |           |
|-------------------------|--|-----------|
| DW01516 <sup>a b</sup>  | Windshield (Electrochromic Mirror, W/Third Visor Frit) | 37.0x59.4 |
| DW01515 <sup>a b</sup>  | Windshield (W/Third Visor Frit)                        | 37.0x59.4 |
| DD09859-60              | Door F/R-L (7 Holes)                                   | 22.1x41.6 |
| DQ10371-72 <sup>c</sup> | Quarter R-L (Encap)                                    | 14.2x26.6 |
| DB09865 <sup>a</sup>    | Back Window (Heated)                                   | 39.4x50.3 |

<sup>a</sup> Urethane,Dam,Primer - 2 Tubes  
<sup>b</sup> Fast-Cure Urethane/Dam/Primer - Quantity 2  
<sup>c</sup> Urethane,Dam,Primer - 1 Tube

**Sebring 4 Door Sedan..... 2007-2010**

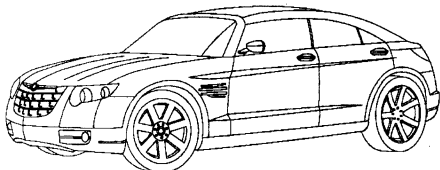

|                        |   |           |
|------------------------|---|-----------|
| DW01683 <sup>a b</sup> | Windshield (Solar) (W/Third Visor Frit) | 34.1x58.3 |
| DD11309-10             | Door F/R-L (2 Holes)                    | 22.0x32.3 |
| DD11311-12             | Door R/R-L (1 Holes)                    | 17.5x25.5 |
| DV11318-19             | Vent R/R-L                              | 6.0x11.0  |
| DB11313 <sup>c</sup>   | Back Window (Heated)(Solar) (25 Amp)    | 26.5x49.5 |

<sup>a</sup> Urethane,Dam,Primer - 2 Tubes  
<sup>b</sup> Fast-Cure Urethane/Dam/Primer - Quantity 2  
<sup>c</sup> Urethane,Dam,Primer - 1.5 Tubes

**Sebring 4 Door Sedan..... 2006**

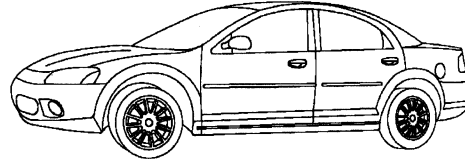

|                        |   |           |
|------------------------|---|-----------|
| DW01467 <sup>a b</sup> | Windshield (Solar) (W/Third Visor Frit) | 41.7x61.5 |
| DW01413 <sup>a b</sup> | Windshield (Solar)                      | 41.7x61.5 |
| DD09850-51             | Door F/R-L                              | 19.7x35.7 |
| DD09852-53             | Door R/R-L                              | 20.3x30.7 |
| DB09854 <sup>a</sup>   | Back Window (Heated)                    | 33.5x50.3 |

<sup>a</sup> Urethane,Dam,Primer - 2 Tubes  
<sup>b</sup> Fast-Cure Urethane/Dam/Primer - Quantity 2

**Town & Country Mini Van..... 2008-2011**

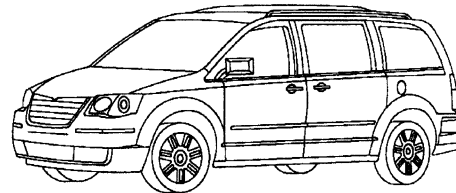

|                            |  |           |
|----------------------------|--|-----------|
| DW01819 <sup>a d e f</sup> | Windshield (Solar) (W/Third Visor Frit, Rain Sensor) (10-11) | 42.6x66.0 |
| DW01818 <sup>a e f</sup>   | Windshield (Solar) (W/Third Visor Frit) (10-11)              | 42.6x66.0 |
| DW01778 <sup>a d e f</sup> | Windshield (Solar) (W/Third Visor Frit, Rain Sensor) (09)    | 42.6x66.0 |
| DW01708 <sup>a e f</sup>   | Windshield (Solar) (W/Third Visor Frit) (08-09)              | 42.6x66.0 |
| DD11369-70                 | Door F/R-L (Solar)   | 22.3x35.1 |
| DD11373-74 <sup>c</sup>    | Door R/R-L (Solar) (Sliding Cargo Door, Movable)             | 23.6x36.1 |
| DD11371-72 <sup>c</sup>    | Door R/R-L (Solar) (Stationary, Sliding Cargo Door)          | 23.6x36.1 |
| DQ11375-76 <sup>c</sup>    | Quarter R-L (Solar) (Movable)                                | 19.0x37.8 |
| DB11378 <sup>b</sup>       | Back Window (Heated)(1 Holes)(Solar) (W/Wiper)               | 23.3x55.5 |
| DB11377 <sup>b</sup>       | Back Window (1 Holes)(Solar) (W/Wiper)                       | 23.3x55.5 |

<sup>a</sup> May Require Two Person Installation  
<sup>b</sup> Urethane,Dam,Primer - 1.5 Tubes  
<sup>c</sup> Foam Core Butyl Tape - Quantity 1.5  
<sup>d</sup> Rain Sensor Kit  
<sup>e</sup> Urethane,Dam,Primer - 2.5 Tubes  
<sup>f</sup> Fast-Cure Urethane/Dam/Primer - Quantity 2.5

**Town & Country Mini Van..... 2006-2007**

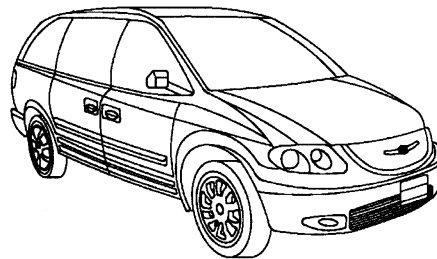

|                          |  |           |
|--------------------------|--|-----------|
| DW01470 <sup>a b c</sup> | Windshield (Solar) (W/Third Visor Frit)        | 43.0x60.0 |
| DD10586-87               | Door F/R-L (Solar)                             | 25.9x35.8 |
| DD10584-85               | Door F/R-L                                     | 25.9x35.8 |
| DD10745-46 <sup>d</sup>  | Door R/R-L (Encap)(Solar) (Sliding Cargo Door) | 23.3x39.6 |
| DQ10753-54 <sup>d</sup>  | Quarter R-L (Solar) (Power)                    | 20.8x43.4 |
| DQ10751-52 <sup>d</sup>  | Quarter R-L (Solar) (Manual)                   | 20.8x43.4 |
| DB10631 <sup>b</sup>     | Back Window (Heated)(1 Holes)(Solar) (W/Wiper) | 23.0x59.5 |

| <b>Town &amp; Country (cont.)</b>  |                  |
|--|------------------|
| <b>DB10630<sup>b</sup></b> Back Window (Heated)(1 Holes) (W/Wiper) ..... | <b>23.0x59.5</b> |
| <b>DB10629<sup>b</sup></b> Back Window (1 Holes) (W/Wiper) .....         | <b>23.0x59.5</b> |
| <sup>a</sup> May Require Two Person Installation                         |                  |
| <sup>b</sup> Urethane,Dam,Primer - 2 Tubes                               |                  |
| <sup>c</sup> Fast-Cure Urethane/Dam/Primer - Quantity 2                  |                  |
| <sup>d</sup> Foam Core Butyl Tape - Quantity 1.5                         |                  |

**Town & Country SWB Mini Van ..... 2006-2007**

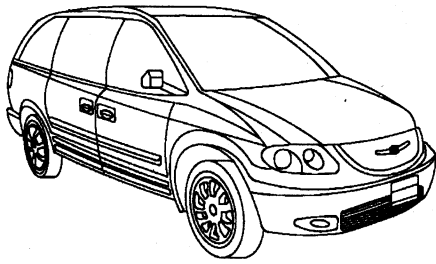

|  |                  |
|--|------------------|
| <b>DW01470<sup>a b c</sup></b> Windshield (Solar) (W/Third Visor Frit) .....       | <b>43.0x60.0</b> |
| <b>DD10586-87</b> Door F/R-L (Solar) .....   | <b>25.9x35.8</b> |
| <b>DD10584-85</b> Door F/R-L .....   | <b>25.9x35.8</b> |
| <b>DD10745-46<sup>d</sup></b> Door R/R-L (Encap)(Solar) (Sliding Cargo Door) ..... | <b>23.3x39.6</b> |
| <b>DQ10968-69<sup>d</sup></b> Quarter R-L (Solar) (W/Side Air Bags, Manual) .....  | <b>20.8x34.5</b> |
| <b>DQ10749-50<sup>d</sup></b> Quarter R-L (Solar) (Power) .....                    | <b>20.8x34.5</b> |
| <b>DQ10747-48<sup>d</sup></b> Quarter R-L (Solar) (Manual) .....                   | <b>20.8x34.5</b> |
| <b>DB10631<sup>b</sup></b> Back Window (Heated)(1 Holes)(Solar) (W/Wiper) ...      | <b>23.0x59.5</b> |
| <b>DB10630<sup>b</sup></b> Back Window (Heated)(1 Holes) (W/Wiper) .....           | <b>23.0x59.5</b> |
| <b>DB10629<sup>b</sup></b> Back Window (1 Holes) (W/Wiper) .....                   | <b>23.0x59.5</b> |
| <sup>a</sup> May Require Two Person Installation                                   |                  |
| <sup>b</sup> Urethane,Dam,Primer - 2 Tubes   |                  |
| <sup>c</sup> Fast-Cure Urethane/Dam/Primer - Quantity 2                            |                  |
| <sup>d</sup> Foam Core Butyl Tape - Quantity 1.5                                   |                  |

**Voyager Mini Van (MEXICO Only) ..... 2006-2008**

|  |                  |
|--|------------------|
| <b>DW01470<sup>a b c</sup></b> Windshield (Solar) (W/Third Visor Frit) .....       | <b>43.0x60.0</b> |
| <b>DD10586-87</b> Door F/R-L (Solar) .....   | <b>25.9x35.8</b> |
| <b>DD10584-85</b> Door F/R-L .....   | <b>25.9x35.8</b> |
| <b>DD10745-46<sup>d</sup></b> Door R/R-L (Encap)(Solar) (Sliding Cargo Door) ..... | <b>23.3x39.6</b> |
| <b>DQ10968-69<sup>d</sup></b> Quarter R-L (Solar) (W/Side Air Bags, Manual) .....  | <b>20.8x34.5</b> |
| <b>DQ10749-50<sup>d</sup></b> Quarter R-L (Solar) (Power) .....                    | <b>20.8x34.5</b> |
| <b>DQ10747-48<sup>d</sup></b> Quarter R-L (Solar) (Manual) .....                   | <b>20.8x34.5</b> |
| <b>DB10631<sup>b</sup></b> Back Window (Heated)(1 Holes)(Solar) (W/Wiper) ...      | <b>23.0x59.5</b> |
| <b>DB10630<sup>b</sup></b> Back Window (Heated)(1 Holes) (W/Wiper) .....           | <b>23.0x59.5</b> |
| <b>DB10629<sup>b</sup></b> Back Window (1 Holes) (W/Wiper) .....                   | <b>23.0x59.5</b> |
| <sup>a</sup> May Require Two Person Installation                                   |                  |
| <sup>b</sup> Urethane,Dam,Primer - 2 Tubes   |                  |
| <sup>c</sup> Fast-Cure Urethane/Dam/Primer - Quantity 2                            |                  |
| <sup>d</sup> Foam Core Butyl Tape - Quantity 1.5                                   |                  |

**Atos 4 Door Hatchback (MEXICO Only) ..... 2006-2010**

|   |                  |
|---|------------------|
| <b>DW01444<sup>a b</sup></b> Windshield (Solar) (Mexico Only) .....                   | <b>33.5x49.5</b> |
| <b>DW01442<sup>a b</sup></b> Windshield (Mexico Only) .....                           | <b>33.5x49.5</b> |
| <b>DD09939-40</b> Door F/R-L (Mexico Only) .....                                      | <b>19.5x29.7</b> |
| <b>DD09941-42</b> Door R/R-L (Mexico Only) .....                                      | <b>18.5x21.8</b> |
| <b>DV09943-44</b> Vent R/R-L (Mexico Only) .....                                      | <b>8.3x14.5</b>  |
| <b>DB11391<sup>c</sup></b> Back Window (Mexico Only) .....                            |                  |
| <b>DB11250<sup>c</sup></b> Back Window (Heated)(1 Holes) (Mexico Only, W/Wiper) ..... |                  |

| <b>Atos (cont.)</b>                                     |  |
|---|--|
| <sup>a</sup> Urethane,Dam,Primer - 2 Tubes              |  |
| <sup>b</sup> Fast-Cure Urethane/Dam/Primer - Quantity 2 |  |
| <sup>c</sup> Urethane,Dam,Primer - 1.5 Tubes            |  |

**Attitude 4 Door Sedan (MEXICO Only) ..... 2006-2011**

|   |                  |
|---|------------------|
| <b>FW02716<sup>a b</sup></b> Windshield (Solar) .....   | <b>32.9x55.5</b> |
| <b>FW02632<sup>a b</sup></b> Windshield .....           | <b>32.9x55.5</b> |
| <b>FD23033-34</b> Door F/R-L (2 Holes) .....            | <b>22.0x35.0</b> |
| <b>FD23035-36</b> Door R/R-L (2 Holes) .....            | <b>19.5x24.8</b> |
| <b>FV23037-38</b> Vent R/R-L .....                      | <b>9.3x11.8</b>  |
| <b>FB23039<sup>c</sup></b> Back Window (Heated) .....   | <b>26.8x46.8</b> |
| <sup>a</sup> Urethane,Dam,Primer - 2 Tubes              |                  |
| <sup>b</sup> Fast-Cure Urethane/Dam/Primer - Quantity 2 |                  |
| <sup>c</sup> Urethane,Dam,Primer - 1.5 Tubes            |                  |

**Avenger 4 Door Sedan ..... 2008-2011**

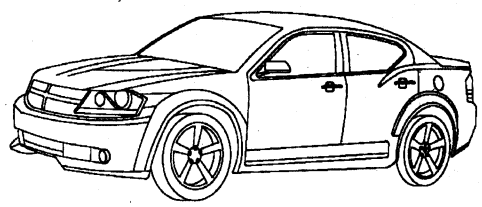

|   |                  |
|---|------------------|
| <b>DW01853<sup>a b</sup></b> Windshield (Solar) (W/Third Visor Frit, Acoustic Inter-layer) (11) ..... | <b>34.1x58.3</b> |
| <b>DW01683<sup>a b</sup></b> Windshield (Solar) (W/Third Visor Frit) (08-10) .....                    | <b>34.1x58.3</b> |
| <b>DD11892-93</b> Door F/R-L (Laminated) (11) .....   | <b>22.0x32.3</b> |
| <b>DD11309-10</b> Door F/R-L (2 Holes) (08-10) .....  | <b>22.0x32.3</b> |
| <b>DD11311-12</b> Door R/R-L (1 Holes) .....  | <b>17.5x25.5</b> |
| <b>DB11707<sup>c</sup></b> Back Window (Heated)(Solar) (09-11) .....                                  | <b>27.3x51.0</b> |
| <b>DB11314<sup>c</sup></b> Back Window (Heated)(Solar) (08) .....                                     | <b>27.3x51.0</b> |
| <sup>a</sup> Urethane,Dam,Primer - 2 Tubes  |                  |
| <sup>b</sup> Fast-Cure Urethane/Dam/Primer - Quantity 2   |                  |
| <sup>c</sup> Urethane,Dam,Primer - 1.5 Tubes  |                  |

**Caliber 4 Door Hatchback ..... 2007-2011**

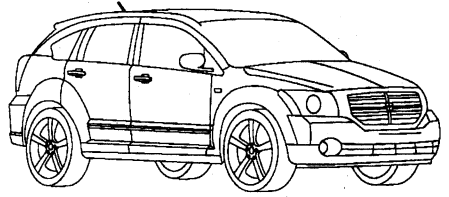

|  |                  |
|--|------------------|
| <b>DW01643<sup>a b</sup></b> Windshield (W/Third Visor Frit) .....       | <b>33.6x56.7</b> |
| <b>DD11107-08</b> Door F/R-L (2 Holes) .....                             | <b>22.8x35.8</b> |
| <b>DD11109-10</b> Door R/R-L (1 Holes) .....                             | <b>20.0x22.0</b> |
| <b>DQ11113-14<sup>d</sup></b> Quarter R-L (Encap) .....                  | <b>10.7x17.4</b> |
| <b>DV11111-12</b> Vent R/R-L .....                                       | <b>7.5x13.3</b>  |
| <b>DB11115<sup>c</sup></b> Back Window (Heated)(1 Holes) (W/Wiper) ..... | <b>20.3x42.9</b> |
| <sup>a</sup> Urethane,Dam,Primer - 2 Tubes                               |                  |
| <sup>b</sup> Fast-Cure Urethane/Dam/Primer - Quantity 2                  |                  |
| <sup>c</sup> Urethane,Dam,Primer - 1.5 Tubes                             |                  |
| <sup>d</sup> Urethane,Dam,Primer - 1 Tube                                |                  |

**Caravan Mini Van..... 2006-2007**

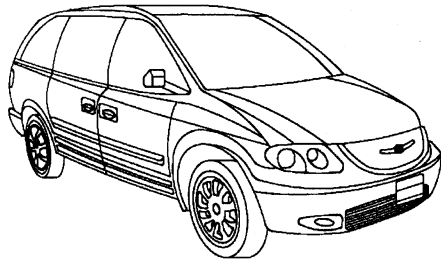

|  |           |
|--|-----------|
| DW01470 <sup>a b c</sup> Windshield (Solar) (W/Third Visor Frit) .....       | 43.0x60.0 |
| DD10586-87 Door F/R-L (Solar) .....  | 25.9x35.8 |
| DD10584-85 Door F/R-L .....  | 25.9x35.8 |
| DD10745-46 <sup>d</sup> Door R/R-L (Encap)(Solar) (Sliding Cargo Door) ..... | 23.3x39.6 |
| DQ10968-69 <sup>d</sup> Quarter R-L (Solar) (W/Side Air Bags, Manual) .....  | 20.8x34.5 |
| DQ10749-50 <sup>d</sup> Quarter R-L (Solar) (Power) .....                    | 20.8x34.5 |
| DQ10747-48 <sup>d</sup> Quarter R-L (Solar) (Manual) .....                   | 20.8x34.5 |
| DB10631 <sup>b</sup> Back Window (Heated)(1 Holes)(Solar) (W/Wiper) ...      | 23.0x59.5 |
| DB10630 <sup>b</sup> Back Window (Heated)(1 Holes) (W/Wiper) .....           | 23.0x59.5 |
| DB10629 <sup>b</sup> Back Window (1 Holes) (W/Wiper) .....                   | 23.0x59.5 |

<sup>a</sup> May Require Two Person Installation  
<sup>b</sup> Urethane,Dam,Primer - 2 Tubes  
<sup>c</sup> Fast-Cure Urethane/Dam/Primer - Quantity 2  
<sup>d</sup> Foam Core Butyl Tape - Quantity 1.5

**Challenger 2 Door Coupe..... 2008-2011**

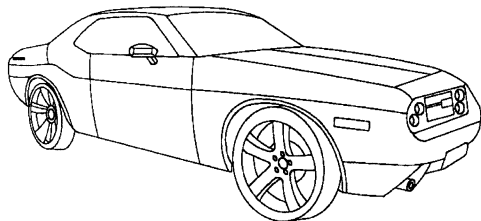

|  |           |
|--|-----------|
| DW01760 <sup>a b</sup> Windshield (W/Third Visor Frit) ..... | 32.6x61.1 |
| DD11568-69 Door F/R-L (2 Holes)(Solar) .....                 | 32.6x44.7 |
| DQ11570-71 <sup>d</sup> Quarter R-L .....                    | 14.5x17.4 |
| DB11572 <sup>c</sup> Back Window (Heated)(Solar) .....       | 20.8x53.3 |

<sup>a</sup> Urethane,Dam,Primer - 2 Tubes  
<sup>b</sup> Fast-Cure Urethane/Dam/Primer - Quantity 2  
<sup>c</sup> Urethane,Dam,Primer - 1.5 Tubes  
<sup>d</sup> Urethane,Dam,Primer - 1 Tube

**Charger 4 Door Sedan..... 2006-2010**

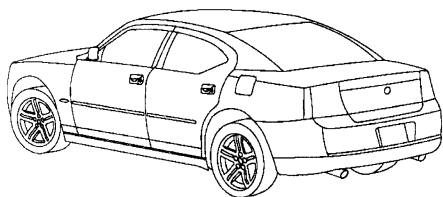

|  |           |
|--|-----------|
| DW01660 <sup>a b</sup> Windshield (Rain Sensor) (From 01/17/2006) .....    | 35.5x65.5 |
| DW01572 <sup>a b</sup> Windshield (Rain Sensor) (To 01/17/2006) (06) ..... | 35.5x65.5 |
| DW01571 <sup>a b</sup> Windshield .....                                    | 35.5x65.5 |
| DD10912-13 Door F/R-L (Solar) .....  | 21.3x35.5 |
| DD10914-15 Door R/R-L (Solar) .....  | 19.0x30.2 |
| DB11486 <sup>a</sup> Back Window (Encap)(Heated)(Solar) (08) .....         | 36.6x51.6 |

**Charger (cont.)**

|   |           |
|---|-----------|
| DB10916 <sup>c</sup> Back Window (Ant)(Encap)(Heated)(Solar) (06-07)(09-10) ..... | 36.6x51.6 |
|---|-----------|

<sup>a</sup> Urethane,Dam,Primer - 2 Tubes  
<sup>b</sup> Fast-Cure Urethane/Dam/Primer - Quantity 2  
<sup>c</sup> Urethane,Dam,Primer (06-10) - 2 Tubes

**Dakota Pickup 2 Door Club Cab..... 2006-2011**

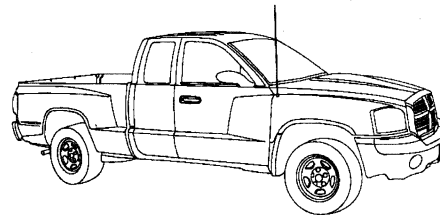

|  |           |
|--|-----------|
| DW01590 <sup>a b</sup> Windshield (W/Third Visor Frit) .....   | 35.0x62.5 |
| DD10777-78 Door F/R-L .....  | 19.0x29.0 |
| DQ10781-82 <sup>d</sup> Quarter R-L (Solar) .....  | 13.9x17.9 |
| DB10449 Back Window C (Slider)(Solar) (OE, Movable) .....  | 13.0x13.2 |
| DY90088 <sup>c</sup> Back Window (Encap)(Slider)(Solar) (Black Frame, Aftermarket, 3 Panel Encapsulated) ..... | 15.6x56.0 |
| DY90087 <sup>c</sup> Back Window (Encap)(Slider)(Solar) (Black Frame, Aftermarket, 4 Panel Encapsulated) ..... | 15.6x56.0 |
| DY90083 <sup>c</sup> Back Window (Encap)(Slider) (Aftermarket, Power, 3 Panel Encapsulated) .....              | 15.6x56.0 |
| DY90082 <sup>c</sup> Back Window (Encap)(Slider) (Aftermarket, 3 Panel Encapsulated) .....                     | 15.6x56.0 |
| DB10784 <sup>c</sup> Back Window (Heated)(Solar) (Stationary) .....  | 15.6x56.0 |
| DB10783 <sup>c</sup> Back Window (Stationary) .....  | 15.6x56.0 |
| DB10448 <sup>c</sup> Back Window (Slider)(Solar) (OE) .....  | 15.6x56.0 |

<sup>a</sup> Urethane,Dam,Primer - 2 Tubes  
<sup>b</sup> Fast-Cure Urethane/Dam/Primer - Quantity 2  
<sup>c</sup> Urethane,Dam,Primer - 1.5 Tubes  
<sup>d</sup> Foam Core Butyl Tape - Quantity 1

**Dakota Pickup 4 Door Crew Cab..... 2006-2011**

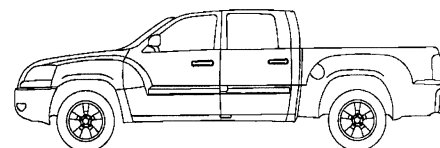

|  |           |
|--|-----------|
| DW01590 <sup>a b</sup> Windshield (W/Third Visor Frit) .....   | 35.0x62.5 |
| DD10777-78 Door F/R-L .....  | 19.0x29.0 |
| DD10779-80 Door R/R-L (Solar) .....  | 23.0x24.5 |
| DB10449 Back Window C (Slider)(Solar) (OE, Movable) .....  | 13.0x13.2 |
| DY90088 <sup>c</sup> Back Window (Encap)(Slider)(Solar) (Black Frame, Aftermarket, 3 Panel Encapsulated) ..... | 15.6x56.0 |
| DY90087 <sup>c</sup> Back Window (Encap)(Slider)(Solar) (Black Frame, Aftermarket, 4 Panel Encapsulated) ..... | 15.6x56.0 |
| DY90083 <sup>c</sup> Back Window (Encap)(Slider) (Aftermarket, Power, 3 Panel Encapsulated) .....              | 15.6x56.0 |
| DY90082 <sup>c</sup> Back Window (Encap)(Slider) (Aftermarket, 3 Panel Encapsulated) .....                     | 15.6x56.0 |
| DB10784 <sup>c</sup> Back Window (Heated)(Solar) (Stationary) .....  | 15.6x56.0 |
| DB10783 <sup>c</sup> Back Window (Stationary) .....  | 15.6x56.0 |
| DB10448 <sup>c</sup> Back Window (Slider)(Solar) (OE) .....  | 15.6x56.0 |

<sup>a</sup> Urethane,Dam,Primer - 2 Tubes  
<sup>b</sup> Fast-Cure Urethane/Dam/Primer - Quantity 2  
<sup>c</sup> Urethane,Dam,Primer - 1.5 Tubes

**Durango 4 Door Utility ..... 2011**

|   |           |
|---|-----------|
| DW01840 <sup>a b d</sup> Windshield (Solar) (W/Third Visor Frit, Rain Sensor) |           |
| DW01839 <sup>a b</sup> Windshield (Solar) (W/Third Visor Frit) .....          |           |
| DD11815-16 Door F/R-L (Solar) (Laminated) .....                               | 24.5x36.0 |
| DD11813-14 Door F/R-L (Solar) .....   | 24.5x36.0 |
| DD11916-17 Door R/R-L (Solar) .....   |           |
| DQ11918-19 <sup>c</sup> Quarter R-L (Encap)(Solar) .....                      |           |
| DBI1920 <sup>c</sup> Back Window (Heated)(1 Holes)(Solar) .....               |           |

<sup>a</sup> Urethane,Dam,Primer - 2 Tubes  
<sup>b</sup> Fast-Cure Urethane/Dam/Primer - Quantity 2.  
<sup>c</sup> Urethane,Dam,Primer - 1.5 Tubes  
<sup>d</sup> Rain Sensor Kit

**Durango 4 Door Utility ..... 2006-2009**

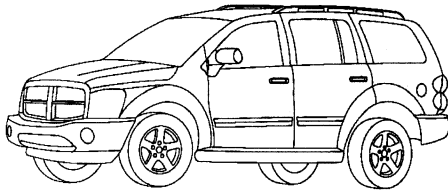

|  |           |
|--|-----------|
| DW01783 <sup>c e f</sup> Windshield (W/Third Visor Frit, Acoustic Interlayer) (09) .....         | 38.9x58.1 |
| DW01555 <sup>d e f</sup> Windshield (W/Third Visor Frit) .....                                   | 38.9x58.1 |
| DD11027-28 Door F/R-L .....  | 20.4x33.6 |
| DD10612-13 Door F/R-L (Laminated, Secure Shield Logo) .....                                      | 20.4x33.6 |
| DD11325-26 Door R/R-L (Solar) (Laminated, Secure Shield Logo) (07-09) .....                      | 21.0x25.4 |
| DD10616-17 Door R/R-L (Solar) .....  | 21.0x25.4 |
| DD10614-15 Door R/R-L .....  | 21.0x25.4 |
| DQ11010 <sup>a b h</sup> Quarter L (Solar) (W/Power Liftgate) .....                              | 16.7x30.5 |
| DQ11009 <sup>a h</sup> Quarter L (W/Power Liftgate) .....  | 16.7x30.5 |
| DQ10624 <sup>h</sup> Quarter R (Solar) .....   | 16.7x30.5 |
| DQ10622 <sup>h</sup> Quarter R .....   | 16.7x30.5 |
| DV11327-28 Vent R/R-L (Solar) (Laminated, Secure Shield Logo) (07-09) .....                      | 7.5x19.0  |
| DV10620-21 Vent R/R-L (Solar) (06) .....   | 7.5x19.0  |
| DV10618-19 Vent R/R-L .....  | 7.5x19.0  |
| DBI1574 <sup>g</sup> Back Window (Heated)(Solar) (12 Grid Lines) (From 11/19/2007) (08-09) ..... | 17.9x49.3 |
| DBI1573 <sup>g</sup> Back Window (Heated) (12 Grid Lines) (From 11/19/2007) (08-09) .....        | 17.9x49.3 |
| DB10627 <sup>g</sup> Back Window (Heated)(Solar) (To 11/19/2007) (06-08) .....                   | 17.9x49.3 |
| DB10626 <sup>g</sup> Back Window (Heated) (To 11/19/2007) (06-08) .....                          | 17.9x49.3 |

<sup>a</sup> Paint Band Change to hide Power B/L wires & Qtr Pillar Trim  
<sup>b</sup> Also Used On Vehicles W/O Power Liftgate  
<sup>c</sup> On Production Vehicles  
<sup>d</sup> Not On Production Vehicles 2009 Only  
<sup>e</sup> Urethane,Dam,Primer - 2 Tubes  
<sup>f</sup> Fast-Cure Urethane/Dam/Primer - Quantity 2  
<sup>g</sup> Urethane,Dam,Primer - 1.5 Tubes  
<sup>h</sup> Urethane,Dam,Primer - 1 Tube

**Grand Caravan Mini Van ..... 2008-2011**

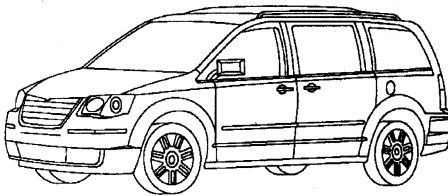

**Grand Caravan (cont.)**

|   |           |
|---|-----------|
| DW01819 <sup>a d e f</sup> Windshield (Solar) (W/Third Visor Frit, Rain Sensor) (10-11) ..... | 42.6x66.0 |
| DW01818 <sup>a e f</sup> Windshield (Solar) (W/Third Visor Frit) (10-11) .....                | 42.6x66.0 |
| DW01778 <sup>a d e f</sup> Windshield (Solar) (W/Third Visor Frit, Rain Sensor) (09) .....    | 42.6x66.0 |
| DW01708 <sup>a e f</sup> Windshield (Solar) (W/Third Visor Frit) (08-09) .....                | 42.6x66.0 |
| DD11369-70 Door F/R-L (Solar) .....   | 22.3x35.1 |
| DD11373-74 <sup>c</sup> Door R/R-L (Solar) (Sliding Cargo Door, Movable) ....                 | 23.6x36.1 |
| DD11371-72 <sup>c</sup> Door R/R-L (Solar) (Stationary, Sliding Cargo Door) ..                | 23.6x36.1 |
| DQ11375-76 <sup>c</sup> Quarter R-L (Solar) (Movable) .....                                   | 19.0x37.8 |
| DBI1378 <sup>b</sup> Back Window (Heated)(1 Holes)(Solar) (W/Wiper) ...                       | 23.3x55.5 |
| DBI1377 <sup>b</sup> Back Window (1 Holes)(Solar) (W/Wiper) .....                             | 23.3x55.5 |

<sup>a</sup> May Require Two Person Installation  
<sup>b</sup> Urethane,Dam,Primer - 1.5 Tubes  
<sup>c</sup> Foam Core Butyl Tape - Quantity 1.5  
<sup>d</sup> Rain Sensor Kit  
<sup>e</sup> Urethane,Dam,Primer - 2.5 Tubes  
<sup>f</sup> Fast-Cure Urethane/Dam/Primer - Quantity 2.5

**Grand Caravan Mini Van ..... 2006-2007**

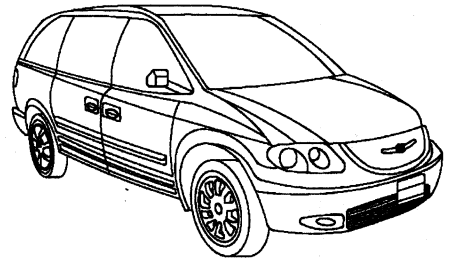

|  |           |
|--|-----------|
| DW01470 <sup>a b c</sup> Windshield (Solar) (W/Third Visor Frit) .....       | 43.0x60.0 |
| DD10586-87 Door F/R-L (Solar) .....  | 25.9x35.8 |
| DD10584-85 Door F/R-L .....  | 25.9x35.8 |
| DD10745-46 <sup>d</sup> Door R/R-L (Encap)(Solar) (Sliding Cargo Door) ..... | 23.3x39.6 |
| DQ10753-54 <sup>d</sup> Quarter R-L (Solar) (Power) .....                    | 20.8x43.4 |
| DQ10751-52 <sup>d</sup> Quarter R-L (Solar) (Manual) .....                   | 20.8x43.4 |
| DB10631 <sup>b</sup> Back Window (Heated)(1 Holes)(Solar) (W/Wiper) ...      | 23.0x59.5 |
| DB10630 <sup>b</sup> Back Window (Heated)(1 Holes) (W/Wiper) .....           | 23.0x59.5 |
| DB10629 <sup>b</sup> Back Window (1 Holes) (W/Wiper) .....                   | 23.0x59.5 |

<sup>a</sup> May Require Two Person Installation  
<sup>b</sup> Urethane,Dam,Primer - 2 Tubes  
<sup>c</sup> Fast-Cure Urethane/Dam/Primer - Quantity 2  
<sup>d</sup> Foam Core Butyl Tape - Quantity 1.5

**H100 2 Door Pickup (MEXICO Only) ..... 2006-2010**

|   |  |
|---|--|
| FW02813 <sup>a b</sup> Windshield (Mexico Only) ..... |  |
| FD23505-06 Door F/R-L (Mexico Only) .....             |  |
| FB23507 <sup>c</sup> Back Window (Mexico Only) .....  |  |

<sup>a</sup> Urethane,Dam,Primer - 2 Tubes  
<sup>b</sup> Fast-Cure Urethane/Dam/Primer - Quantity 2  
<sup>c</sup> Urethane,Dam,Primer - 1.5 Tubes

**H100 Cargo Van (MEXICO Only) ..... 2010**

|   |  |
|---|--|
| FW03234 <sup>a b</sup> Windshield (Heated)(Solar) (Mexico Only) ..... |  |
| FW03233 <sup>a b</sup> Windshield (Heated) (Mexico Only) .....        |  |
| FW03225 <sup>a b</sup> Windshield (Mexico Only) .....                 |  |
| FD24651-52 Door F/R-L (Solar) (Mexico Only) .....                     |  |
| FD24604-05 Door F/R-L (Mexico Only) .....                             |  |
| FV24602-03 <sup>c</sup> Vent F/R-L (Encap) (Mexico Only) .....        |  |
| FB24606 <sup>c</sup> Back Window (Heated) (Mexico Only) .....         |  |

<sup>a</sup> Urethane,Dam,Primer - 2 Tubes

**H100 (cont.)**  
<sup>b</sup> Fast-Cure Urethane/Dam/Primer - Quantity 2  
<sup>c</sup> Urethane,Dam,Primer - 1.5 Tubes

**H100 Van (MEXICO Only)..... 2010**

|                               |  |  |
|-------------------------------|--|--|
| <b>FW03234<sup>a b</sup></b>  | Windshield (Heated)(Solar) (Mexico Only) .....     |  |
| <b>FW03233<sup>a b</sup></b>  | Windshield (Heated) (Mexico Only) .....            |  |
| <b>FW03225<sup>a b</sup></b>  | Windshield (Mexico Only) .....                     |  |
| <b>FD24651-52</b>             | Door F/R-L (Solar) (Mexico Only) .....             |  |
| <b>FD24604-05</b>             | Door F/R-L (Mexico Only) .....                     |  |
| <b>FD24653-54</b>             | Door R/R-L (Sliding Cargo Door, Mexico Only) ..... |  |
| <b>FQ24655-56</b>             | Quarter R-L (Mexico Only) .....                    |  |
| <b>FV24602-03<sup>c</sup></b> | Vent F/R-L (Encap) (Mexico Only) .....             |  |
| <b>FB24606<sup>c</sup></b>    | Back Window (Heated) (Mexico Only) .....           |  |

<sup>a</sup> Urethane,Dam,Primer - 2 Tubes  
<sup>b</sup> Fast-Cure Urethane/Dam/Primer - Quantity 2  
<sup>c</sup> Urethane,Dam,Primer - 1.5 Tubes

**Journey 4 Door Utility ..... 2009-2011**

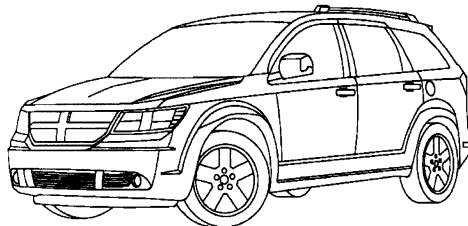

|                               |   |                  |
|-------------------------------|---|------------------|
| <b>DW01880<sup>a b</sup></b>  | Windshield (W/Third Visor Frit) (11) .....    | <b>36.5x61.0</b> |
| <b>DW01759<sup>a b</sup></b>  | Windshield (W/Third Visor Frit) (09-10) ..... | <b>36.5x61.0</b> |
| <b>DD11553-54</b>             | Door F/R-L (2 Holes) .....                    | <b>23.3x37.3</b> |
| <b>DD11555-56</b>             | Door R/R-L (2 Holes)(Solar) .....             | <b>23.5x31.3</b> |
| <b>DQ11557-58<sup>d</sup></b> | Quarter R-L (Encap)(Solar) .....              | <b>16.2x26.5</b> |
| <b>DB11559<sup>c</sup></b>    | Back Window (Heated)(Solar) .....             | <b>21.5x54.0</b> |

<sup>a</sup> Urethane,Dam,Primer - 2 Tubes  
<sup>b</sup> Fast-Cure Urethane/Dam/Primer - Quantity 2  
<sup>c</sup> Urethane,Dam,Primer - 1.5 Tubes  
<sup>d</sup> Urethane,Dam,Primer - 1 Tube

**Magnum 4 Door Station Wagon..... 2006-2008**

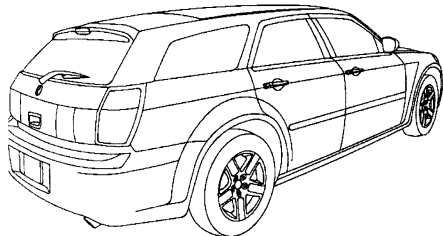

|                               |   |                  |
|-------------------------------|---|------------------|
| <b>DW01660<sup>a b</sup></b>  | Windshield (Rain Sensor) (From 01/17/2006) .....    | <b>35.5x65.5</b> |
| <b>DW01572<sup>a b</sup></b>  | Windshield (Rain Sensor) (To 01/17/2006) (06) ..... | <b>35.5x65.5</b> |
| <b>DW01571<sup>a b</sup></b>  | Windshield .....                                    | <b>35.5x65.5</b> |
| <b>DD10705-06</b>             | Door F/R-L (Solar) .....                            | <b>27.5x32.5</b> |
| <b>DD10707-08</b>             | Door R/R-L (Solar) .....                            | <b>21.5x30.5</b> |
| <b>DQ10892-93<sup>d</sup></b> | Quarter R-L (Solar) (E-Mark) .....                  | <b>11.5x32.5</b> |
| <b>DQ10710-11<sup>d</sup></b> | Quarter R-L (Solar) .....                           | <b>11.5x32.5</b> |
| <b>DB11487<sup>c</sup></b>    | Back Window (Heated)(Solar) (08) .....              | <b>17.5x51.5</b> |
| <b>DB10712<sup>c</sup></b>    | Back Window (Ant)(Heated)(Solar) (06-07) .....      | <b>17.5x51.5</b> |

<sup>a</sup> Urethane,Dam,Primer - 2 Tubes  
<sup>b</sup> Fast-Cure Urethane/Dam/Primer - Quantity 2

**Magnum (cont.)**  
<sup>c</sup> Urethane,Dam,Primer - 1.5 Tubes  
<sup>d</sup> Urethane,Dam,Primer - 1 Tube

**Nitro 4 Door Utility ..... 2007-2011**

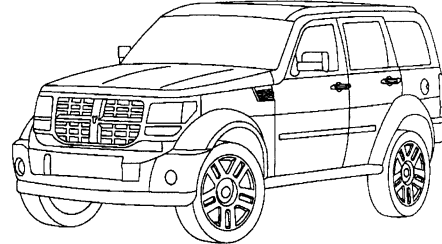

|                               |                                       |                  |
|-------------------------------|---------------------------------------|------------------|
| <b>DW01670<sup>a b</sup></b>  | Windshield (W/Third Visor Frit) ..... | <b>26.1x55.3</b> |
| <b>DD11222-23</b>             | Door F/R-L (1 Holes)(Solar) .....     | <b>22.0x28.0</b> |
| <b>DD11224-25</b>             | Door R/R-L (1 Holes)(Solar) .....     | <b>21.5x27.5</b> |
| <b>DQ11226-27<sup>d</sup></b> | Quarter R-L (Solar) .....             | <b>15.8x28.0</b> |
| <b>DB11228<sup>c</sup></b>    | Back Window (Heated)(Solar) .....     | <b>16.3x49.8</b> |

<sup>a</sup> Urethane,Dam,Primer - 2 Tubes  
<sup>b</sup> Fast-Cure Urethane/Dam/Primer - Quantity 2  
<sup>c</sup> Urethane,Dam,Primer - 1.5 Tubes  
<sup>d</sup> Urethane,Dam,Primer - 1 Tube

**Pickup 1500 2 Door Standard Cab ..... 2009-2011**

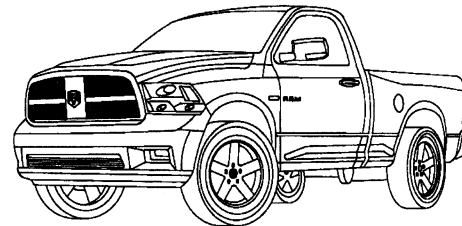

|                                  |  |                  |
|----------------------------------|--|------------------|
| <b>DW01793<sup>a b d e</sup></b> | Windshield (Solar) (W/Third Visor Frit, Aftermarket)                             | <b>33.6x64.1</b> |
| <b>DW01771<sup>a c d e</sup></b> | Windshield (Solar) (W/Third Visor Frit, Ram's Head Logo in 3rd Visor Frit) ..... | <b>33.6x64.1</b> |
| <b>DD11589-90</b>                | Door F/R-L (2 Holes) .....   | <b>25.2x38.2</b> |
| <b>DB11680</b>                   | Back Window C (Solar) (OE, Power) .....  | <b>16.5x62.0</b> |
| <b>DB11679</b>                   | Back Window C (Solar) (Manual) .....   | <b>16.5x62.5</b> |
| <b>DY90119<sup>f</sup></b>       | Back Window (Solar) (Black Frame, 3 Piece Assembly, Aftermarket, Power) .....    | <b>17.5x62.4</b> |
| <b>DY90118<sup>f</sup></b>       | Back Window (Solar) (Black Frame, 3 Piece Assembly, Aftermarket, Manual) .....   | <b>17.5x62.4</b> |
| <b>DB11828<sup>b f</sup></b>     | Back Window (Encap)(Slider)(Solar) (Aftermarket, Power, W/O Motor) .....         | <b>17.8x63.0</b> |
| <b>DB11600<sup>c f</sup></b>     | Back Window (Encap)(Slider)(Solar) (OE, Power) .....                             | <b>17.8x63.0</b> |
| <b>DB11599<sup>f</sup></b>       | Back Window (Encap)(Slider)(Solar) (OE, Manual) .....                            | <b>17.8x63.0</b> |
| <b>DB11598<sup>f</sup></b>       | Back Window (Heated)(Solar) (Stationary) .....                                   | <b>17.8x63.0</b> |
| <b>DB11597<sup>f</sup></b>       | Back Window (Solar) (Stationary) .....   | <b>17.8x63.0</b> |

<sup>a</sup> May Require Two Person Installation  
<sup>b</sup> Not On Production Vehicles  
<sup>c</sup> On Production Vehicles  
<sup>d</sup> Urethane,Dam,Primer - 2 Tubes  
<sup>e</sup> Fast-Cure Urethane/Dam/Primer - Quantity 2  
<sup>f</sup> Urethane,Dam,Primer - 1.5 Tubes



**Pickup 1500 HYBRID 2 Door Standard Cab..... 2010-2011**

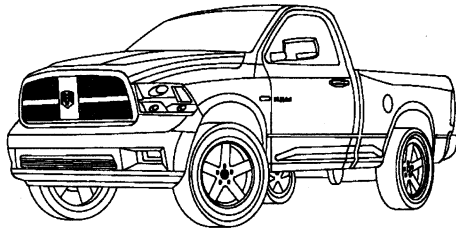

|  |                  |
|--|------------------|
| <b>DW01836<sup>a b d e</sup></b> Windshield (Solar) (W/Third Visor Frit, Acoustic Interlayer, Aftermarket) .....                       | <b>33.6x64.1</b> |
| <b>DW01830<sup>a c d e</sup></b> Windshield (Solar) (W/Third Visor Frit, Acoustic Interlayer, Ram's Head Logo in 3rd Visor Frit) ..... | <b>33.6x64.1</b> |
| <b>DD11589-90</b> Door F/R-L (2 Holes) .....   | <b>25.2x38.2</b> |
| <b>DB11680</b> Back Window C (Solar) (OE, Power) .....   | <b>16.5x62.0</b> |
| <b>DB11679</b> Back Window C (Solar) (Manual) .....  | <b>16.5x62.5</b> |
| <b>DY90119<sup>f</sup></b> Back Window (Solar) (Black Frame, 3 Piece Assembly, Aftermarket, Power) .....                               | <b>17.5x62.4</b> |
| <b>DY90118<sup>f</sup></b> Back Window (Solar) (Black Frame, 3 Piece Assembly, Aftermarket, Manual) .....                              | <b>17.5x62.4</b> |
| <b>DB11828<sup>b f</sup></b> Back Window (Encap)(Slider)(Solar) (Aftermarket, Power, W/O Motor) .....                                  | <b>17.8x63.0</b> |
| <b>DB11600<sup>c f</sup></b> Back Window (Encap)(Slider)(Solar) (OE, Power) .....  | <b>17.8x63.0</b> |
| <b>DB11599<sup>f</sup></b> Back Window (Encap)(Slider)(Solar) (OE, Manual) .....   | <b>17.8x63.0</b> |
| <b>DB11598<sup>f</sup></b> Back Window (Heated)(Solar) (Stationary) .....  | <b>17.8x63.0</b> |
| <b>DB11597<sup>f</sup></b> Back Window (Solar) (Stationary) .....  | <b>17.8x63.0</b> |

<sup>a</sup> May Require Two Person Installation  
<sup>b</sup> Not On Production Vehicles  
<sup>c</sup> On Production Vehicles  
<sup>d</sup> Urethane,Dam,Primer - 2 Tubes  
<sup>e</sup> Fast-Cure Urethane/Dam/Primer - Quantity 2  
<sup>f</sup> Urethane,Dam,Primer - 1.5 Tubes

**Pickup 3500 2 Door Standard Cab ..... 2010-2011**  
**Pickup 2500 2 Door Standard Cab ..... 2010-2011**

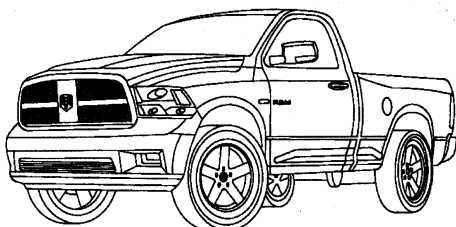

|   |                  |
|---|------------------|
| <b>DW01793<sup>a b d e</sup></b> Windshield (Solar) (W/Third Visor Frit, Aftermarket) .....                       | <b>33.6x64.1</b> |
| <b>DW01771<sup>a c d e</sup></b> Windshield (Solar) (W/Third Visor Frit, Ram's Head Logo in 3rd Visor Frit) ..... | <b>33.6x64.1</b> |
| <b>DD11589-90</b> Door F/R-L (2 Holes) .....  | <b>25.2x38.2</b> |
| <b>DB11680</b> Back Window C (Solar) (OE, Power) .....  | <b>16.5x62.0</b> |
| <b>DB11679</b> Back Window C (Solar) (Manual) .....   | <b>16.5x62.5</b> |
| <b>DY90119<sup>f</sup></b> Back Window (Solar) (Black Frame, 3 Piece Assembly, Aftermarket, Power) .....          | <b>17.5x62.4</b> |
| <b>DY90118<sup>f</sup></b> Back Window (Solar) (Black Frame, 3 Piece Assembly, Aftermarket, Manual) .....         | <b>17.5x62.4</b> |
| <b>DB11828<sup>b f</sup></b> Back Window (Encap)(Slider)(Solar) (Aftermarket, Power, W/O Motor) .....             | <b>17.8x63.0</b> |
| <b>DB11600<sup>c f</sup></b> Back Window (Encap)(Slider)(Solar) (OE, Power) .....                                 | <b>17.8x63.0</b> |
| <b>DB11599<sup>f</sup></b> Back Window (Encap)(Slider)(Solar) (OE, Manual) .....                                  | <b>17.8x63.0</b> |
| <b>DB11598<sup>f</sup></b> Back Window (Heated)(Solar) (Stationary) .....   | <b>17.8x63.0</b> |
| <b>DB11597<sup>f</sup></b> Back Window (Solar) (Stationary) .....   | <b>17.8x63.0</b> |

<sup>a</sup> May Require Two Person Installation  
<sup>b</sup> Not On Production Vehicles  
<sup>c</sup> On Production Vehicles  
<sup>d</sup> Urethane,Dam,Primer - 2 Tubes  
<sup>e</sup> Fast-Cure Urethane/Dam/Primer - Quantity 2

**Pickup (cont.)**

<sup>f</sup> Urethane,Dam,Primer - 1.5 Tubes

**Pickup 4500 2 Door Standard Cab..... 2010-2011**  
**Pickup 5500 2 Door Standard Cab..... 2010-2011**

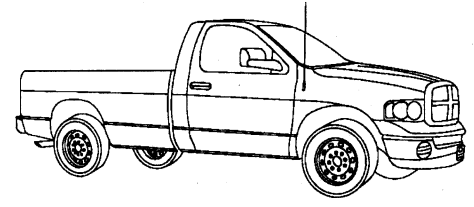

|  |                  |
|--|------------------|
| <b>DW01728<sup>a d e f</sup></b> Windshield (OE, Ram's Head Logo in 3rd Visor Frit, Black Logo) .....                    | <b>39.0x68.0</b> |
| <b>DW01669<sup>a b e f</sup></b> Windshield (Clear Logo, Ram's Head Logo in 3rd Visor Frit) .....                        | <b>39.0x68.0</b> |
| <b>DW01512<sup>a c e f</sup></b> Windshield (W/Third Visor Frit) .....   | <b>39.0x68.0</b> |
| <b>DD10071-72</b> Door F/R-L .....   | <b>27.0x36.0</b> |
| <b>DB10996</b> Back Window C (Solar) (OE, Power) .....   | <b>16.0x16.0</b> |
| <b>DB10995</b> Back Window C (Solar) (OE, Movable) .....   | <b>16.0x16.0</b> |
| <b>DY90113<sup>e</sup></b> Back Window (Slider)(Solar) (Aftermarket, 1 Panel Flush Fit, Manual) .....                    | <b>19.4x65.5</b> |
| <b>DY90104<sup>e</sup></b> Back Window (Encap)(Slider)(Solar) (Black Frame, 3 Piece Assembly, Aftermarket, Power) .....  | <b>19.4x65.5</b> |
| <b>DY90103<sup>e</sup></b> Back Window (Encap)(Slider)(Solar) (Black Frame, 3 Piece Assembly, Aftermarket, Manual) ..... | <b>19.4x65.5</b> |
| <b>DY90102<sup>e</sup></b> Back Window (Encap)(Slider) (Black Frame, 3 Piece Assembly, Aftermarket, Manual) .....        | <b>19.4x65.5</b> |
| <b>DB10941<sup>e</sup></b> Back Window (Encap)(Slider)(Solar) (OE, Power) .....  | <b>19.4x65.5</b> |
| <b>DB10940<sup>e</sup></b> Back Window (Encap)(Slider)(Solar) (OE, Manual) ..  | <b>19.4x65.5</b> |
| <b>DB10533<sup>e</sup></b> Back Window (Encap)(Heated)(Solar) (Stationary) ..  | <b>17.5x64.5</b> |
| <b>DB10077<sup>e</sup></b> Back Window (Encap)(Solar) (Stationary) .....   | <b>17.5x64.5</b> |

<sup>a</sup> May Require Two Person Installation  
<sup>b</sup> Not On Production Vehicles  
<sup>c</sup> Not On Production Vehicles 2008-2009  
<sup>d</sup> On Production Vehicles 2008-2009  
<sup>e</sup> Urethane,Dam,Primer - 2 Tubes  
<sup>f</sup> Fast-Cure Urethane/Dam/Primer - Quantity 2

**Pickup 5500 2 Door Standard Cab..... 2008-2009**  
**Pickup 4500 2 Door Standard Cab..... 2008-2009**  
**Pickup 2500 2 Door Standard Cab..... 2008-2009**  
**Pickup 3500 2 Door Standard Cab..... 2008-2009**

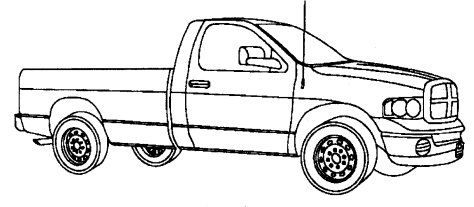

|   |                  |
|---|------------------|
| <b>DW01728<sup>a d e f</sup></b> Windshield (OE, Ram's Head Logo in 3rd Visor Frit, Black Logo) ..... | <b>39.0x68.0</b> |
| <b>DW01669<sup>a b e f</sup></b> Windshield (Clear Logo, Ram's Head Logo in 3rd Visor Frit) .....     | <b>39.0x68.0</b> |
| <b>DW01512<sup>a c e f</sup></b> Windshield (W/Third Visor Frit) .....                                | <b>39.0x68.0</b> |
| <b>DD10071-72</b> Door F/R-L .....  | <b>27.0x36.0</b> |
| <b>DB10996</b> Back Window C (Solar) (OE, Power) .....  | <b>16.0x16.0</b> |
| <b>DB10995</b> Back Window C (Solar) (OE, Movable) .....  | <b>16.0x16.0</b> |
| <b>DY90113<sup>e</sup></b> Back Window (Slider)(Solar) (Aftermarket, 1 Panel Flush Fit, Manual) ..... | <b>19.4x65.5</b> |

**Pickup (cont.)**

|                      |   |           |
|----------------------|---|-----------|
| DY90104 <sup>e</sup> | Back Window (Encap)(Slider)(Solar) (Black Frame, 3 Piece Assembly, Aftermarket, Power) .....  | 19.4x65.5 |
| DY90103 <sup>e</sup> | Back Window (Encap)(Slider)(Solar) (Black Frame, 3 Piece Assembly, Aftermarket, Manual) ..... | 19.4x65.5 |
| DY90102 <sup>e</sup> | Back Window (Encap)(Slider) (Black Frame, 3 Piece Assembly, Aftermarket, Manual) .....        | 19.4x65.5 |
| DB10941 <sup>e</sup> | Back Window (Encap)(Slider)(Solar) (OE, Power) .....  | 19.4x65.5 |
| DB10940 <sup>e</sup> | Back Window (Encap)(Slider)(Solar) (OE, Manual) ...   | 19.4x65.5 |
| DB10533 <sup>e</sup> | Back Window (Encap)(Heated)(Solar) (Stationary) ....  | 17.5x64.5 |
| DB10077 <sup>e</sup> | Back Window (Encap)(Solar) (Stationary) .....   | 17.5x64.5 |

<sup>a</sup> May Require Two Person Installation  
<sup>b</sup> Not On Production Vehicles  
<sup>c</sup> Not On Production Vehicles 2008-2009  
<sup>d</sup> On Production Vehicles 2008-2009  
<sup>e</sup> Urethane,Dam,Primer - 2 Tubes  
<sup>f</sup> Fast-Cure Urethane/Dam/Primer - Quantity 2

**Pickup 1500 2 Door Standard Cab ..... 2008**

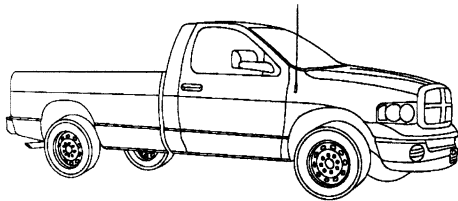

|                            |   |           |
|----------------------------|---|-----------|
| DW01728 <sup>a d e f</sup> | Windshield (OE, Ram's Head Logo in 3rd Visor Frit, Black Logo) .....                          | 39.0x68.0 |
| DW01669 <sup>a c e f</sup> | Windshield (Clear Logo, Ram's Head Logo in 3rd Visor Frit) .....                              | 39.0x68.0 |
| DW01512 <sup>a b e f</sup> | Windshield (W/Third Visor Frit) .....   | 39.0x68.0 |
| DD10071-72                 | Door F/R-L .....  | 27.0x36.0 |
| DB10996                    | Back Window C (Solar) (OE, Power) .....   | 16.0x16.0 |
| DB10995                    | Back Window C (Solar) (OE, Movable) .....   | 16.0x16.0 |
| DY90113 <sup>e</sup>       | Back Window (Slider)(Solar) (Aftermarket, 1 Panel Flush Fit, Manual) .....                    | 19.4x65.5 |
| DY90104 <sup>e</sup>       | Back Window (Encap)(Slider)(Solar) (Black Frame, 3 Piece Assembly, Aftermarket, Power) .....  | 19.4x65.5 |
| DY90103 <sup>e</sup>       | Back Window (Encap)(Slider)(Solar) (Black Frame, 3 Piece Assembly, Aftermarket, Manual) ..... | 19.4x65.5 |
| DY90102 <sup>e</sup>       | Back Window (Encap)(Slider) (Black Frame, 3 Piece Assembly, Aftermarket, Manual) .....        | 19.4x65.5 |
| DB10941 <sup>e</sup>       | Back Window (Encap)(Slider)(Solar) (OE, Power) .....  | 19.4x65.5 |
| DB10940 <sup>e</sup>       | Back Window (Encap)(Slider)(Solar) (OE, Manual) ...   | 19.4x65.5 |
| DB10533 <sup>e</sup>       | Back Window (Encap)(Heated)(Solar) (Stationary) ....  | 17.5x64.5 |
| DB10077 <sup>e</sup>       | Back Window (Encap)(Solar) (Stationary) .....   | 17.5x64.5 |

<sup>a</sup> May Require Two Person Installation  
<sup>b</sup> Not On Production Vehicles 2008 Only  
<sup>c</sup> Not On Production Vehicles  
<sup>d</sup> On Production Vehicles 2008 Only  
<sup>e</sup> Urethane,Dam,Primer - 2 Tubes  
<sup>f</sup> Fast-Cure Urethane/Dam/Primer - Quantity 2

|  |                  |
|--|------------------|
| <b>Pickup 2500 2 Door Standard Cab .....</b> | <b>2006-2007</b> |
| <b>Pickup 1500 2 Door Standard Cab .....</b> | <b>2006-2007</b> |
| <b>Pickup 3500 2 Door Standard Cab .....</b> | <b>2006-2007</b> |

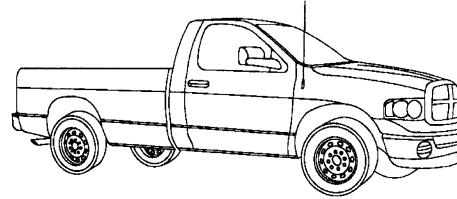

|                              |   |           |
|------------------------------|---|-----------|
| DW01728 <sup>a b f g</sup>   | Windshield (OE, Ram's Head Logo in 3rd Visor Frit, Black Logo) (From 05/01/2007) .....        | 39.0x68.0 |
| DW01669 <sup>a c e f g</sup> | Windshield (Clear Logo, Ram's Head Logo in 3rd Visor Frit) .....                              | 39.0x68.0 |
| DW01512 <sup>a d f g</sup>   | Windshield (W/Third Visor Frit) (To 05/01/2007) ....  | 39.0x68.0 |
| DW01456 <sup>a b f g</sup>   | Windshield (To 05/01/2007) .....  | 39.0x68.0 |
| DD10071-72                   | Door F/R-L .....  | 27.0x36.0 |
| DB10996                      | Back Window C (Solar) (OE, Power) .....   | 16.0x16.0 |
| DB10995                      | Back Window C (Solar) (OE, Movable) .....   | 16.0x16.0 |
| DY90113 <sup>f</sup>         | Back Window (Slider)(Solar) (Aftermarket, 1 Panel Flush Fit, Manual) .....                    | 19.4x65.5 |
| DY90104 <sup>f</sup>         | Back Window (Encap)(Slider)(Solar) (Black Frame, 3 Piece Assembly, Aftermarket, Power) .....  | 19.4x65.5 |
| DY90103 <sup>f</sup>         | Back Window (Encap)(Slider)(Solar) (Black Frame, 3 Piece Assembly, Aftermarket, Manual) ..... | 19.4x65.5 |
| DY90102 <sup>f</sup>         | Back Window (Encap)(Slider) (Black Frame, 3 Piece Assembly, Aftermarket, Manual) .....        | 19.4x65.5 |
| DB10941 <sup>f</sup>         | Back Window (Encap)(Slider)(Solar) (OE, Power) ....   | 19.4x65.5 |
| DB10940 <sup>f</sup>         | Back Window (Encap)(Slider)(Solar) (OE, Manual) ..  | 19.4x65.5 |
| DB10545 <sup>f</sup>         | Back Window (Encap) (Stationary) (06) .....   | 17.5x64.5 |
| DB10533 <sup>f</sup>         | Back Window (Encap)(Heated)(Solar) (Stationary) ...   | 17.5x64.5 |
| DB10077 <sup>e f</sup>       | Back Window (Encap)(Solar) (Stationary) .....   | 17.5x64.5 |

<sup>a</sup> May Require Two Person Installation  
<sup>b</sup> Not On Production Vehicles 2003-2007  
<sup>c</sup> Not On Production Vehicles  
<sup>d</sup> On Production Vehicles 2003-2007  
<sup>e</sup> Not On Production Vehicles 2004-2006  
<sup>f</sup> Urethane,Dam,Primer - 2 Tubes  
<sup>g</sup> Fast-Cure Urethane/Dam/Primer - Quantity 2

**Pickup 1500 4 Door Crew Cab..... 2009-2011**

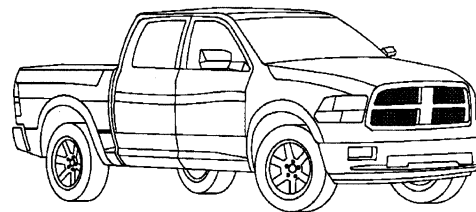

|                            |  |           |
|----------------------------|--|-----------|
| DW01793 <sup>a b d e</sup> | Windshield (Solar) (W/Third Visor Frit, Aftermarket) Logo in 3rd Visor Frit) ..... | 33.6x64.1 |
| DW01771 <sup>a c d e</sup> | Windshield (Solar) (W/Third Visor Frit, Ram's Head Logo in 3rd Visor Frit) .....   | 33.6x64.1 |
| DD11591-92                 | Door F/R-L (2 Holes) .....   | 25.3x31.4 |
| DD11595-96                 | Door R/R-L (2 Holes)(Solar) .....  | 25.2x29.2 |
| DB11680                    | Back Window C (Solar) (OE, Power) .....  | 16.5x62.0 |
| DB11679                    | Back Window C (Solar) (Manual) .....   | 16.5x62.5 |
| DY90119 <sup>f</sup>       | Back Window (Solar) (Black Frame, 3 Piece Assembly, Aftermarket, Power) .....      | 17.5x62.4 |
| DY90118 <sup>f</sup>       | Back Window (Solar) (Black Frame, 3 Piece Assembly, Aftermarket, Manual) .....     | 17.5x62.4 |
| DB11828 <sup>b f</sup>     | Back Window (Encap)(Slider)(Solar) (Aftermarket, Power, W/O Motor) .....           | 17.8x63.0 |
| DB11600 <sup>c f</sup>     | Back Window (Encap)(Slider)(Solar) (OE, Power) ....                                | 17.8x63.0 |

| Pickup  | (cont.)   |
|---|---|
| DB11599 <sup>f</sup>  | Back Window (Encap)(Slider)(Solar) (OE, Manual) ... 17.8x63.0 |
| DB11598 <sup>f</sup>  | Back Window (Heated)(Solar) (Stationary) ..... 17.8x63.0      |
| DB11597 <sup>f</sup>  | Back Window (Solar) (Stationary) ..... 17.8x63.0              |
| <sup>a</sup> May Require Two Person Installation<br><sup>b</sup> Not On Production Vehicles<br><sup>c</sup> On Production Vehicles<br><sup>d</sup> Urethane,Dam,Primer - 2 Tubes<br><sup>e</sup> Fast-Cure Urethane/Dam/Primer - Quantity 2<br><sup>f</sup> Urethane,Dam,Primer - 1.5 Tubes |   |

**Pickup 1500 HYBRID 4 Door Crew Cab ..... 2010-2011**

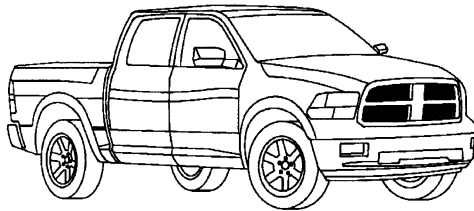

|   |   |
|---|---|
| DW01836 <sup>a b d e</sup>  | Windshield (Solar) (W/Third Visor Frit, Acoustic Interlayer, Aftermarket) ..... 33.6x64.1                       |
| DW01830 <sup>a c d e</sup>  | Windshield (Solar) (W/Third Visor Frit, Acoustic Interlayer, Ram's Head Logo in 3rd Visor Frit) ..... 33.6x64.1 |
| DD11591-92  | Door F/R-L (2 Holes) ..... 25.3x31.4  |
| DD11595-96  | Door R/R-L (2 Holes)(Solar) ..... 25.2x29.2   |
| DB11680   | Back Window C (Solar) (OE, Power) ..... 16.5x62.0   |
| DB11679   | Back Window C (Solar) (Manual) ..... 16.5x62.5  |
| DY90119 <sup>f</sup>  | Back Window (Solar) (Black Frame, 3 Piece Assembly, Aftermarket, Power) ..... 17.5x62.4                         |
| DY90118 <sup>f</sup>  | Back Window (Solar) (Black Frame, 3 Piece Assembly, Aftermarket, Manual) ..... 17.5x62.4                        |
| DB11828 <sup>b f</sup>  | Back Window (Encap)(Slider)(Solar) (Aftermarket, Power, W/O Motor) ..... 17.8x63.0                              |
| DB11600 <sup>c f</sup>  | Back Window (Encap)(Slider)(Solar) (OE, Power) ..... 17.8x63.0  |
| DB11599 <sup>f</sup>  | Back Window (Encap)(Slider)(Solar) (OE, Manual) ... 17.8x63.0   |
| DB11598 <sup>f</sup>  | Back Window (Heated)(Solar) (Stationary) ..... 17.8x63.0  |
| DB11597 <sup>f</sup>  | Back Window (Solar) (Stationary) ..... 17.8x63.0  |
| <sup>a</sup> May Require Two Person Installation<br><sup>b</sup> Not On Production Vehicles<br><sup>c</sup> On Production Vehicles<br><sup>d</sup> Urethane,Dam,Primer - 2 Tubes<br><sup>e</sup> Fast-Cure Urethane/Dam/Primer - Quantity 2<br><sup>f</sup> Urethane,Dam,Primer - 1.5 Tubes |   |

**Pickup 3500 4 Door Crew Cab ..... 2010-2011**  
**Pickup 2500 4 Door Crew Cab ..... 2010-2011**

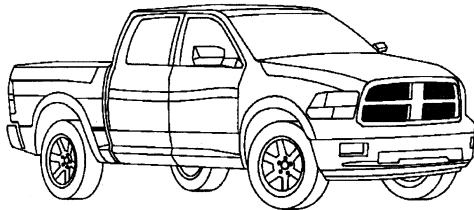

|                            |  |
|----------------------------|--|
| DW01793 <sup>a b d e</sup> | Windshield (Solar) (W/Third Visor Frit, Aftermarket) ..... 33.6x64.1                       |
| DW01771 <sup>a c d e</sup> | Windshield (Solar) (W/Third Visor Frit, Ram's Head Logo in 3rd Visor Frit) ..... 33.6x64.1 |
| DD11591-92                 | Door F/R-L (2 Holes) ..... 25.3x31.4   |
| DD11595-96                 | Door R/R-L (2 Holes)(Solar) ..... 25.2x29.2  |
| DB11680                    | Back Window C (Solar) (OE, Power) ..... 16.5x62.0  |

| Pickup                 | (cont.)  |
|------------------------|--|
| DB11679                | Back Window C (Solar) (Manual) ..... 16.5x62.5   |
| DY90119 <sup>f</sup>   | Back Window (Solar) (Black Frame, 3 Piece Assembly, Aftermarket, Power) ..... 17.5x62.4  |
| DY90118 <sup>f</sup>   | Back Window (Solar) (Black Frame, 3 Piece Assembly, Aftermarket, Manual) ..... 17.5x62.4 |
| DB11828 <sup>b f</sup> | Back Window (Encap)(Slider)(Solar) (Aftermarket, Power, W/O Motor) ..... 17.8x63.0       |
| DB11600 <sup>c f</sup> | Back Window (Encap)(Slider)(Solar) (OE, Power) .... 17.8x63.0                            |
| DB11599 <sup>f</sup>   | Back Window (Encap)(Slider)(Solar) (OE, Manual) .. 17.8x63.0                             |
| DB11598 <sup>f</sup>   | Back Window (Heated)(Solar) (Stationary) ..... 17.8x63.0                                 |
| DB11597 <sup>f</sup>   | Back Window (Solar) (Stationary) ..... 17.8x63.0   |

<sup>a</sup> May Require Two Person Installation  
<sup>b</sup> Not On Production Vehicles  
<sup>c</sup> On Production Vehicles  
<sup>d</sup> Urethane,Dam,Primer - 2 Tubes  
<sup>e</sup> Fast-Cure Urethane/Dam/Primer - Quantity 2  
<sup>f</sup> Urethane,Dam,Primer - 1.5 Tubes

**Pickup 5500 4 Door Crew Cab ..... 2010-2011**  
**Pickup 4500 4 Door Crew Cab ..... 2010-2011**

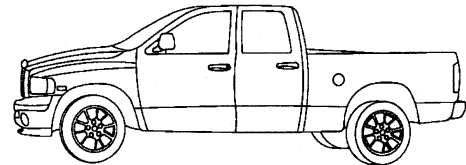

|                            |   |
|----------------------------|---|
| DW01728 <sup>a d e f</sup> | Windshield (OE, Ram's Head Logo in 3rd Visor Frit, Black Logo) ..... 39.0x68.0                          |
| DW01669 <sup>a b e f</sup> | Windshield (Clear Logo, Ram's Head Logo in 3rd Visor Frit) ..... 39.0x68.0                              |
| DW01512 <sup>c e f</sup>   | Windshield (W/Third Visor Frit) ..... 39.0x68.0   |
| DD10073-74                 | Door F/R-L ..... 27.0x32.0  |
| DD10075-76                 | Door R/R-L (Solar) ..... 23.5x27.0  |
| DB10996                    | Back Window C (Solar) (OE, Power) ..... 16.0x16.0   |
| DB10995                    | Back Window C (Solar) (OE, Movable) ..... 16.0x16.0   |
| DY90113 <sup>e</sup>       | Back Window (Slider)(Solar) (Aftermarket, 1 Panel Flush Fit, Manual) ..... 19.4x65.5                    |
| DY90104 <sup>e</sup>       | Back Window (Encap)(Slider)(Solar) (Black Frame, 3 Piece Assembly, Aftermarket, Power) ..... 19.4x65.5  |
| DY90103 <sup>e</sup>       | Back Window (Encap)(Slider)(Solar) (Black Frame, 3 Piece Assembly, Aftermarket, Manual) ..... 19.4x65.5 |
| DY90102 <sup>e</sup>       | Back Window (Encap)(Slider) (Black Frame, 3 Piece Assembly, Aftermarket, Manual) ..... 19.4x65.5        |
| DB10941 <sup>e</sup>       | Back Window (Encap)(Slider)(Solar) (OE, Power) .... 19.4x65.5   |
| DB10940 <sup>e</sup>       | Back Window (Encap)(Slider)(Solar) (OE, Manual) .. 19.4x65.5  |
| DB10533 <sup>e</sup>       | Back Window (Encap)(Heated)(Solar) (Stationary) ... 17.5x64.5   |
| DB10077 <sup>e</sup>       | Back Window (Encap)(Solar) (Stationary) ..... 17.5x64.5   |

<sup>a</sup> May Require Two Person Installation  
<sup>b</sup> Not On Production Vehicles  
<sup>c</sup> Not On Production Vehicles 2008-2009  
<sup>d</sup> On Production Vehicles 2008-2009  
<sup>e</sup> Urethane,Dam,Primer - 2 Tubes  
<sup>f</sup> Fast-Cure Urethane/Dam/Primer - Quantity 2

|  |                  |
|--|------------------|
| <b>Pickup 2500 4 Door Crew Cab</b> ..... | <b>2008-2009</b> |
| <b>Pickup 4500 4 Door Crew Cab</b> ..... | <b>2008-2009</b> |
| <b>Pickup 5500 4 Door Crew Cab</b> ..... | <b>2008-2009</b> |
| <b>Pickup 3500 4 Door Crew Cab</b> ..... | <b>2008-2009</b> |

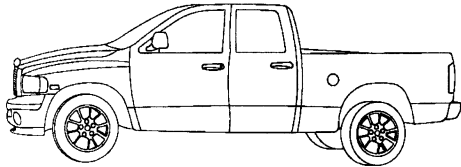

|  |           |
|--|-----------|
| DW01728 <sup>a d e f</sup> Windshield (OE, Ram's Head Logo in 3rd Visor Frit, Black Logo) .....                    | 39.0x68.0 |
| DW01669 <sup>a b e f</sup> Windshield (Clear Logo, Ram's Head Logo in 3rd Visor Frit) .....                        | 39.0x68.0 |
| DW01512 <sup>a c e f</sup> Windshield (W/Third Visor Frit) .....   | 39.0x68.0 |
| DD10073-74 Door F/R-L .....  | 27.0x32.0 |
| DD10075-76 Door R/R-L (Solar) .....  | 23.5x27.0 |
| DB10996 Back Window C (Solar) (OE, Power) .....  | 16.0x16.0 |
| DB10995 Back Window C (Solar) (OE, Movable) .....  | 16.0x16.0 |
| DY90113 <sup>e</sup> Back Window (Slider)(Solar) (Aftermarket, 1 Panel Flush Fit, Manual) .....                    | 19.4x65.5 |
| DY90104 <sup>e</sup> Back Window (Encap)(Slider)(Solar) (Black Frame, 3 Piece Assembly, Aftermarket, Power) .....  | 19.4x65.5 |
| DY90103 <sup>e</sup> Back Window (Encap)(Slider)(Solar) (Black Frame, 3 Piece Assembly, Aftermarket, Manual) ..... | 19.4x65.5 |
| DY90102 <sup>e</sup> Back Window (Encap)(Slider) (Black Frame, 3 Piece Assembly, Aftermarket, Manual) .....        | 19.4x65.5 |
| DB10941 <sup>e</sup> Back Window (Encap)(Slider)(Solar) (OE, Power) .....  | 19.4x65.5 |
| DB10940 <sup>e</sup> Back Window (Encap)(Slider)(Solar) (OE, Manual) .....   | 19.4x65.5 |
| DB10533 <sup>e</sup> Back Window (Encap)(Heated)(Solar) (Stationary) .....   | 17.5x64.5 |
| DB10077 <sup>e</sup> Back Window (Encap)(Solar) (Stationary) .....   | 17.5x64.5 |

<sup>a</sup> May Require Two Person Installation  
<sup>b</sup> Not On Production Vehicles  
<sup>c</sup> Not On Production Vehicles 2008-2009  
<sup>d</sup> On Production Vehicles 2008-2009  
<sup>e</sup> Urethane,Dam,Primer - 2 Tubes  
<sup>f</sup> Fast-Cure Urethane/Dam/Primer - Quantity 2

**Pickup 1500 4 Door Crew Cab**..... **2008**

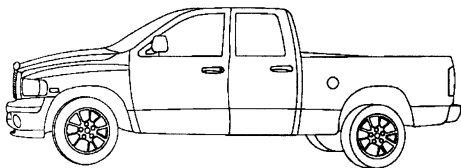

|  |           |
|--|-----------|
| DW01728 <sup>a d e f</sup> Windshield (OE, Ram's Head Logo in 3rd Visor Frit, Black Logo) .....                    | 39.0x68.0 |
| DW01669 <sup>a c e f</sup> Windshield (Clear Logo, Ram's Head Logo in 3rd Visor Frit) .....                        | 39.0x68.0 |
| DW01512 <sup>a b e f</sup> Windshield (W/Third Visor Frit) .....   | 39.0x68.0 |
| DD10073-74 Door F/R-L .....  | 27.0x32.0 |
| DD10075-76 Door R/R-L (Solar) .....  | 23.5x27.0 |
| DB10996 Back Window C (Solar) (OE, Power) .....  | 16.0x16.0 |
| DB10995 Back Window C (Solar) (OE, Movable) .....  | 16.0x16.0 |
| DY90113 <sup>e</sup> Back Window (Slider)(Solar) (Aftermarket, 1 Panel Flush Fit, Manual) .....                    | 19.4x65.5 |
| DY90104 <sup>e</sup> Back Window (Encap)(Slider)(Solar) (Black Frame, 3 Piece Assembly, Aftermarket, Power) .....  | 19.4x65.5 |
| DY90103 <sup>e</sup> Back Window (Encap)(Slider)(Solar) (Black Frame, 3 Piece Assembly, Aftermarket, Manual) ..... | 19.4x65.5 |
| DY90102 <sup>e</sup> Back Window (Encap)(Slider) (Black Frame, 3 Piece Assembly, Aftermarket, Manual) .....        | 19.4x65.5 |
| DB10941 <sup>e</sup> Back Window (Encap)(Slider)(Solar) (OE, Power) .....  | 19.4x65.5 |
| DB10940 <sup>e</sup> Back Window (Encap)(Slider)(Solar) (OE, Manual) .....   | 19.4x65.5 |

**Pickup** (cont.)

|  |           |
|--|-----------|
| DB10533 <sup>e</sup> Back Window (Encap)(Heated)(Solar) (Stationary) ... | 17.5x64.5 |
| DB10077 <sup>e</sup> Back Window (Encap)(Solar) (Stationary) .....       | 17.5x64.5 |

<sup>a</sup> May Require Two Person Installation  
<sup>b</sup> Not On Production Vehicles 2008 Only  
<sup>c</sup> Not On Production Vehicles  
<sup>d</sup> On Production Vehicles 2008 Only  
<sup>e</sup> Urethane,Dam,Primer - 2 Tubes  
<sup>f</sup> Fast-Cure Urethane/Dam/Primer - Quantity 2

|  |                  |
|--|------------------|
| <b>Pickup 1500 4 Door Crew Cab</b> ..... | <b>2006-2007</b> |
| <b>Pickup 3500 4 Door Crew Cab</b> ..... | <b>2006-2007</b> |
| <b>Pickup 2500 4 Door Crew Cab</b> ..... | <b>2006-2007</b> |

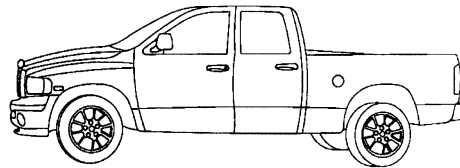

|  |           |
|--|-----------|
| DW01728 <sup>a b f g</sup> Windshield (OE, Ram's Head Logo in 3rd Visor Frit, Black Logo) (From 05/01/2007) .....  | 39.0x68.0 |
| DW01669 <sup>a c f g</sup> Windshield (Clear Logo, Ram's Head Logo in 3rd Visor Frit) .....                        | 39.0x68.0 |
| DW01512 <sup>a d f g</sup> Windshield (W/Third Visor Frit) (To 05/01/2007) .....                                   | 39.0x68.0 |
| DW01456 <sup>a b f g</sup> Windshield (To 05/01/2007) .....  | 39.0x68.0 |
| DD10934-35 Door F/R-L (Laminated, Secure Shield Logo) (To 10/15/2006) .....  | 27.0x32.0 |
| DD10073-74 Door F/R-L (From 10/15/2006) (07) .....   | 27.0x32.0 |
| DD10075-76 Door R/R-L (Solar) .....  | 23.5x27.0 |
| DB10996 Back Window C (Solar) (OE, Power) .....  | 16.0x16.0 |
| DB10995 Back Window C (Solar) (OE, Movable) .....  | 16.0x16.0 |
| DY90113 <sup>f</sup> Back Window (Slider)(Solar) (Aftermarket, 1 Panel Flush Fit, Manual) .....                    | 19.4x65.5 |
| DY90104 <sup>f</sup> Back Window (Encap)(Slider)(Solar) (Black Frame, 3 Piece Assembly, Aftermarket, Power) .....  | 19.4x65.5 |
| DY90103 <sup>f</sup> Back Window (Encap)(Slider)(Solar) (Black Frame, 3 Piece Assembly, Aftermarket, Manual) ..... | 19.4x65.5 |
| DY90102 <sup>f</sup> Back Window (Encap)(Slider) (Black Frame, 3 Piece Assembly, Aftermarket, Manual) .....        | 19.4x65.5 |
| DB10941 <sup>f</sup> Back Window (Encap)(Slider)(Solar) (OE, Power) .....  | 19.4x65.5 |
| DB10940 <sup>f</sup> Back Window (Encap)(Slider)(Solar) (OE, Manual) ..  | 19.4x65.5 |
| DB10545 <sup>f</sup> Back Window (Encap) (Stationary) (06) .....   | 17.5x64.5 |
| DB10533 <sup>f</sup> Back Window (Encap)(Heated)(Solar) (Stationary) ...   | 17.5x64.5 |
| DB10077 <sup>e f</sup> Back Window (Encap)(Solar) (Stationary) .....   | 17.5x64.5 |

<sup>a</sup> May Require Two Person Installation  
<sup>b</sup> Not On Production Vehicles 2003-2007  
<sup>c</sup> Not On Production Vehicles  
<sup>d</sup> On Production Vehicles 2003-2007  
<sup>e</sup> Not On Production Vehicles 2004-2006  
<sup>f</sup> Urethane,Dam,Primer - 2 Tubes  
<sup>g</sup> Fast-Cure Urethane/Dam/Primer - Quantity 2

|   |                  |
|---|------------------|
| <b>Pickup 3500 4 Door Extended Crew Cab</b> ..... | <b>2010-2011</b> |
| <b>Pickup 2500 4 Door Extended Crew Cab</b> ..... | <b>2010-2011</b> |

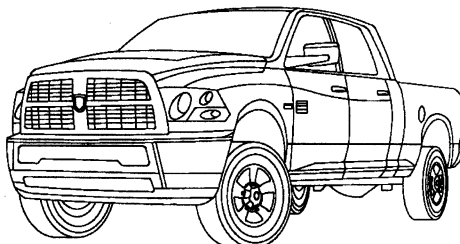

| Pickup                     | (cont.)  |           |
|----------------------------|--|-----------|
| DW01793 <sup>a b d e</sup> | Windshield (Solar) (W/Third Visor Frit, Aftermarket)                       | 33.6x64.1 |
| DW01771 <sup>a c d e</sup> | Windshield (Solar) (W/Third Visor Frit, Ram's Head Logo in 3rd Visor Frit) | 33.6x64.1 |
| DD11591-92                 | Door F/R-L (2 Holes)   | 25.3x31.4 |
| DD11595-96                 | Door R/R-L (2 Holes)(Solar)  | 25.2x29.2 |
| DB11680                    | Back Window C (Solar) (OE, Power)  | 16.5x62.0 |
| DB11679                    | Back Window C (Solar) (Manual)   | 16.5x62.5 |
| DY90119 <sup>f</sup>       | Back Window (Solar) (Black Frame, 3 Piece Assembly, Aftermarket, Power)    | 17.5x62.4 |
| DY90118 <sup>f</sup>       | Back Window (Solar) (Black Frame, 3 Piece Assembly, Aftermarket, Manual)   | 17.5x62.4 |
| DB11828 <sup>b f</sup>     | Back Window (Encap)(Slider)(Solar) (Aftermarket, Power, W/O Motor)         | 17.8x63.0 |
| DB11600 <sup>c f</sup>     | Back Window (Encap)(Slider)(Solar) (OE, Power)                             | 17.8x63.0 |
| DB11599 <sup>f</sup>       | Back Window (Encap)(Slider)(Solar) (OE, Manual)                            | 17.8x63.0 |
| DB11598 <sup>f</sup>       | Back Window (Heated)(Solar) (Stationary)                                   | 17.8x63.0 |
| DB11597 <sup>f</sup>       | Back Window (Solar) (Stationary)   | 17.8x63.0 |

**Pickup 4500 4 Door Extended Crew Cab..... 2010-2011**  
**Pickup 5500 4 Door Extended Crew Cab..... 2010-2011**

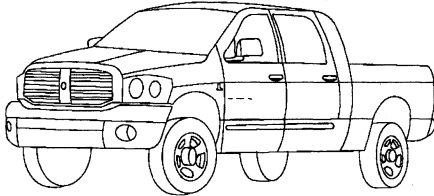

|                            |   |           |
|----------------------------|---|-----------|
| DW01728 <sup>a d e f</sup> | Windshield (OE, Ram's Head Logo in 3rd Visor Frit, Black Logo)                          | 39.0x68.0 |
| DW01669 <sup>a b e f</sup> | Windshield (Clear Logo, Ram's Head Logo in 3rd Visor Frit)                              | 39.0x68.0 |
| DW01512 <sup>a c e f</sup> | Windshield (W/Third Visor Frit)   | 39.0x68.0 |
| DD10073-74                 | Door F/R-L  | 27.0x32.0 |
| DD11323-24                 | Door R/R-L (Solar)  | 25.0x33.0 |
| DB10996                    | Back Window C (Solar) (OE, Power)   | 16.0x16.0 |
| DB10995                    | Back Window C (Solar) (OE, Movable)   | 16.0x16.0 |
| DY90113 <sup>e</sup>       | Back Window (Slider)(Solar) (Aftermarket, 1 Panel Flush Fit, Manual)                    | 19.4x65.5 |
| DY90104 <sup>e</sup>       | Back Window (Encap)(Slider)(Solar) (Black Frame, 3 Piece Assembly, Aftermarket, Power)  | 19.4x65.5 |
| DY90103 <sup>e</sup>       | Back Window (Encap)(Slider)(Solar) (Black Frame, 3 Piece Assembly, Aftermarket, Manual) | 19.4x65.5 |
| DY90102 <sup>e</sup>       | Back Window (Encap)(Slider) (Black Frame, 3 Piece Assembly, Aftermarket, Manual)        | 19.4x65.5 |
| DB10941 <sup>e</sup>       | Back Window (Encap)(Slider)(Solar) (OE, Power)  | 19.4x65.5 |
| DB10940 <sup>e</sup>       | Back Window (Encap)(Slider)(Solar) (OE, Manual)   | 19.4x65.5 |
| DB10533 <sup>e</sup>       | Back Window (Encap)(Heated)(Solar) (Stationary)   | 17.5x64.5 |
| DB10077 <sup>e</sup>       | Back Window (Encap)(Solar) (Stationary)   | 17.5x64.5 |

<sup>a</sup> May Require Two Person Installation  
<sup>b</sup> Not On Production Vehicles  
<sup>c</sup> Not On Production Vehicles 2008-2009  
<sup>d</sup> On Production Vehicles 2008-2009  
<sup>e</sup> Urethane,Dam,Primer - 2 Tubes  
<sup>f</sup> Fast-Cure Urethane/Dam/Primer - Quantity 2

|   |                  |
|---|------------------|
| <b>Pickup 3500 4 Door Extended Crew Cab .....</b> | <b>2008-2009</b> |
| <b>Pickup 2500 4 Door Extended Crew Cab .....</b> | <b>2008-2009</b> |
| <b>Pickup 5500 4 Door Extended Crew Cab .....</b> | <b>2008-2009</b> |
| <b>Pickup 4500 4 Door Extended Crew Cab .....</b> | <b>2008-2009</b> |

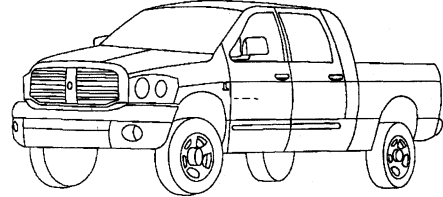

|                            |   |           |
|----------------------------|---|-----------|
| DW01728 <sup>a d e f</sup> | Windshield (OE, Ram's Head Logo in 3rd Visor Frit, Black Logo)                          | 39.0x68.0 |
| DW01669 <sup>a b e f</sup> | Windshield (Clear Logo, Ram's Head Logo in 3rd Visor Frit)                              | 39.0x68.0 |
| DW01512 <sup>a c e f</sup> | Windshield (W/Third Visor Frit)   | 39.0x68.0 |
| DD10073-74                 | Door F/R-L  | 27.0x32.0 |
| DD11323-24                 | Door R/R-L (Solar)  | 25.0x33.0 |
| DB10996                    | Back Window C (Solar) (OE, Power)   | 16.0x16.0 |
| DB10995                    | Back Window C (Solar) (OE, Movable)   | 16.0x16.0 |
| DY90113 <sup>e</sup>       | Back Window (Slider)(Solar) (Aftermarket, 1 Panel Flush Fit, Manual)                    | 19.4x65.5 |
| DY90104 <sup>e</sup>       | Back Window (Encap)(Slider)(Solar) (Black Frame, 3 Piece Assembly, Aftermarket, Power)  | 19.4x65.5 |
| DY90103 <sup>e</sup>       | Back Window (Encap)(Slider)(Solar) (Black Frame, 3 Piece Assembly, Aftermarket, Manual) | 19.4x65.5 |
| DY90102 <sup>e</sup>       | Back Window (Encap)(Slider) (Black Frame, 3 Piece Assembly, Aftermarket, Manual)        | 19.4x65.5 |
| DB10941 <sup>e</sup>       | Back Window (Encap)(Slider)(Solar) (OE, Power)  | 19.4x65.5 |
| DB10940 <sup>e</sup>       | Back Window (Encap)(Slider)(Solar) (OE, Manual)   | 19.4x65.5 |
| DB10533 <sup>e</sup>       | Back Window (Encap)(Heated)(Solar) (Stationary)   | 17.5x64.5 |
| DB10077 <sup>e</sup>       | Back Window (Encap)(Solar) (Stationary)   | 17.5x64.5 |

<sup>a</sup> May Require Two Person Installation  
<sup>b</sup> Not On Production Vehicles  
<sup>c</sup> Not On Production Vehicles 2008-2009  
<sup>d</sup> On Production Vehicles 2008-2009  
<sup>e</sup> Urethane,Dam,Primer - 2 Tubes  
<sup>f</sup> Fast-Cure Urethane/Dam/Primer - Quantity 2

**Pickup 1500 4 Door Extended Crew Cab .....** **2008**

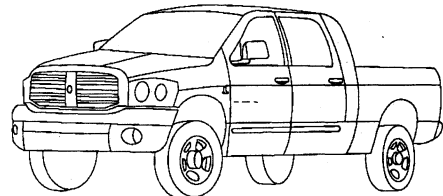

|                            |   |           |
|----------------------------|---|-----------|
| DW01728 <sup>a d e f</sup> | Windshield (OE, Ram's Head Logo in 3rd Visor Frit, Black Logo)                          | 39.0x68.0 |
| DW01669 <sup>a c e f</sup> | Windshield (Clear Logo, Ram's Head Logo in 3rd Visor Frit)                              | 39.0x68.0 |
| DW01512 <sup>a b e f</sup> | Windshield (W/Third Visor Frit)   | 39.0x68.0 |
| DD10073-74                 | Door F/R-L  | 27.0x32.0 |
| DD11323-24                 | Door R/R-L (Solar)  | 25.0x33.0 |
| DB10996                    | Back Window C (Solar) (OE, Power)   | 16.0x16.0 |
| DB10995                    | Back Window C (Solar) (OE, Movable)   | 16.0x16.0 |
| DY90113 <sup>e</sup>       | Back Window (Slider)(Solar) (Aftermarket, 1 Panel Flush Fit, Manual)                    | 19.4x65.5 |
| DY90104 <sup>e</sup>       | Back Window (Encap)(Slider)(Solar) (Black Frame, 3 Piece Assembly, Aftermarket, Power)  | 19.4x65.5 |
| DY90103 <sup>e</sup>       | Back Window (Encap)(Slider)(Solar) (Black Frame, 3 Piece Assembly, Aftermarket, Manual) | 19.4x65.5 |
| DY90102 <sup>e</sup>       | Back Window (Encap)(Slider) (Black Frame, 3 Piece Assembly, Aftermarket, Manual)        | 19.4x65.5 |

| Pickup               | (cont.)  |
|----------------------|--|
| DB10941 <sup>e</sup> | Back Window (Encap)(Slider)(Solar) (OE, Power) ..... 19.4x65.5 |
| DB10940 <sup>e</sup> | Back Window (Encap)(Slider)(Solar) (OE, Manual) ... 19.4x65.5  |
| DB10533 <sup>e</sup> | Back Window (Encap)(Heated)(Solar) (Stationary) .... 17.5x64.5 |
| DB10077 <sup>e</sup> | Back Window (Encap)(Solar) (Stationary) ..... 17.5x64.5        |

<sup>a</sup> May Require Two Person Installation  
<sup>b</sup> Not On Production Vehicles 2008 Only  
<sup>c</sup> Not On Production Vehicles  
<sup>d</sup> On Production Vehicles 2008 Only  
<sup>e</sup> Urethane,Dam,Primer - 2 Tubes  
<sup>f</sup> Fast-Cure Urethane/Dam/Primer - Quantity 2

|   |           |
|---|-----------|
| Pickup 2500 4 Door Extended Crew Cab..... | 2006-2007 |
| Pickup 3500 4 Door Extended Crew Cab..... | 2006-2007 |
| Pickup 4500 4 Door Extended Crew Cab..... | 2006-2007 |
| Pickup 5500 4 Door Extended Crew Cab..... | 2006-2007 |
| Pickup 1500 4 Door Extended Crew Cab..... | 2006-2007 |

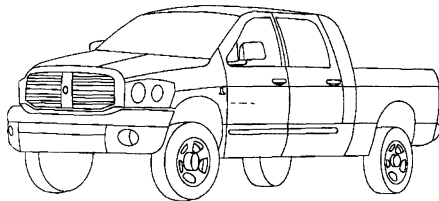

|                            |   |
|----------------------------|---|
| DW01728 <sup>a b f g</sup> | Windshield (OE, Ram's Head Logo in 3rd Visor Frit, Black Logo) (From 05/01/2007) ..... 39.0x68.0        |
| DW01669 <sup>a c f g</sup> | Windshield (Clear Logo, Ram's Head Logo in 3rd Visor Frit) ..... 39.0x68.0                              |
| DW01512 <sup>a d f g</sup> | Windshield (W/Third Visor Frit) (To 05/01/2007) ..... 39.0x68.0   |
| DW01456 <sup>a b f g</sup> | Windshield (To 05/01/2007) ..... 39.0x68.0  |
| DD10934-35                 | Door F/R-L (Laminated, Secure Shield Logo) (To 10/15/2006) ..... 27.0x32.0                              |
| DD10073-74                 | Door F/R-L (From 10/15/2006) (07) ..... 27.0x32.0   |
| DD11323-24                 | Door R/R-L (Solar) (From 10/15/2006) (07) ..... 25.0x33.0   |
| DD10938-39                 | Door R/R-L (Solar) (Laminated, Secure Shield Logo) (To 10/15/2006) ..... 24.0x32.0                      |
| DB10996                    | Back Window C (Solar) (OE, Power) ..... 16.0x16.0   |
| DB10995                    | Back Window C (Solar) (OE, Movable) ..... 16.0x16.0   |
| DY90113 <sup>f</sup>       | Back Window (Slider)(Solar) (Aftermarket, 1 Panel Flush Fit, Manual) ..... 19.4x65.5                    |
| DY90104 <sup>f</sup>       | Back Window (Encap)(Slider)(Solar) (Black Frame, 3 Piece Assembly, Aftermarket, Power) ..... 19.4x65.5  |
| DY90103 <sup>f</sup>       | Back Window (Encap)(Slider)(Solar) (Black Frame, 3 Piece Assembly, Aftermarket, Manual) ..... 19.4x65.5 |
| DY90102 <sup>f</sup>       | Back Window (Encap)(Slider) (Black Frame, 3 Piece Assembly, Aftermarket, Manual) ..... 19.4x65.5        |
| DB10941 <sup>f</sup>       | Back Window (Encap)(Slider)(Solar) (OE, Power) ..... 19.4x65.5  |
| DB10940 <sup>f</sup>       | Back Window (Encap)(Slider)(Solar) (OE, Manual) ... 19.4x65.5   |
| DB10545 <sup>f</sup>       | Back Window (Encap) (Stationary) (06) ..... 17.5x64.5   |
| DB10533 <sup>f</sup>       | Back Window (Encap)(Heated)(Solar) (Stationary) .... 17.5x64.5  |
| DB10077 <sup>e f</sup>     | Back Window (Encap)(Solar) (Stationary) ..... 17.5x64.5   |

<sup>a</sup> May Require Two Person Installation  
<sup>b</sup> Not On Production Vehicles 2003-2007  
<sup>c</sup> Not On Production Vehicles  
<sup>d</sup> On Production Vehicles 2003-2007  
<sup>e</sup> Not On Production Vehicles 2004-2006  
<sup>f</sup> Urethane,Dam,Primer - 2 Tubes  
<sup>g</sup> Fast-Cure Urethane/Dam/Primer - Quantity 2

Pickup 1500 4 Door Quad Cab..... 2009-2011

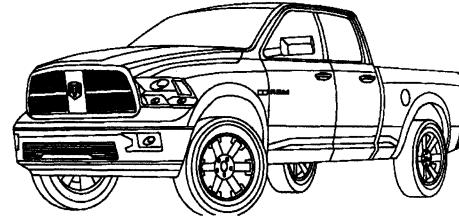

|                            |  |
|----------------------------|--|
| DW01793 <sup>a b d e</sup> | Windshield (Solar) (W/Third Visor Frit, Aftermarket) ..... 33.6x64.1                       |
| DW01771 <sup>a c d e</sup> | Windshield (Solar) (W/Third Visor Frit, Ram's Head Logo in 3rd Visor Frit) ..... 33.6x64.1 |
| DD11591-92                 | Door F/R-L (2 Holes) ..... 25.3x31.4   |
| DD11593-94                 | Door R/R-L (2 Holes)(Solar) ..... 21.5x25.5  |
| DB11680                    | Back Window C (Solar) (OE, Power) ..... 16.5x62.0  |
| DB11679                    | Back Window C (Solar) (Manual) ..... 16.5x62.5   |
| DY90119 <sup>f</sup>       | Back Window (Solar) (Black Frame, 3 Piece Assembly, Aftermarket, Power) ..... 17.5x62.4    |
| DY90118 <sup>f</sup>       | Back Window (Solar) (Black Frame, 3 Piece Assembly, Aftermarket, Manual) ..... 17.5x62.4   |
| DB11828 <sup>b f</sup>     | Back Window (Encap)(Slider)(Solar) (Aftermarket, Power, W/O Motor) ..... 17.8x63.0         |
| DB11600 <sup>e f</sup>     | Back Window (Encap)(Slider)(Solar) (OE, Power) .... 17.8x63.0                              |
| DB11599 <sup>f</sup>       | Back Window (Encap)(Slider)(Solar) (OE, Manual) .. 17.8x63.0                               |
| DB11598 <sup>f</sup>       | Back Window (Heated)(Solar) (Stationary) ..... 17.8x63.0                                   |
| DB11597 <sup>f</sup>       | Back Window (Solar) (Stationary) ..... 17.8x63.0   |

<sup>a</sup> May Require Two Person Installation  
<sup>b</sup> Not On Production Vehicles  
<sup>c</sup> On Production Vehicles  
<sup>d</sup> Urethane,Dam,Primer - 2 Tubes  
<sup>e</sup> Fast-Cure Urethane/Dam/Primer - Quantity 2  
<sup>f</sup> Urethane,Dam,Primer - 1.5 Tubes

Pickup 1500 HYBRID 4 Door Quad Cab ..... 2010-2011

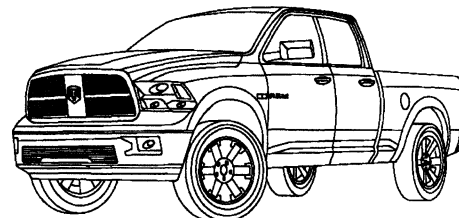

|                            |   |
|----------------------------|---|
| DW01836 <sup>a b d e</sup> | Windshield (Solar) (W/Third Visor Frit, Acoustic Interlayer, Aftermarket) ..... 33.6x64.1                       |
| DW01830 <sup>a c d e</sup> | Windshield (Solar) (W/Third Visor Frit, Acoustic Interlayer, Ram's Head Logo in 3rd Visor Frit) ..... 33.6x64.1 |
| DD11591-92                 | Door F/R-L (2 Holes) ..... 25.3x31.4  |
| DD11593-94                 | Door R/R-L (2 Holes)(Solar) ..... 21.5x25.5   |
| DB11680                    | Back Window C (Solar) (OE, Power) ..... 16.5x62.0   |
| DB11679                    | Back Window C (Solar) (Manual) ..... 16.5x62.5  |
| DY90119 <sup>f</sup>       | Back Window (Solar) (Black Frame, 3 Piece Assembly, Aftermarket, Power) ..... 17.5x62.4                         |
| DY90118 <sup>f</sup>       | Back Window (Solar) (Black Frame, 3 Piece Assembly, Aftermarket, Manual) ..... 17.5x62.4                        |
| DB11828 <sup>b f</sup>     | Back Window (Encap)(Slider)(Solar) (Aftermarket, Power, W/O Motor) ..... 17.8x63.0                              |
| DB11600 <sup>e f</sup>     | Back Window (Encap)(Slider)(Solar) (OE, Power) .... 17.8x63.0   |
| DB11599 <sup>f</sup>       | Back Window (Encap)(Slider)(Solar) (OE, Manual) .. 17.8x63.0  |
| DB11598 <sup>f</sup>       | Back Window (Heated)(Solar) (Stationary) ..... 17.8x63.0  |
| DB11597 <sup>f</sup>       | Back Window (Solar) (Stationary) ..... 17.8x63.0  |

<sup>a</sup> May Require Two Person Installation  
<sup>b</sup> Not On Production Vehicles  
<sup>c</sup> On Production Vehicles  
<sup>d</sup> Urethane,Dam,Primer - 2 Tubes  
<sup>e</sup> Fast-Cure Urethane/Dam/Primer - Quantity 2  
<sup>f</sup> Urethane,Dam,Primer - 1.5 Tubes

**SX 4 Door Sedan..... 2006-2007  
(CANADA Only)**

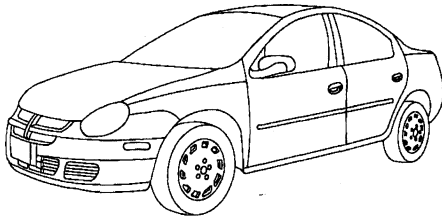

|  |                  |
|--|------------------|
| <b>DW01468<sup>a b</sup></b> Windshield (W/Third Visor Frit) ..... | <b>38.8x55.5</b> |
| <b>DW01349<sup>a b</sup></b> Windshield .....                      | <b>38.8x55.5</b> |
| <b>DD09586-87</b> Door F/R-L (2 Holes) .....                       | <b>20.1x36.2</b> |
| <b>DD09588-89</b> Door R/R-L (2 Holes) .....                       | <b>18.2x26.7</b> |
| <b>DB09590<sup>a</sup></b> Back Window (Encap)(Heated) .....       | <b>34.0x47.5</b> |
| <sup>a</sup> Urethane,Dam,Primer - 2 Tubes                         |                  |
| <sup>b</sup> Fast-Cure Urethane/Dam/Primer - Quantity 2            |                  |

**Sprinter Cutaway Van..... 2006**

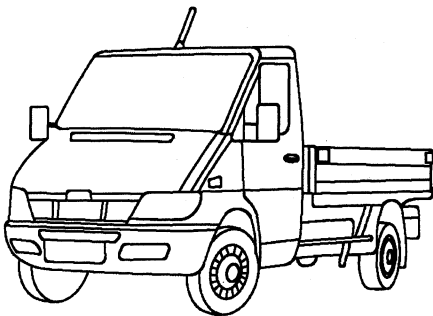

|   |                  |
|---|------------------|
| <b>DW01578<sup>a b</sup></b> Windshield (Heated)(Solar) (Heated Wiper Park Area, Rain Sensor) ..... | <b>33.0x66.0</b> |
| <b>DW01577<sup>a b</sup></b> Windshield (Solar) .....   | <b>33.0x66.0</b> |
| <b>DD10197-98</b> Door F/R-L (Solar) .....  | <b>20.0x25.0</b> |
| <b>DV10195-96</b> Vent F/R-L (Solar) .....  | <b>12.5x22.9</b> |
| <b>DB10733</b> Back Window (Solar) (Gasket Set) .....   |                  |
| <sup>a</sup> May Require Two Person Installation  |                  |
| <sup>b</sup> High Modulus Non-Conductive Urethane,Dam,Primer - 2 Tubes                              |                  |

**Sprinter 144" WB Van..... 2007-2010**

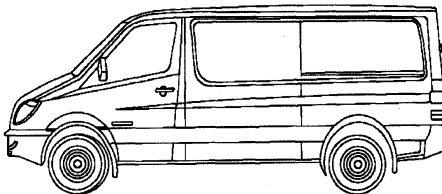

|   |                  |
|---|------------------|
| <b>DW01721<sup>a i</sup></b> Windshield (Heated)(Solar) (W/Third Visor Frit, Rain/Light Sensor, Fully Heated) ..... | <b>42.0x70.0</b> |
| <b>DW01720<sup>a i</sup></b> Windshield (Solar) (W/Third Visor Frit, Rain/Light Sensor) .....                       | <b>42.0x70.0</b> |
| <b>DW01719<sup>a i</sup></b> Windshield (Solar) (W/Third Visor Frit) .....  | <b>42.0x70.0</b> |
| <b>DD11394-95</b> Door F/R-L (Solar) .....  |                  |
| <b>DD11857<sup>b d</sup></b> Door R/R (Encap)(Solar) (Sliding Cargo Door, Aftermarket, Movable) .....               | <b>30.3x56.0</b> |
| <b>DD11396-97<sup>c h</sup></b> Door R/R-L (Solar) (Sliding Cargo Door) .....                                       | <b>30.3x56.0</b> |

**Sprinter (cont.)**

|  |                  |
|--|------------------|
| <b>DD11858<sup>b e</sup></b> Side L (Encap)(Solar) (Body Side, Aftermarket, Movable) .....                 | <b>30.3x56.0</b> |
| <b>DD11398-99<sup>c h</sup></b> Side R-L (Solar) (Body Side) .....   | <b>30.3x55.3</b> |
| <b>DQ11406-07</b> Quarter F/R-L (Solar) (W/O Sliding Cargo Door, Stationary) .....                         |                  |
| <b>DQ11404-05</b> Quarter F/R-L (Solar) (Stationary, W/Sliding Cargo Door) .....                           |                  |
| <b>DQ11410-11</b> Quarter R/R-L (Solar) (W/O Sliding Cargo Door, Movable) .....                            |                  |
| <b>DQ11408-09</b> Quarter R/R-L (Solar) (Movable, W/Sliding Cargo Door) .....                              |                  |
| <b>DQ11860<sup>b g</sup></b> Quarter L (Encap)(Solar) (W/O Sliding Cargo Door, Aftermarket, Movable) ..... | <b>30.1x64.3</b> |
| <b>DQ11859<sup>b f</sup></b> Quarter R (Encap)(Solar) (Aftermarket, Movable, W/Sliding Cargo Door) .....   | <b>27.6x64.2</b> |
| <b>DQ11402-03<sup>c</sup></b> Quarter R-L (Solar) (W/O Sliding Cargo Door, One-Piece) .....                | <b>30.3x64.5</b> |
| <b>DQ11400-01<sup>c</sup></b> Quarter R-L (Solar) (One-Piece, W/Sliding Cargo Door) .....                  | <b>27.8x64.3</b> |
| <b>DV11392-93</b> Vent F/R-L (Solar) .....   | <b>10.0x25.3</b> |
| <b>DB11420-21<sup>i</sup></b> Back Window R-L (Heated)(Solar) .....  | <b>31.5x33.0</b> |
| <b>DB11418-19<sup>j</sup></b> Back Window R-L (Solar) .....  | <b>31.5x33.0</b> |

- <sup>a</sup> May Require Two Person Installation
- <sup>b</sup> Not On Production Vehicles
- <sup>c</sup> On Production Vehicles
- <sup>d</sup> Movable Aftermarket
- <sup>e</sup> Movable Aftermarket Replacement for DD11399
- <sup>f</sup> Movable Aftermarket Replacement for DD11400
- <sup>g</sup> Movable Aftermarket Replacement for DD11403
- <sup>h</sup> High Modulus Non-Conductive Urethane,Dam,Primer - 2 Tubes
- <sup>i</sup> High Modulus Non-Conductive Urethane,Dam,Primer - 2.5 Tubes
- <sup>j</sup> High Modulus Non-Conductive Urethane,Dam,Primer - 1.5 Tubes

**Sprinter 170" WB Van..... 2007-2010**

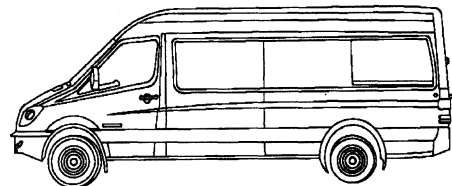

|   |                  |
|---|------------------|
| <b>DW01721<sup>a k</sup></b> Windshield (Heated)(Solar) (W/Third Visor Frit, Rain/Light Sensor, Fully Heated) ..... | <b>42.0x70.0</b> |
| <b>DW01720<sup>a k</sup></b> Windshield (Solar) (W/Third Visor Frit, Rain/Light Sensor) .....                       | <b>42.0x70.0</b> |
| <b>DW01719<sup>a k</sup></b> Windshield (Solar) (W/Third Visor Frit) .....  | <b>42.0x70.0</b> |
| <b>DD11394-95</b> Door F/R-L (Solar) .....  |                  |
| <b>DD11857<sup>b d</sup></b> Door R/R (Encap)(Solar) (Sliding Cargo Door, Aftermarket, Movable) .....               | <b>30.3x56.0</b> |
| <b>DD11396-97<sup>c j</sup></b> Door R/R-L (Solar) (Sliding Cargo Door) .....                                       | <b>30.3x56.0</b> |
| <b>DD11858<sup>b e</sup></b> Side L (Encap)(Solar) (Body Side, Aftermarket, Movable) .....                          | <b>30.3x56.0</b> |
| <b>DD11398-99<sup>c j</sup></b> Side R-L (Solar) (Body Side) .....  | <b>30.3x55.3</b> |
| <b>DQ11862<sup>b g</sup></b> Quarter F/L (Encap)(Solar) (W/O Sliding Cargo Door, Aftermarket, Movable) .....        | <b>30.3x55.8</b> |
| <b>DQ11861<sup>b f</sup></b> Quarter F/R (Encap)(Solar) (Aftermarket, Movable, W/Sliding Cargo Door) .....          | <b>30.3x55.3</b> |
| <b>DQ11414-15<sup>c</sup></b> Quarter F/R-L (Solar) (W/O Sliding Cargo Door) .....                                  | <b>30.3x56.0</b> |
| <b>DQ11412-13<sup>c</sup></b> Quarter F/R-L (Solar) (W/Sliding Cargo Door) .....                                    | <b>27.8x55.8</b> |
| <b>DQ11864<sup>b i</sup></b> Quarter R/L (Encap)(Solar) (Aftermarket, Movable) ..                                   | <b>29.6x49.0</b> |
| <b>DQ11863<sup>b h</sup></b> Quarter R/R (Encap)(Solar) (Aftermarket, Movable) ..                                   | <b>29.6x52.8</b> |
| <b>DQ11416-17<sup>c</sup></b> Quarter R/R-L (Solar) .....   | <b>30.3x49.5</b> |
| <b>DV11392-93</b> Vent F/R-L (Solar) .....  | <b>10.0x25.3</b> |
| <b>DB11420-21<sup>i</sup></b> Back Window R-L (Heated)(Solar) .....   | <b>31.5x33.0</b> |
| <b>DB11418-19<sup>j</sup></b> Back Window R-L (Solar) .....   | <b>31.5x33.0</b> |

- <sup>a</sup> May Require Two Person Installation
- <sup>b</sup> Not On Production Vehicles
- <sup>c</sup> On Production Vehicles

**Sprinter (cont.)**

<sup>d</sup> Movable Aftermarket  
<sup>e</sup> Movable Aftermarket Replacement for DD11399  
<sup>f</sup> Movable Aftermarket Replacement for DD11412  
<sup>g</sup> Movable Aftermarket Replacement for DD11415  
<sup>h</sup> Movable Aftermarket Replacement for DD11416  
<sup>i</sup> Movable Aftermarket Replacement for DD11417  
<sup>j</sup> High Modulus Non-Conductive Urethane,Dam,Primer - 2 Tubes  
<sup>k</sup> High Modulus Non-Conductive Urethane,Dam,Primer - 2.5 Tubes  
<sup>l</sup> High Modulus Non-Conductive Urethane,Dam,Primer - 1.5 Tubes

**Sprinter 118WB Van ..... 2006**

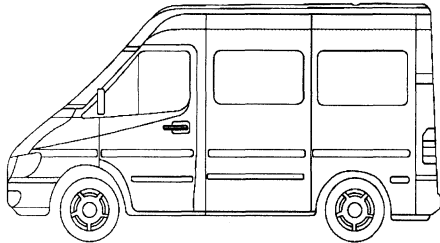

|                        |  |           |
|------------------------|--|-----------|
| DW01573 <sup>a b</sup> | Windshield (Heated)(Solar) (Heated Wiper Park Area, Rain Sensor) ..... | 34.0x66.0 |
| DW01488 <sup>a b</sup> | Windshield (Solar) .....   | 34.0x66.0 |
| DD10197-98             | Door F/R-L (Solar) .....   | 20.0x25.0 |
| DD10741                | Door M/L (Solar) (Movable, Two-Piece) .....                            |           |
| DD10739                | Door M/L (Solar) (Stationary, Two-Piece) .....                         |           |
| DD10737                | Door M/L (Solar) (Assembly, Two-Piece) .....                           |           |
| DD10740                | Door M/R (Solar) (Movable, Two-Piece) .....                            |           |
| DD10738                | Door M/R (Solar) (Stationary, Two-Piece) .....                         |           |
| DD10736                | Door M/R (Solar) (Assembly, Two-Piece) .....                           |           |
| DD10199                | Door M/R-L (Solar) (Stationary, One-Piece) .....                       | 24.2x42.0 |
| DD10744                | Side L (Solar) (Stationary, Two-Piece) .....                           |           |
| DD10743                | Side L (Solar) (Assembly, Two-Piece) .....                             |           |
| DD10742                | Side L (Solar) (Stationary, One-Piece) .....                           | 24.2x40.4 |
| DD10741                | Side L (Solar) (Movable, Two-Piece) .....                              |           |
| DD10742                | Quarter R-L (Solar) (Stationary, One-Piece) .....                      | 24.2x40.4 |
| DV10195-96             | Vent F/R-L (Solar) .....   | 12.5x22.9 |
| DB10917-18             | Back Window R-L (Heated)(Solar) (Paint Band) .....                     | 24.5x24.5 |
| DB10758-59             | Back Window R-L (Solar) (Paint Band) .....                             |           |

<sup>a</sup> May Require Two Person Installation  
<sup>b</sup> High Modulus Non-Conductive Urethane,Dam,Primer - 2 Tubes

**Sprinter 140WB Van ..... 2006**

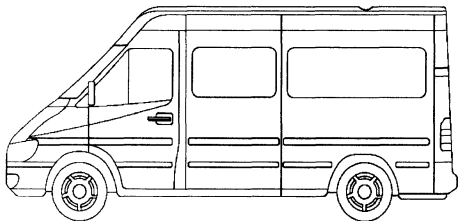

|                        |  |           |
|------------------------|--|-----------|
| DW01573 <sup>a b</sup> | Windshield (Heated)(Solar) (Heated Wiper Park Area, Rain Sensor) ..... | 34.0x66.0 |
| DW01488 <sup>a b</sup> | Windshield (Solar) .....   | 34.0x66.0 |
| DD10197-98             | Door F/R-L (Solar) .....   | 20.0x25.0 |
| DD10741                | Door M/L (Solar) (Movable, Two-Piece) .....                            |           |
| DD10739                | Door M/L (Solar) (Stationary, Two-Piece) .....                         |           |
| DD10737                | Door M/L (Solar) (Assembly, Two-Piece) .....                           |           |
| DD10740                | Door M/R (Solar) (Movable, Two-Piece) .....                            |           |
| DD10738                | Door M/R (Solar) (Stationary, Two-Piece) .....                         |           |
| DD10736                | Door M/R (Solar) (Assembly, Two-Piece) .....                           |           |
| DD10199                | Door M/R-L (Solar) (Stationary, One-Piece) .....                       | 24.2x42.0 |
| DD10744                | Side L (Solar) (Stationary, Two-Piece) .....                           |           |

**Sprinter (cont.)**

|            |  |           |
|------------|--|-----------|
| DD10743    | Side L (Solar) (Assembly, Two-Piece) .....         |           |
| DD10742    | Side L (Solar) (Stationary, One-Piece) .....       | 24.2x40.4 |
| DD10741    | Side L (Solar) (Movable, Two-Piece) .....          |           |
| DQ10201    | Quarter R-L (Solar) .....                          | 24.5x71.0 |
| DV10195-96 | Vent F/R-L (Solar) .....                           | 12.5x22.9 |
| DB10917-18 | Back Window R-L (Heated)(Solar) (Paint Band) ..... | 24.5x24.5 |
| DB10758-59 | Back Window R-L (Solar) (Paint Band) .....         |           |

<sup>a</sup> May Require Two Person Installation  
<sup>b</sup> High Modulus Non-Conductive Urethane,Dam,Primer - 2 Tubes

**Sprinter 158WB Van ..... 2006**

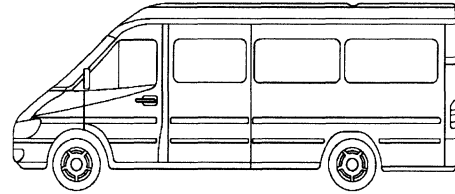

|                        |  |           |
|------------------------|--|-----------|
| DW01573 <sup>a b</sup> | Windshield (Heated)(Solar) (Heated Wiper Park Area, Rain Sensor) ..... | 34.0x66.0 |
| DW01488 <sup>a b</sup> | Windshield (Solar) .....   | 34.0x66.0 |
| DD10197-98             | Door F/R-L (Solar) .....   | 20.0x25.0 |
| DD10741                | Door M/L (Solar) (Movable, Two-Piece) .....                            |           |
| DD10739                | Door M/L (Solar) (Stationary, Two-Piece) .....                         |           |
| DD10737                | Door M/L (Solar) (Assembly, Two-Piece) .....                           |           |
| DD10740                | Door M/R (Solar) (Movable, Two-Piece) .....                            |           |
| DD10738                | Door M/R (Solar) (Stationary, Two-Piece) .....                         |           |
| DD10736                | Door M/R (Solar) (Assembly, Two-Piece) .....                           |           |
| DD10199                | Door M/R-L (Solar) (Stationary, One-Piece) .....                       | 24.2x42.0 |
| DD10744                | Side L (Solar) (Stationary, Two-Piece) .....                           |           |
| DD10743                | Side L (Solar) (Assembly, Two-Piece) .....                             |           |
| DD10742                | Side L (Solar) (Stationary, One-Piece) .....                           | 24.2x40.4 |
| DD10741                | Side L (Solar) (Movable, Two-Piece) .....                              |           |
| DQ10200                | Quarter F-R/R-L (Solar) .....  | 24.5x52.0 |
| DV10195-96             | Vent F/R-L (Solar) .....   | 12.5x22.9 |
| DB10917-18             | Back Window R-L (Heated)(Solar) (Paint Band) .....                     | 24.5x24.5 |
| DB10758-59             | Back Window R-L (Solar) (Paint Band) .....                             |           |

<sup>a</sup> May Require Two Person Installation  
<sup>b</sup> High Modulus Non-Conductive Urethane,Dam,Primer - 2 Tubes

**Stratus 2 Door Coupe ..... 2006**

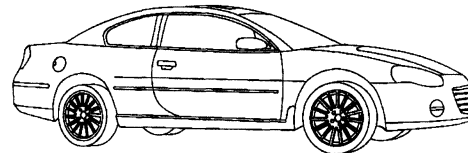

|                         |  |           |
|-------------------------|--|-----------|
| DW01516 <sup>a b</sup>  | Windshield (Electrochromic Mirror, W/Third Visor Frit) ..... | 37.0x59.4 |
| DW01515 <sup>a b</sup>  | Windshield (W/Third Visor Frit) .....                        | 37.0x59.4 |
| DD09859-60              | Door F/R-L (7 Holes) .....                                   | 22.1x41.6 |
| DQ09861-62 <sup>c</sup> | Quarter R-L (Encap) .....                                    | 14.6x30.4 |
| DB09865 <sup>a</sup>    | Back Window (Heated) .....                                   | 39.4x50.3 |

<sup>a</sup> Urethane,Dam,Primer - 2 Tubes  
<sup>b</sup> Fast-Cure Urethane/Dam/Primer - Quantity 2  
<sup>c</sup> Urethane,Dam,Primer - 1 Tube



**Stratus 4 Door Sedan..... 2006**

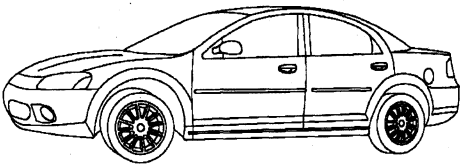

|  |                  |
|--|------------------|
| <b>DW01467<sup>a,b</sup></b> Windshield (Solar) (W/Third Visor Frit) ..... | <b>41.7x61.5</b> |
| <b>DW01413<sup>a,b</sup></b> Windshield (Solar) .....                      | <b>41.7x61.5</b> |
| <b>DD09850-51</b> Door F/R-L .....   | <b>19.7x35.7</b> |
| <b>DD09852-53</b> Door R/R-L .....   | <b>20.3x30.7</b> |
| <b>DB09854<sup>a</sup></b> Back Window (Heated) .....                      | <b>33.5x50.3</b> |

<sup>a</sup> Urethane,Dam,Primer - 2 Tubes  
<sup>b</sup> Fast-Cure Urethane/Dam/Primer - Quantity 2

**Viper 2 Door Convertible..... 2008-2011**

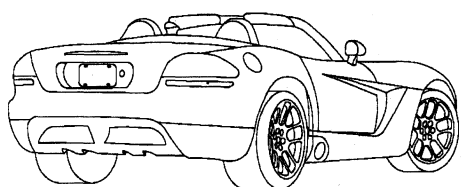

|   |                  |
|---|------------------|
| <b>DW01513<sup>a,b</sup></b> Windshield (Ant) ..... | <b>29.3x60.5</b> |
| <b>DD10331-32</b> Door F/R-L .....                  | <b>20.0x34.0</b> |
| <b>DB11081</b> Back Window (Heated) .....           | <b>26.3x45.0</b> |

<sup>a</sup> Urethane,Dam,Primer - 2 Tubes  
<sup>b</sup> Fast-Cure Urethane/Dam/Primer - Quantity 2

**Viper 2 Door Convertible..... 2006**

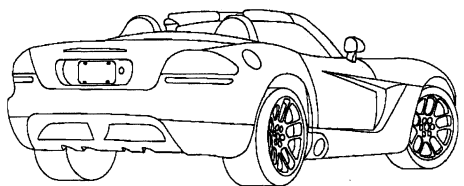

|   |                  |
|---|------------------|
| <b>DW01513<sup>a,b</sup></b> Windshield (Ant) ..... | <b>29.3x60.5</b> |
| <b>DD10331-32</b> Door F/R-L .....                  | <b>20.0x34.0</b> |
| <b>DB11081</b> Back Window (Heated) .....           | <b>26.3x45.0</b> |

<sup>a</sup> Urethane,Dam,Primer - 2 Tubes  
<sup>b</sup> Fast-Cure Urethane/Dam/Primer - Quantity 2

**Viper 2 Door Coupe..... 2008-2011**

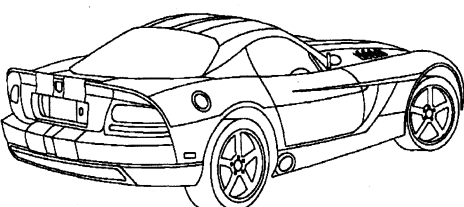

|   |                  |
|---|------------------|
| <b>DW01513<sup>a,b</sup></b> Windshield (Ant) .....   | <b>29.3x60.5</b> |
| <b>DD10992-93</b> Door F/R-L .....                    | <b>16.0x28.5</b> |
| <b>DB10994<sup>a</sup></b> Back Window (Heated) ..... | <b>38.0x53.0</b> |

**Viper (cont.)**

<sup>a</sup> Urethane,Dam,Primer - 2 Tubes  
<sup>b</sup> Fast-Cure Urethane/Dam/Primer - Quantity 2

**Viper 2 Door Coupe..... 2006**

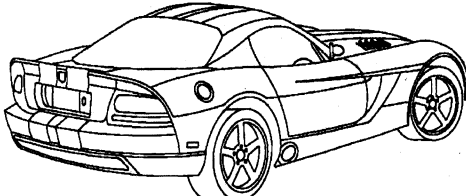

|   |                  |
|---|------------------|
| <b>DW01513<sup>a,b</sup></b> Windshield (Ant) .....   | <b>29.3x60.5</b> |
| <b>DD10992-93</b> Door F/R-L .....                    | <b>16.0x28.5</b> |
| <b>DB10994<sup>a</sup></b> Back Window (Heated) ..... | <b>38.0x53.0</b> |

<sup>a</sup> Urethane,Dam,Primer - 2 Tubes  
<sup>b</sup> Fast-Cure Urethane/Dam/Primer - Quantity 2

**500 2 Door Hatchback (MEXICO Only)..... 2009-2011**

|   |       |
|---|-------|
| <b>FW03169<sup>a,b</sup></b> Windshield (W/Third Visor Frit, Mexico Only) ..... | ..... |
| <b>FD24470-71</b> Door F/R-L (Mexico Only) .....                                | ..... |
| <b>FQ24472-73</b> Quarter R-L (Encap) (Mexico Only) .....                       | ..... |
| <b>FB24474<sup>c</sup></b> Back Window (Heated) (Mexico Only) .....             | ..... |

<sup>a</sup> Urethane,Dam,Primer - 2 Tubes  
<sup>b</sup> Fast-Cure Urethane/Dam/Primer - Quantity 2  
<sup>c</sup> Urethane,Dam,Primer - 1.5 Tubes

**Ducato Van (MEXICO Only)..... 2006-2011**

|   |       |
|---|-------|
| <b>FW03031<sup>a,b</sup></b> Windshield (Encap)(Solar) (Mexico Only, Solar Coated) .....              | ..... |
| <b>FW02929<sup>a,b</sup></b> Windshield (Encap)(Solar) (Mexico Only, Solar Coated, Rain Sensor) ..... | ..... |
| <b>FW02928<sup>a,b</sup></b> Windshield (Encap)(Solar) (Mexico Only, Rain Sensor) .....               | ..... |
| <b>FW02927<sup>a,b</sup></b> Windshield (Encap)(Solar) (Mexico Only) .....                            | ..... |
| <b>FD23797-98</b> Door F/R-L (Solar) (Mexico Only) .....  | ..... |
| <b>FD24128<sup>c</sup></b> Door R/R-L (Solar) (Mexico Only) (06-08) .....                             | ..... |
| <b>FQ24129-30<sup>c</sup></b> Quarter R-L (Solar) (Mexico Only) (06-08) .....                         | ..... |
| <b>FV23795-96</b> Vent F/R-L (Solar) (Mexico Only) .....  | ..... |
| <b>FB24131-32<sup>c</sup></b> Back Window R-L (Heated)(Solar) (Mexico Only) .....                     | ..... |

<sup>a</sup> Urethane,Dam,Primer - 2 Tubes  
<sup>b</sup> Fast-Cure Urethane/Dam/Primer - Quantity 2  
<sup>c</sup> Urethane,Dam,Primer - 1.5 Tubes

**Grande Punto 2 Door Hatchback(MEXICO Only) 2007-2010**

|   |       |
|---|-------|
| <b>FW02941<sup>a,b,d</sup></b> Windshield (Encap)(Solar) (Mexico Only, Rain Sensor) ..... | ..... |
| <b>FW02940<sup>a,b</sup></b> Windshield (Encap)(Solar) (Mexico Only) .....                | ..... |
| <b>FD23833-34</b> Door F/R-L (Solar) (Mexico Only) .....                                  | ..... |
| <b>FQ23835-36<sup>c</sup></b> Quarter R-L (Encap)(Solar) (Mexico Only) .....              | ..... |
| <b>FV23831-32</b> Vent F/R-L (Encap)(Solar) (Mexico Only) .....                           | ..... |
| <b>FB23841<sup>c</sup></b> Back Window (Heated)(1 Holes)(Solar) (Mexico Only) .....       | ..... |

<sup>a</sup> Urethane,Dam,Primer - 2 Tubes  
<sup>b</sup> Fast-Cure Urethane/Dam/Primer - Quantity 2  
<sup>c</sup> Urethane,Dam,Primer - 1.5 Tubes

**Grande Punto (cont.)**

<sup>d</sup> Rain Sensor Kit

**Grande Punto 4 Door Hatchback(MEXICO Only) 2007-2010**

- FW02941<sup>a b d</sup> Windshield (Encap)(Solar) (Mexico Only, Rain Sensor) .....
- FW02940<sup>a b</sup> Windshield (Encap)(Solar) (Mexico Only) .....
- FD23837-38 Door F/R-L (Solar) (Mexico Only) .....
- FD23839-40 Door R/R-L (Solar) (Mexico Only) .....
- FV23831-32 Vent F/R-L (Encap)(Solar) (Mexico Only) .....
- FB23841<sup>c</sup> Back Window (Heated)(1 Holes)(Solar) (Mexico Only)

<sup>a</sup> Urethane,Dam,Primer - 2 Tubes  
<sup>b</sup> Fast-Cure Urethane/Dam/Primer - Quantity 2  
<sup>c</sup> Urethane,Dam,Primer - 1.5 Tubes  
<sup>d</sup> Rain Sensor Kit

**Idea Adventure 4 Door Hatchback (MEXICO) .. 2009-2010**

- FW03158<sup>a b</sup> Windshield (W/Third Visor Frit, Mexico Only) .....
- FD24427-28 Door F/R-L (Mexico Only) .....
- FD24429-30 Door R/R-L (Mexico Only) .....
- FQ24431-32<sup>c</sup> Quarter R-L (Mexico Only) .....
- FV24425-26 Vent F/R-L (Mexico Only) .....
- FB24433<sup>c</sup> Back Window (Heated)(1 Holes) (Mexico Only) .....

<sup>a</sup> Urethane,Dam,Primer - 2 Tubes  
<sup>b</sup> Fast-Cure Urethane/Dam/Primer - Quantity 2  
<sup>c</sup> Urethane,Dam,Primer - 1.5 Tubes

**Palio 4 Door Hatchback (MEXICO Only) ..... 2006-2008**

- FW02317<sup>a b</sup> Windshield (Mexico Only) ..... 33.4x54.0
- FD23458-59 Door F/R-L (Mexico Only) .....
- FD23460-61 Door R/R-L (2 Holes) (Mexico Only) .....
- FB23467<sup>c</sup> Back Window (Heated) (Mexico Only) .....
- FB23466<sup>c</sup> Back Window (Mexico Only) .....

<sup>a</sup> Urethane,Dam,Primer - 2 Tubes  
<sup>b</sup> Fast-Cure Urethane/Dam/Primer - Quantity 2  
<sup>c</sup> Urethane,Dam,Primer - 1.5 Tubes

**Palio 4 Door Sedan (MEXICO Only) ..... 2006-2008**

- FW02317<sup>a b</sup> Windshield (Mexico Only) ..... 33.4x54.0
- FD23458-59 Door F/R-L (Mexico Only) .....
- FD23460-61 Door R/R-L (2 Holes) (Mexico Only) .....
- FB23469<sup>c</sup> Back Window (Heated) (Mexico Only) .....
- FB23468<sup>c</sup> Back Window (Mexico Only) .....

<sup>a</sup> Urethane,Dam,Primer - 2 Tubes  
<sup>b</sup> Fast-Cure Urethane/Dam/Primer - Quantity 2  
<sup>c</sup> Urethane,Dam,Primer - 1.5 Tubes

**Palio 4 Door Station Wagon (MEXICO Only)..... 2006-2011**

- FW02317<sup>a b</sup> Windshield (Mexico Only) ..... 33.4x54.0
- FD23458-59 Door F/R-L (Mexico Only) .....
- FD23460-61 Door R/R-L (2 Holes) (Mexico Only) .....
- FQ23462-63<sup>c</sup> Quarter R-L (Mexico Only) .....
- FB23464<sup>c</sup> Back Window (Heated)(1 Holes) (Mexico Only, W/ Wiper) .....

<sup>a</sup> Urethane,Dam,Primer - 2 Tubes  
<sup>b</sup> Fast-Cure Urethane/Dam/Primer - Quantity 2  
<sup>c</sup> Urethane,Dam,Primer - 1.5 Tubes

**Panda 4 Door Hatchback (MEXICO Only) ..... 2007-2011**

- FW02921<sup>a b</sup> Windshield (Solar) (Mexico Only) .....
- FD23766-67 Door F/R-L (Solar) (Mexico Only) .....
- FD23768-69 Door R/R-L (Solar) (Mexico Only) .....
- FQ23770-71<sup>c</sup> Quarter R-L (Solar) (Mexico Only) .....
- FB23772<sup>c</sup> Back Window (Heated)(1 Holes)(Solar) (Mexico Only)

<sup>a</sup> Urethane,Dam,Primer - 2 Tubes  
<sup>b</sup> Fast-Cure Urethane/Dam/Primer - Quantity 2  
<sup>c</sup> Urethane,Dam,Primer - 1.5 Tubes

**Stilo 2 Door Hatchback (MEXICO Only) ..... 2007-2009**

- FW02939<sup>a b</sup> Windshield (Encap)(Solar) (Mexico Only, Solar Coated) .....
- FW02938<sup>a b d</sup> Windshield (Encap)(Solar) (Mexico Only, Rain Sensor) .....
- FW02937<sup>a b</sup> Windshield (Encap)(Solar) (Mexico Only) .....
- FD23825-26 Door F/R-L (Solar) (Mexico Only) .....
- FQ23827-28<sup>c</sup> Quarter R-L (Encap)(Solar) (Mexico Only) .....
- FB23830<sup>c</sup> Back Window (Heated)(2 Holes)(Solar) (Mexico Only, W/Spoiler) .....
- FB23829<sup>c</sup> Back Window (Heated)(Solar) (Mexico Only) .....

<sup>a</sup> Urethane,Dam,Primer - 2 Tubes  
<sup>b</sup> Fast-Cure Urethane/Dam/Primer - Quantity 2  
<sup>c</sup> Urethane,Dam,Primer - 1.5 Tubes  
<sup>d</sup> Rain Sensor Kit

**Strada 2 Door Extended Cab (MEXICO Only) ..... 2007-2011**

- FW02317<sup>a b</sup> Windshield (Mexico Only) ..... 33.4x54.0
- FD23470-71 Door F/R-L (Mexico Only) .....
- FQ23472-73<sup>c</sup> Quarter R-L (Mexico Only) .....
- FB23474 Back Window (Encap)(Slider) (OE, Mexico Only) .....

<sup>a</sup> Urethane,Dam,Primer - 2 Tubes  
<sup>b</sup> Fast-Cure Urethane/Dam/Primer - Quantity 2  
<sup>c</sup> Urethane,Dam,Primer - 1.5 Tubes

**Strada 2 Door Standard Cab (MEXICO Only) ..... 2009-2010**

- FW02317<sup>a b</sup> Windshield (Mexico Only) ..... 33.4x54.0
- FD23470-71 Door F/R-L (Mexico Only) .....
- FB23474 Back Window (Encap)(Slider) (OE, Mexico Only) .....

<sup>a</sup> Urethane,Dam,Primer - 2 Tubes  
<sup>b</sup> Fast-Cure Urethane/Dam/Primer - Quantity 2

**Ford**

**Courier 2 Door Pickup (MEXICO Only) ..... 2006-2011**

- FW02236<sup>a b</sup> Windshield (Mexico Only) .....
- FD21300-01 Door F/R-L (Mexico Only) .....
- FB21303 Back Window (Slider) (OE, Mexico Only) ..... 15.0x48.0
- FB21302 Back Window (Stationary, Mexico Only) ..... 15.0x48.0

<sup>a</sup> Urethane,Dam,Primer - 2 Tubes  
<sup>b</sup> Fast-Cure Urethane/Dam/Primer - Quantity 2

| Crown Victoria 4 Door Sedan ..... 2006-2011   |           |
|---|-----------|
|   |           |
| DW01735 <sup>a, c, d</sup> Windshield (Solar) (W/Third Visor Frit, Aftermarket, Solar Coated) .....   | 33.1x65.0 |
| DW01506 <sup>b, c, d</sup> Windshield (Solar) (W/Third Visor Frit) .....  | 33.1x65.0 |
| DD10225-26 Door F/R-L (Solar) (Laminated) .....   | 21.9x34.7 |
| DD08626-27 Door F/R-L (2 Holes)(Solar) .....  | 23.0x34.8 |
| DD10227-28 Door R/R-L (Solar) (Laminated) .....   | 20.1x21.9 |
| DD09914-15 Door R/R-L (2 Holes)(Solar) (LWB) .....  | 23.4x26.1 |
| DD08636-37 Door R/R-L (2 Holes)(Solar) .....  | 20.2x23.0 |
| DR10797 Roof (Solar) (Assembly) .....   | 18.1x31.6 |
| DV10039-40 Vent R/R-L (Solar) (Taxi, Assembly, Police, LWB) .....   | 13.0x19.3 |
| DV08638-39 Vent R/R-L (Solar) .....   | 13.0x19.3 |
| DB10949 <sup>e</sup> Back Window (Ant)(Heated)(Solar) .....   | 23.8x61.9 |
| <sup>a</sup> Not On Production Vehicles<br><sup>b</sup> On Production Vehicles<br><sup>c</sup> Urethane, Dam, Primer - 2 Tubes<br><sup>d</sup> Fast-Cure Urethane/Dam/Primer - Quantity 2 |           |

| EcoSport 4 Door Utility (MEXICO Only)..... 2006-2011   |           |
|--|-----------|
| DW01848 <sup>a, b</sup> Windshield (W/Third Visor Frit, Mexico Only) (09-11) .....   | 36.7x55.1 |
| DW01552 <sup>a, b</sup> Windshield (Mexico Only) (06-08) .....   | 36.7x55.1 |
| DD10595-96 Door F/R-L (Mexico Only) .....  | 21.1x38.3 |
| DD10597-98 Door R/R-L (1 Holes) (Mexico Only) .....  | 21.8x26.7 |
| DQ10599-00 <sup>d</sup> Quarter R-L (Mexico Only) .....  | 17.8x22.1 |
| DB10601 <sup>c</sup> Back Window (Heated)(1 Holes) (Mexico Only) .....   | 19.1x47.6 |
| <sup>a</sup> Urethane, Dam, Primer - 2 Tubes<br><sup>b</sup> Fast-Cure Urethane/Dam/Primer - Quantity 2<br><sup>c</sup> Urethane, Dam, Primer - 1.5 Tubes<br><sup>d</sup> Urethane, Dam, Primer - 1 Tube |           |

| Econoline 3 Door Van ..... 2006-2007  |           |
|---|-----------|
|   |           |
| DW01624 <sup>a, b, c</sup> Windshield (Solar) .....   | 35.4x71.3 |
| DD09515 Door F/R (3 Holes)(Solar) (Hinged Body Side Door, Gt, Movable) .....  | 23.6x24.3 |
| DD09510 <sup>e</sup> Door F/R (4 Holes)(Solar) (Stationary, Hinged Body Side Door, Front) .....   | 23.6x24.3 |
| DD09315 Door F/R (3 Holes)(Solar) (Hinged Body Side Door, Yp, Assembly, Movable) .....  | 23.6x24.3 |
| DD09096-97 Door F/R-L (Solar) (School Bus) .....  | 25.1x29.0 |
| DD09094-95 Door F/R-L (Solar) .....   | 25.1x29.0 |
| DD09514 Door R/R (4 Holes)(Solar) (Sliding Cargo Door, Gt, Movable) .....   | 23.7x45.7 |
| DD09511 <sup>e</sup> Door R/R (4 Holes)(Solar) (Stationary, Hinged Body Side Door, Rear) .....  | 17.6x23.5 |
| DD09317 Door R/R (4 Holes)(Solar) (Sliding Cargo Door, Movable) .....   | 23.7x45.7 |
| DD09316 <sup>e</sup> Door R/R (4 Holes)(Solar) (Stationary, Hinged Body Side Door) .....  | 17.6x23.5 |
| DD09513 <sup>d</sup> Side L (4 Holes)(Solar) (Movable) .....  | 23.7x45.7 |
| DD09512 <sup>d</sup> Side L (4 Holes)(Solar) (Assembly, Gt, Movable) .....  | 23.7x45.7 |
| DD09318 <sup>d</sup> Side L (4 Holes)(Solar) (Movable) .....  | 23.7x45.7 |
| DQ11004-05 <sup>d</sup> Quarter F/R-L (Encap)(Solar) .....  | 23.3x57.5 |
| DQ11006-07 <sup>e</sup> Quarter R/R-L (Encap)(Solar) (Extended Van) .....   | 17.0x23.5 |
| DB09520-21 <sup>e</sup> Back Window R-L (4 Holes)(Solar) (Stationary) .....   | 21.8x25.3 |
| <sup>a</sup> May Require Two Person Installation<br><sup>b</sup> Urethane, Dam, Primer - 2 Tubes<br><sup>c</sup> Fast-Cure Urethane/Dam/Primer - Quantity 2<br><sup>d</sup> Foam Core Butyl Tape - Quantity 1.5<br><sup>e</sup> Foam Core Butyl Tape - Quantity 1 |           |

| Econoline (cont.)   |           |
|---|-----------|
| DD09316 <sup>e</sup> Door R/R (4 Holes)(Solar) (Stationary, Hinged Body Side Door) .....  | 17.6x23.5 |
| DD09513 <sup>d</sup> Side L (4 Holes)(Solar) (Movable) .....  | 23.7x45.7 |
| DD09512 <sup>d</sup> Side L (4 Holes)(Solar) (Assembly, Gt, Movable) .....  | 23.7x45.7 |
| DD09318 <sup>d</sup> Side L (4 Holes)(Solar) (Movable) .....  | 23.7x45.7 |
| DQ11004-05 <sup>d</sup> Quarter F/R-L (Encap)(Solar) (From 09/06/2005) .....  | 23.3x57.5 |
| DQ09516-17 <sup>d</sup> Quarter F/R-L (Encap)(Solar) (Gt) (To 09/06/2005) (06) .....  | 23.3x57.5 |
| DQ09319-20 <sup>d</sup> Quarter F/R-L (Encap)(Solar) (To 09/06/2005) (06) .....   | 23.3x57.5 |
| DQ11006-07 <sup>e</sup> Quarter R/R-L (Encap)(Solar) (Extended Van) (From 09/06/2005) (06) .....  | 17.0x23.5 |
| DQ09518-19 <sup>e</sup> Quarter R/R-L (Encap)(Solar) (Extended Van, Gt) (To 09/06/2005) (06) .....  | 17.0x23.5 |
| DQ09321-22 <sup>e</sup> Quarter R/R-L (Encap)(Solar) (Extended Van) (To 09/06/2005) (06) .....  | 17.0x23.5 |
| DB09520-21 <sup>e</sup> Back Window R-L (4 Holes)(Solar) (Stationary) .....   | 21.8x25.3 |
| <sup>a</sup> May Require Two Person Installation<br><sup>b</sup> Urethane, Dam, Primer - 2 Tubes<br><sup>c</sup> Fast-Cure Urethane/Dam/Primer - Quantity 2<br><sup>d</sup> Foam Core Butyl Tape - Quantity 1.5<br><sup>e</sup> Foam Core Butyl Tape - Quantity 1 |           |

| Econoline Extended Van ..... 2008-2011  |           |
|---|-----------|
|   |           |
| DW01767 <sup>a, b, c</sup> Windshield (Solar) (09-11) .....   | 35.4x71.3 |
| DW01624 <sup>a, b, c</sup> Windshield (Solar) (08) .....  | 35.4x71.3 |
| DD09515 Door F/R (3 Holes)(Solar) (Hinged Body Side Door, Gt, Movable) .....  | 23.6x24.3 |
| DD09510 <sup>e</sup> Door F/R (4 Holes)(Solar) (Stationary, Hinged Body Side Door, Front) .....   | 23.6x24.3 |
| DD09315 Door F/R (3 Holes)(Solar) (Hinged Body Side Door, Assembly, Movable) .....  | 23.6x24.3 |
| DD09096-97 Door F/R-L (Solar) (School Bus) .....  | 25.1x29.0 |
| DD09094-95 Door F/R-L (Solar) .....   | 25.1x29.0 |
| DD09514 Door R/R (4 Holes)(Solar) (Sliding Cargo Door, Gt, Movable) .....   | 23.7x45.7 |
| DD09511 <sup>e</sup> Door R/R (4 Holes)(Solar) (Stationary, Hinged Body Side Door, Rear) .....  | 17.6x23.5 |
| DD09317 Door R/R (4 Holes)(Solar) (Sliding Cargo Door, Movable) .....   | 23.7x45.7 |
| DD09316 <sup>e</sup> Door R/R (4 Holes)(Solar) (Stationary, Hinged Body Side Door) .....  | 17.6x23.5 |
| DD09513 <sup>d</sup> Side L (4 Holes)(Solar) (Movable) .....  | 23.7x45.7 |
| DD09512 <sup>d</sup> Side L (4 Holes)(Solar) (Assembly, Gt, Movable) .....  | 23.7x45.7 |
| DD09318 <sup>d</sup> Side L (4 Holes)(Solar) (Movable) .....  | 23.7x45.7 |
| DQ11004-05 <sup>d</sup> Quarter F/R-L (Encap)(Solar) .....  | 23.3x57.5 |
| DQ11006-07 <sup>e</sup> Quarter R/R-L (Encap)(Solar) (Extended Van) .....   | 17.0x23.5 |
| DB09520-21 <sup>e</sup> Back Window R-L (4 Holes)(Solar) (Stationary) .....   | 21.8x25.3 |
| <sup>a</sup> May Require Two Person Installation<br><sup>b</sup> Urethane, Dam, Primer - 2 Tubes<br><sup>c</sup> Fast-Cure Urethane/Dam/Primer - Quantity 2<br><sup>d</sup> Foam Core Butyl Tape - Quantity 1.5<br><sup>e</sup> Foam Core Butyl Tape - Quantity 1 |           |

**Econoline Van..... 2008-2011**

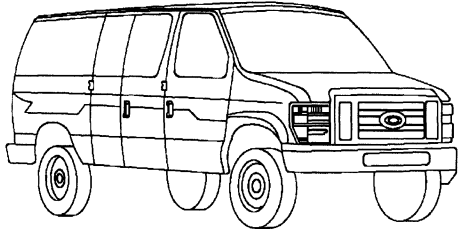

|                          |  |           |
|--------------------------|--|-----------|
| DW01767 <sup>a b c</sup> | Windshield (Solar) (09-11) .....   | 35.4x71.3 |
| DW01624 <sup>a b c</sup> | Windshield (Solar) (08) .....  | 35.4x71.3 |
| DD09515                  | Door F/R (3 Holes)(Solar) (Hinged Body Side Door, Gt, Movable) .....       | 23.6x24.3 |
| DD09510 <sup>e</sup>     | Door F/R (4 Holes)(Solar) (Stationary, Hinged Body Side Door, Front) ..... | 23.6x24.3 |
| DD09315                  | Door F/R (3 Holes)(Solar) (Hinged Body Side Door, Assembly, Movable) ..... | 23.6x24.3 |
| DD09096-97               | Door F/R-L (Solar) (School Bus) .....                                      | 25.1x29.0 |
| DD09094-95               | Door F/R-L (Solar) .....   | 25.1x29.0 |
| DD09514                  | Door R/R (4 Holes)(Solar) (Sliding Cargo Door, Gt, Movable) .....          | 23.7x45.7 |
| DD09511 <sup>e</sup>     | Door R/R (4 Holes)(Solar) (Stationary, Hinged Body Side Door, Rear) .....  | 17.6x23.5 |
| DD09317                  | Door R/R (4 Holes)(Solar) (Sliding Cargo Door, Movable) .....              | 23.7x45.7 |
| DD09316 <sup>e</sup>     | Door R/R (4 Holes)(Solar) (Stationary, Hinged Body Side Door) .....        | 17.6x23.5 |
| DD09513 <sup>d</sup>     | Side L (4 Holes)(Solar) (Movable) .....                                    | 23.7x45.7 |
| DD09512 <sup>d</sup>     | Side L (4 Holes)(Solar) (Assembly, Gt, Movable) .....                      | 23.7x45.7 |
| DD09318 <sup>d</sup>     | Side L (4 Holes)(Solar) (Movable) .....                                    | 23.7x45.7 |
| DQ11004-05 <sup>d</sup>  | Quarter F/R-L (Encap)(Solar) .....   | 23.3x57.5 |
| DB09520-21 <sup>e</sup>  | Back Window R-L (4 Holes)(Solar) (Stationary) .....                        | 21.8x25.3 |

<sup>a</sup> May Require Two Person Installation  
<sup>b</sup> Urethane,Dam,Primer - 2 Tubes  
<sup>c</sup> Fast-Cure Urethane/Dam/Primer - Quantity 2  
<sup>d</sup> Foam Core Butyl Tape - Quantity 1.5  
<sup>e</sup> Foam Core Butyl Tape - Quantity 1

**Edge 4 Door Utility..... 2011**

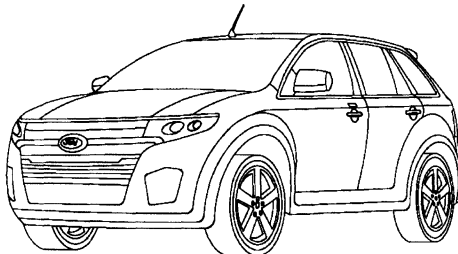

|                           |  |           |
|---------------------------|--|-----------|
| DW01845 <sup>b d e</sup>  | Windshield (Solar) (W/Third Visor Frit, Acoustic Inter-layer, Rain Sensor) ..... | 43.2x62.5 |
| DW01654 <sup>b d e</sup>  | Windshield (Solar) (W/Third Visor Frit, Acoustic Inter-layer) .....              | 43.2x62.5 |
| DW01653 <sup>d e</sup>    | Windshield (Solar) (W/Third Visor Frit) .....                                    | 43.2x62.5 |
| DD11847-48                | Door F/R-L (Solar) (Laminated, Acoustic Interlayer) ..                           | 22.3x39.0 |
| DD11136-37                | Door F/R-L (Solar) .....   | 22.3x39.0 |
| DD11140-41                | Door R/R-L (Solar) .....   | 23.0x23.5 |
| DR11712                   | Roof F (Solar) (Movable) .....   | 37.2x37.5 |
| DR11779                   | Roof R (Solar) (Stationary) .....  | 37.2x37.5 |
| DQ11424-25 <sup>a f</sup> | Quarter R-L (Encap)(Solar) (Chrome/Black Frame) ...                              | 16.3x26.3 |
| DQ11148-49 <sup>f</sup>   | Quarter R-L (Encap)(Solar) (Black Frame) .....                                   | 16.3x26.3 |
| DV11144-45                | Vent R/R-L (Solar) .....   | 10.0x17.8 |
| DB11155 <sup>d</sup>      | Back Window (Heated)(1 Holes)(Solar) .....                                       | 25.5x56.0 |

<sup>a</sup> Limited Model Only  
<sup>b</sup> On Production Vehicles

**Edge (cont.)**

<sup>c</sup> Not On Production Vehicles 2011  
<sup>d</sup> Urethane,Dam,Primer - 2 Tubes  
<sup>e</sup> Fast-Cure Urethane/Dam/Primer - Quantity 2  
<sup>f</sup> Urethane,Dam,Primer - 1 Tube

|                                       |                  |
|---------------------------------------|------------------|
| <b>Edge SE 4 Door Utility .....</b>   | <b>2009-2010</b> |
| <b>Edge SEL 4 Door Utility.....</b>   | <b>2009-2010</b> |
| <b>Edge SPORT 4 Door Utility.....</b> | <b>2009-2010</b> |

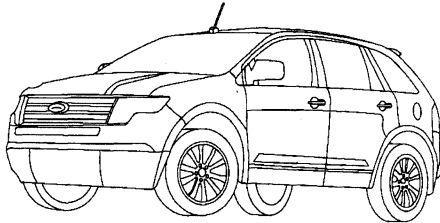

|                           |   |           |
|---------------------------|---|-----------|
| DW01653 <sup>b c</sup>    | Windshield (Solar) (W/Third Visor Frit) .....               | 43.2x62.5 |
| DD11136-37                | Door F/R-L (Solar) .....                                    | 22.3x39.0 |
| DD11140-41                | Door R/R-L (Solar) .....                                    | 23.0x23.5 |
| DD11138-39                | Door R/R-L (Solar) (Export Only) .....                      | 22.6x24.0 |
| DR11712                   | Roof F (Solar) (Movable) .....                              | 37.2x37.5 |
| DR11779                   | Roof R (Solar) (Stationary) .....                           | 37.2x37.5 |
| DQ11424-25 <sup>a d</sup> | Quarter R-L (Encap)(Solar) (Chrome/Black Frame) ..          | 16.3x26.3 |
| DQ11148-49 <sup>d</sup>   | Quarter R-L (Encap)(Solar) (Black Frame) .....              | 16.3x26.3 |
| DQ11146-47 <sup>d</sup>   | Quarter R-L (Encap)(Solar) (Black Frame, Export Only) ..... | 16.3x26.3 |
| DV11144-45                | Vent R/R-L (Solar) .....                                    | 10.0x17.8 |
| DV11142-43                | Vent R/R-L (Solar) (Export Only) .....                      | 9.4x17.6  |
| DB11155 <sup>b</sup>      | Back Window (Heated)(1 Holes)(Solar) .....                  | 25.5x56.0 |
| DB11154 <sup>b</sup>      | Back Window (Heated)(1 Holes)(Solar) (Export Only) .....    | 25.5x56.0 |

<sup>a</sup> Limited Model Only  
<sup>b</sup> Urethane,Dam,Primer - 2 Tubes  
<sup>c</sup> Fast-Cure Urethane/Dam/Primer - Quantity 2  
<sup>d</sup> Urethane,Dam,Primer - 1 Tube

**Edge LIMITED 4 Door Utility..... 2009-2010**

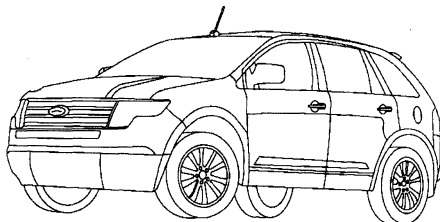

|                           |   |           |
|---------------------------|---|-----------|
| DW01654 <sup>c d e</sup>  | Windshield (Solar) (W/Third Visor Frit, Acoustic Inter-layer) ..... | 43.2x62.5 |
| DW01653 <sup>b d e</sup>  | Windshield (Solar) (W/Third Visor Frit) .....                       | 43.2x62.5 |
| DD11136-37                | Door F/R-L (Solar) .....  | 22.3x39.0 |
| DD11140-41                | Door R/R-L (Solar) .....  | 23.0x23.5 |
| DD11138-39                | Door R/R-L (Solar) (Export Only) .....                              | 22.6x24.0 |
| DR11712                   | Roof F (Solar) (Movable) .....                                      | 37.2x37.5 |
| DR11779                   | Roof R (Solar) (Stationary) .....                                   | 37.2x37.5 |
| DQ11424-25 <sup>a f</sup> | Quarter R-L (Encap)(Solar) (Chrome/Black Frame) ..                  | 16.3x26.3 |
| DQ11148-49 <sup>f</sup>   | Quarter R-L (Encap)(Solar) (Black Frame) .....                      | 16.3x26.3 |
| DQ11146-47 <sup>f</sup>   | Quarter R-L (Encap)(Solar) (Black Frame, Export Only) .....         | 16.3x26.3 |
| DV11144-45                | Vent R/R-L (Solar) .....  | 10.0x17.8 |
| DV11142-43                | Vent R/R-L (Solar) (Export Only) .....                              | 9.4x17.6  |
| DB11155 <sup>d</sup>      | Back Window (Heated)(1 Holes)(Solar) .....                          | 25.5x56.0 |

**Edge (cont.)**

|                            |  |                  |
|----------------------------|--|------------------|
| <b>DB11154<sup>d</sup></b> | Back Window (Heated)(1 Holes)(Solar) (Export Only) | <b>25.5x56.0</b> |
| <sup>a</sup>               | Limited Model Only                                 |                  |
| <sup>b</sup>               | Not On Production Vehicles                         |                  |
| <sup>c</sup>               | On Production Vehicles                             |                  |
| <sup>d</sup>               | Urethane,Dam,Primer - 2 Tubes                      |                  |
| <sup>e</sup>               | Fast-Cure Urethane/Dam/Primer - Quantity 2         |                  |
| <sup>f</sup>               | Urethane,Dam,Primer - 1 Tube                       |                  |

**Edge 4 Door Utility ..... 2007-2008**

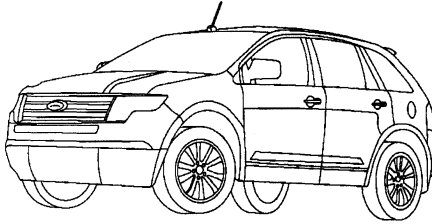

|                               |   |                  |
|-------------------------------|---|------------------|
| <b>DW01653<sup>b c</sup></b>  | Windshield (Solar) (W/Third Visor Frit)               | <b>43.2x62.5</b> |
| <b>DD11136-37</b>             | Door F/R-L (Solar)                                    | <b>22.3x39.0</b> |
| <b>DD11140-41</b>             | Door R/R-L (Solar)                                    | <b>23.0x23.5</b> |
| <b>DD11138-39</b>             | Door R/R-L (Solar) (Export Only)                      | <b>22.6x24.0</b> |
| <b>DR11712</b>                | Roof F (Solar) (Movable)                              | <b>37.2x37.5</b> |
| <b>DR11779</b>                | Roof R (Solar) (Stationary)                           |                  |
| <b>DQ11424-25<sup>d</sup></b> | Quarter R-L (Encap)(Solar) (Chrome/Black Frame) (08)  | <b>16.3x26.3</b> |
| <b>DQ11148-49<sup>d</sup></b> | Quarter R-L (Encap)(Solar) (Black Frame)              | <b>16.3x26.3</b> |
| <b>DQ11146-47<sup>d</sup></b> | Quarter R-L (Encap)(Solar) (Black Frame, Export Only) | <b>16.3x26.3</b> |
| <b>DV11144-45</b>             | Vent R/R-L (Solar)                                    | <b>10.0x17.8</b> |
| <b>DV11142-43</b>             | Vent R/R-L (Solar) (Export Only)                      | <b>9.4x17.6</b>  |
| <b>DB11155<sup>b</sup></b>    | Back Window (Heated)(1 Holes)(Solar)                  | <b>25.5x56.0</b> |
| <b>DB11154<sup>b</sup></b>    | Back Window (Heated)(1 Holes)(Solar) (Export Only)    | <b>25.5x56.0</b> |

<sup>a</sup> Limited Model Only  
<sup>b</sup> Urethane,Dam,Primer - 2 Tubes  
<sup>c</sup> Fast-Cure Urethane/Dam/Primer - Quantity 2  
<sup>d</sup> Urethane,Dam,Primer - 1 Tube

**Escape 4 Door Utility ..... 2008-2011**

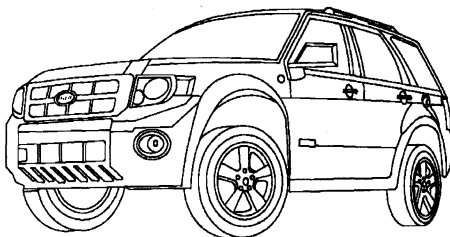

|                                |   |                  |
|--------------------------------|---|------------------|
| <b>DW01795<sup>a c d</sup></b> | Windshield (Solar) (W/Third Visor Frit, Aftermarket)          | <b>33.8x55.5</b> |
| <b>DW01684<sup>b c d</sup></b> | Windshield (Solar) (W/Third Visor Frit, Acoustic Inter-layer) | <b>33.8x55.5</b> |
| <b>DD11259-60</b>              | Door F/R-L (Solar)  | <b>21.3x32.8</b> |
| <b>DD11261-62</b>              | Door R/R-L (Solar)  | <b>19.9x28.4</b> |
| <b>DR11711</b>                 | Roof (Encap)(Solar) (09-11)                                   | <b>19.1x34.5</b> |
| <b>DR09758</b>                 | Roof (Encap)(Solar) (08)                                      | <b>19.1x34.5</b> |
| <b>DQ11263-64<sup>e</sup></b>  | Quarter R-L (Solar)   | <b>16.9x29.4</b> |
| <b>DB11913</b>                 | Back Window (Heated)(5 Holes)(Solar) (11)                     | <b>18.8x50.4</b> |
| <b>DB11266</b>                 | Back Window (Heated)(3 Holes)(Solar) (08-10)                  | <b>18.8x50.4</b> |

<sup>a</sup> Not On Production Vehicles  
<sup>b</sup> On Production Vehicles  
<sup>c</sup> Urethane,Dam,Primer - 2 Tubes  
<sup>d</sup> Fast-Cure Urethane/Dam/Primer - Quantity 2  
<sup>e</sup> Urethane,Dam,Primer - 1 Tube

**Escape HYBRID 4 Door Utility ..... 2008-2011**

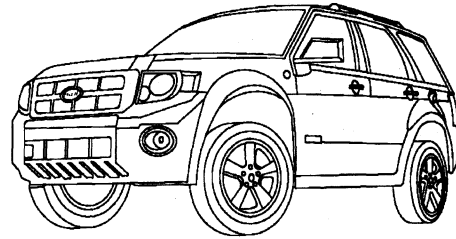

|                                |   |                  |
|--------------------------------|---|------------------|
| <b>DW01795<sup>a c d</sup></b> | Windshield (Solar) (W/Third Visor Frit, Aftermarket)          | <b>33.8x55.5</b> |
| <b>DW01684<sup>b c d</sup></b> | Windshield (Solar) (W/Third Visor Frit, Acoustic Inter-layer) | <b>33.8x55.5</b> |
| <b>DD11259-60</b>              | Door F/R-L (Solar)  | <b>21.3x32.8</b> |
| <b>DD11261-62</b>              | Door R/R-L (Solar)  | <b>19.9x28.4</b> |
| <b>DR11711</b>                 | Roof (Encap)(Solar) (09-11)                                   | <b>19.1x34.5</b> |
| <b>DR09758</b>                 | Roof (Encap)(Solar) (08)                                      | <b>19.1x34.5</b> |
| <b>DQ11265<sup>e</sup></b>     | Quarter L (Solar) (Hybrid, W/Battery Vent)                    | <b>16.9x29.4</b> |
| <b>DQ11263<sup>e</sup></b>     | Quarter R (Solar)   | <b>16.9x29.4</b> |
| <b>DB11913</b>                 | Back Window (Heated)(5 Holes)(Solar) (11)                     | <b>18.8x50.4</b> |
| <b>DB11266</b>                 | Back Window (Heated)(3 Holes)(Solar) (08-10)                  | <b>18.8x50.4</b> |

<sup>a</sup> Not On Production Vehicles  
<sup>b</sup> On Production Vehicles  
<sup>c</sup> Urethane,Dam,Primer - 2 Tubes  
<sup>d</sup> Fast-Cure Urethane/Dam/Primer - Quantity 2  
<sup>e</sup> Urethane,Dam,Primer - 1 Tube

**Escape 4 Door Utility ..... 2006-2007**

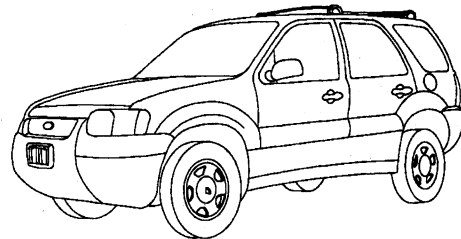

|                               |   |                  |
|-------------------------------|---|------------------|
| <b>DW01579<sup>a b</sup></b>  | Windshield (Solar) (W/Third Visor Frit) | <b>33.8x55.5</b> |
| <b>DD09751-52</b>             | Door F/R-L (2 Holes)(Solar)             | <b>21.3x33.7</b> |
| <b>DD09753-54</b>             | Door R/R-L (2 Holes)(Solar)             | <b>21.1x28.4</b> |
| <b>DR09758</b>                | Roof (Encap)(Solar)                     | <b>19.1x34.5</b> |
| <b>DQ10055-56<sup>c</sup></b> | Quarter R-L (Solar)                     | <b>18.1x29.4</b> |
| <b>DB10273</b>                | Back Window (Heated)(8 Holes)(Solar)    | <b>18.6x50.3</b> |

<sup>a</sup> Urethane,Dam,Primer - 2 Tubes  
<sup>b</sup> Fast-Cure Urethane/Dam/Primer - Quantity 2  
<sup>c</sup> Urethane,Dam,Primer - 1 Tube

**Escape HYBRID 4 Door Utility ..... 2006-2007**

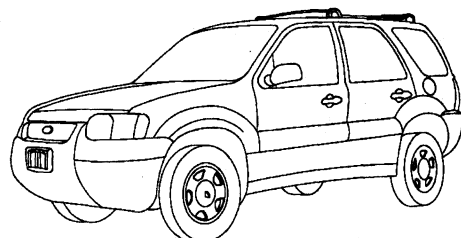

|                              |   |                  |
|------------------------------|---|------------------|
| <b>DW01579<sup>a b</sup></b> | Windshield (Solar) (W/Third Visor Frit) | <b>33.8x55.5</b> |
| <b>DD09751-52</b>            | Door F/R-L (2 Holes)(Solar)             | <b>21.3x33.7</b> |

**Escape (cont.)**

|                      |   |           |
|----------------------|---|-----------|
| DD09753-54           | Door R/R-L (2 Holes)(Solar)             | 21.1x28.4 |
| DR09758              | Roof (Encap)(Solar)                     | 19.1x34.5 |
| DQ10721 <sup>c</sup> | Quarter L (Solar) (W/Battery Vent Duct) | 18.1x25.0 |
| DQ10055 <sup>c</sup> | Quarter R (Solar)                       | 18.1x29.4 |
| DB10273              | Back Window (Heated)(8 Holes)(Solar)    | 18.6x50.3 |

<sup>a</sup> Urethane,Dam,Primer - 2 Tubes  
<sup>b</sup> Fast-Cure Urethane/Dam/Primer - Quantity 2  
<sup>c</sup> Urethane,Dam,Primer - 1 Tube

**Expedition 4 Door Utility ..... 2007-2011**

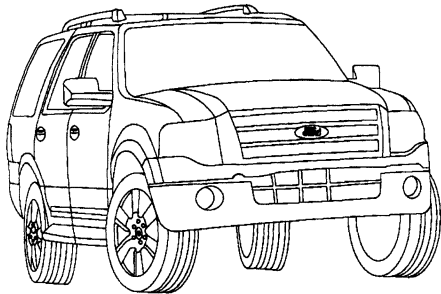

|                            |   |           |
|----------------------------|---|-----------|
| DW01863 <sup>a b d e</sup> | Windshield (Solar) (W/Third Visor Frit, Aftermarket, Rain Sensor) (10-11)         | 37.3x66.4 |
| DW01862 <sup>a b d e</sup> | Windshield (Solar) (W/Third Visor Frit, Aftermarket) (10-11)                      | 37.3x66.4 |
| DW01861 <sup>a b d e</sup> | Windshield (Solar) (W/Third Visor Frit, Aftermarket, Rain Sensor) (09)            | 37.3x66.4 |
| DW01860 <sup>a b d e</sup> | Windshield (Solar) (W/Third Visor Frit, Aftermarket) (08-09)                      | 37.3x66.4 |
| DW01798 <sup>a c d e</sup> | Windshield (Solar) (W/Third Visor Frit, Acoustic Interlayer, Rain Sensor) (10-11) | 37.3x66.4 |
| DW01796 <sup>a c d e</sup> | Windshield (Solar) (W/Third Visor Frit, Acoustic Interlayer) (10-11)              | 37.3x66.4 |
| DW01755 <sup>a c d e</sup> | Windshield (Solar) (W/Third Visor Frit, Acoustic Interlayer, Rain Sensor) (09)    | 37.3x66.4 |
| DW01742 <sup>a b d e</sup> | Windshield (Solar) (W/Third Visor Frit, Aftermarket) (07)                         | 37.3x66.4 |
| DW01706 <sup>a c d e</sup> | Windshield (Solar) (W/Third Visor Frit, Acoustic Interlayer) (08-09)              | 37.3x66.4 |
| DW01661 <sup>a c d e</sup> | Windshield (Solar) (W/Third Visor Frit, Acoustic Interlayer) (07)                 | 37.3x66.4 |
| DD11125-26                 | Door F/R-L (Solar)  | 25.2x32.1 |
| DD11127-28                 | Door R/R-L (Solar)  | 24.2x26.8 |
| DR09299                    | Roof (Solar)  | 18.0x40.0 |
| DQ11493 <sup>f</sup>       | Quarter L (Encap)(Solar) (Stationary) (08-11)                                     | 23.1x43.4 |
| DQ11098 <sup>f</sup>       | Quarter L (Encap)(Solar) (Movable)  | 23.1x43.4 |
| DQ11090 <sup>f</sup>       | Quarter L (Encap)(Solar) (Stationary) (07)  | 23.1x43.4 |
| DQ11492 <sup>f</sup>       | Quarter R (Ant)(Encap)(Solar) (Stationary) (08-11)                                | 23.1x43.4 |
| DQ11097 <sup>f</sup>       | Quarter R (Ant)(Encap)(Solar) (Movable)   | 23.1x43.4 |
| DQ11089 <sup>f</sup>       | Quarter R (Ant)(Encap)(Solar) (Stationary) (07)                                   | 23.1x43.4 |
| DV10091-92 <sup>g</sup>    | Vent R/R-L (Solar)  | 9.6x21.9  |
| DB11158 <sup>a</sup>       | Back Window (Encap)(Heated)(3 Holes)(Solar)                                       | 22.8x66.0 |

<sup>a</sup> May Require Two Person Installation  
<sup>b</sup> Not On Production Vehicles  
<sup>c</sup> On Production Vehicles  
<sup>d</sup> Urethane,Dam,Primer - 2 Tubes  
<sup>e</sup> Fast-Cure Urethane/Dam/Primer - Quantity 2  
<sup>f</sup> Foam Core Butyl Tape - Quantity 1.5  
<sup>g</sup> Urethane,Dam,Primer - 1 Tube

**Expedition EL 4 Door Utility ..... 2007-2011 (USA Only)**

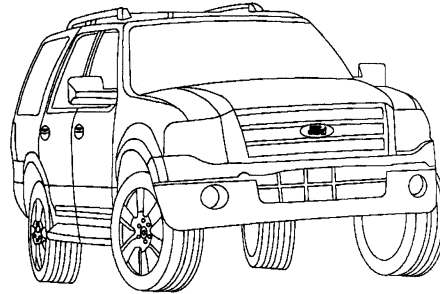

|                            |   |           |
|----------------------------|---|-----------|
| DW01863 <sup>a b d e</sup> | Windshield (Solar) (W/Third Visor Frit, Aftermarket, Rain Sensor) (10-11)         | 37.3x66.4 |
| DW01862 <sup>a b d e</sup> | Windshield (Solar) (W/Third Visor Frit, Aftermarket) (10-11)                      | 37.3x66.4 |
| DW01861 <sup>a b d e</sup> | Windshield (Solar) (W/Third Visor Frit, Aftermarket, Rain Sensor) (09)            | 37.3x66.4 |
| DW01860 <sup>a b d e</sup> | Windshield (Solar) (W/Third Visor Frit, Aftermarket) (08-09)                      | 37.3x66.4 |
| DW01798 <sup>a c d e</sup> | Windshield (Solar) (W/Third Visor Frit, Acoustic Interlayer, Rain Sensor) (10-11) | 37.3x66.4 |
| DW01796 <sup>a c d e</sup> | Windshield (Solar) (W/Third Visor Frit, Acoustic Interlayer) (10-11)              | 37.3x66.4 |
| DW01755 <sup>a c d e</sup> | Windshield (Solar) (W/Third Visor Frit, Acoustic Interlayer, Rain Sensor) (09)    | 37.3x66.4 |
| DW01742 <sup>a b d e</sup> | Windshield (Solar) (W/Third Visor Frit, Aftermarket) (07)                         | 37.3x66.4 |
| DW01706 <sup>a c d e</sup> | Windshield (Solar) (W/Third Visor Frit, Acoustic Interlayer) (08-09)              | 37.3x66.4 |
| DW01661 <sup>a c d e</sup> | Windshield (Solar) (W/Third Visor Frit, Acoustic Interlayer) (07)                 | 37.3x66.4 |
| DD11125-26                 | Door F/R-L (Solar)  | 25.2x32.1 |
| DD11127-28                 | Door R/R-L (Solar)  | 24.2x26.8 |
| DR09299                    | Roof (Solar)  | 18.0x40.0 |
| DQ11497 <sup>f</sup>       | Quarter L (Encap)(Solar) (Stationary, LWB) (08-11)                                | 22.9x58.9 |
| DQ11102 <sup>f</sup>       | Quarter L (Encap)(Solar) (Movable, LWB)   | 22.9x58.9 |
| DQ11094 <sup>f</sup>       | Quarter L (Encap)(Solar) (Stationary, LWB) (07)                                   | 22.9x58.9 |
| DQ11496 <sup>f</sup>       | Quarter R (Ant)(Encap)(Solar) (Stationary, LWB) (08-11)                           | 22.9x58.9 |
| DQ11101 <sup>f</sup>       | Quarter R (Ant)(Encap)(Solar) (Movable, LWB)                                      | 22.9x58.9 |
| DQ11093 <sup>f</sup>       | Quarter R (Ant)(Encap)(Solar) (Stationary, LWB) (07)                              | 22.9x58.9 |
| DV10091-92 <sup>g</sup>    | Vent R/R-L (Solar)  | 9.6x21.9  |
| DB11158 <sup>a</sup>       | Back Window (Encap)(Heated)(3 Holes)(Solar)                                       | 22.8x66.0 |

<sup>a</sup> May Require Two Person Installation  
<sup>b</sup> Not On Production Vehicles  
<sup>c</sup> On Production Vehicles  
<sup>d</sup> Urethane,Dam,Primer - 2 Tubes  
<sup>e</sup> Fast-Cure Urethane/Dam/Primer - Quantity 2  
<sup>f</sup> Foam Core Butyl Tape - Quantity 2  
<sup>g</sup> Urethane,Dam,Primer - 1 Tube

**Expedition MAX 4 Door Utility ..... 2007-2011  
(CANADA Only)**

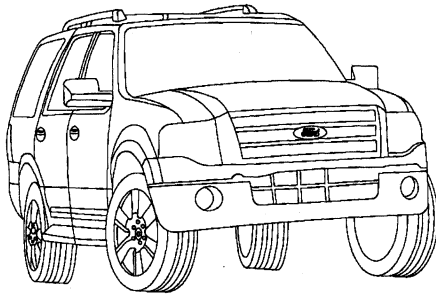

|  |           |
|--|-----------|
| DW01863 <sup>a b d e</sup> Windshield (Solar) (W/Third Visor Frit, Aftermarket, Rain Sensor) (10-11) .....         | 37.3x66.4 |
| DW01862 <sup>a b d e</sup> Windshield (Solar) (W/Third Visor Frit, Aftermarket) (10-11) .....                      | 37.3x66.4 |
| DW01861 <sup>a b d e</sup> Windshield (Solar) (W/Third Visor Frit, Aftermarket, Rain Sensor) (09) .....            | 37.3x66.4 |
| DW01860 <sup>a b d e</sup> Windshield (Solar) (W/Third Visor Frit, Aftermarket) (08-09) .....                      | 37.3x66.4 |
| DW01798 <sup>a c d e</sup> Windshield (Solar) (W/Third Visor Frit, Acoustic Interlayer, Rain Sensor) (10-11) ..... | 37.3x66.4 |
| DW01796 <sup>a c d e</sup> Windshield (Solar) (W/Third Visor Frit, Acoustic Interlayer) (10-11) .....              | 37.3x66.4 |
| DW01755 <sup>a c d e</sup> Windshield (Solar) (W/Third Visor Frit, Acoustic Interlayer, Rain Sensor) (09) .....    | 37.3x66.4 |
| DW01742 <sup>a b d e</sup> Windshield (Solar) (W/Third Visor Frit, Aftermarket) (07) .....                         | 37.3x66.4 |
| DW01706 <sup>a c d e</sup> Windshield (Solar) (W/Third Visor Frit, Acoustic Interlayer) (08-09) .....              | 37.3x66.4 |
| DW01661 <sup>a c d e</sup> Windshield (Solar) (W/Third Visor Frit, Acoustic Interlayer) (07) .....                 | 37.3x66.4 |
| DD11125-26 Door F/R-L (Solar) .....  | 25.2x32.1 |
| DD11127-28 Door R/R-L (Solar) .....  | 24.2x26.8 |
| DR09299 Roof (Solar) .....   | 18.0x40.0 |
| DQ11497 <sup>f</sup> Quarter L (Encap)(Solar) (Stationary, LWB) (08-11) ....                                       | 22.9x58.9 |
| DQ11102 <sup>f</sup> Quarter L (Encap)(Solar) (Movable, LWB) .....   | 22.9x58.9 |
| DQ11094 <sup>f</sup> Quarter L (Encap)(Solar) (Stationary, LWB) (07) .....   | 22.9x58.9 |
| DQ11496 <sup>f</sup> Quarter R (Ant)(Encap)(Solar) (Stationary, LWB) (08-11) .....                                 | 22.9x58.9 |
| DQ11101 <sup>f</sup> Quarter R (Ant)(Encap)(Solar) (Movable, LWB) .....  | 22.9x58.9 |
| DQ11093 <sup>f</sup> Quarter R (Ant)(Encap)(Solar) (Stationary, LWB) (07) .....                                    | 22.9x58.9 |
| DV10091-92 <sup>e</sup> Vent R/R-L (Solar) .....   | 9.6x21.9  |
| DB11158 <sup>a</sup> Back Window (Encap)(Heated)(3 Holes)(Solar) .....   | 22.8x66.0 |

- <sup>a</sup> May Require Two Person Installation
- <sup>b</sup> Not On Production Vehicles
- <sup>c</sup> On Production Vehicles
- <sup>d</sup> Urethane,Dam,Primer - 2 Tubes
- <sup>e</sup> Fast-Cure Urethane/Dam/Primer - Quantity 2
- <sup>f</sup> Foam Core Butyl Tape - Quantity 2
- <sup>g</sup> Urethane,Dam,Primer - 1 Tube

**Expedition 4 Door Utility ..... 2006**

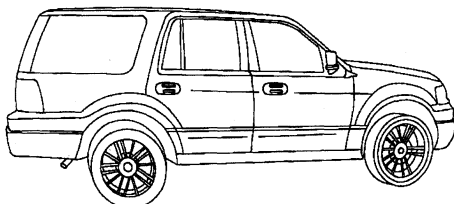

|  |           |
|--|-----------|
| DW01582 <sup>a b c</sup> Windshield (Solar) (W/Third Visor Frit) ..... | 37.3x66.4 |
| DD09927-28 Door F/R-L (Solar) .....                                    | 24.8x32.1 |

**Expedition (cont.)**

|  |           |
|--|-----------|
| DD09929-30 Door R/R-L (Solar) .....  | 24.2x26.3 |
| DR09299 Roof (Solar) .....   | 18.0x40.0 |
| DQ09934 <sup>d</sup> Quarter L (Encap)(Solar) (Movable) .....                | 23.1x43.4 |
| DQ09932 <sup>d</sup> Quarter L (Encap)(Solar) (Stationary) .....             | 23.1x43.4 |
| DQ10173-74 <sup>d</sup> Quarter R-L (Encap)(Solar) (Export Only, Movable) .. | 23.1x43.4 |
| DQ09933 <sup>d</sup> Quarter R (Ant)(Encap)(Solar) (Movable) .....           | 23.1x43.4 |
| DQ09931 <sup>d</sup> Quarter R (Ant)(Encap)(Solar) (Stationary) .....        | 23.1x43.4 |
| DV10091-92 <sup>e</sup> Vent R/R-L (Solar) .....                             | 9.6x21.9  |
| DB09935 Back Window (Encap)(Heated)(3 Holes)(Solar) .....                    | 22.8x66.0 |

<sup>a</sup> May Require Two Person Installation  
<sup>b</sup> Urethane,Dam,Primer - 2 Tubes  
<sup>c</sup> Fast-Cure Urethane/Dam/Primer - Quantity 2  
<sup>d</sup> Foam Core Butyl Tape - Quantity 1.5  
<sup>e</sup> Urethane,Dam,Primer - 1 Tube

**Explorer 4 Door Utility ..... 2011**

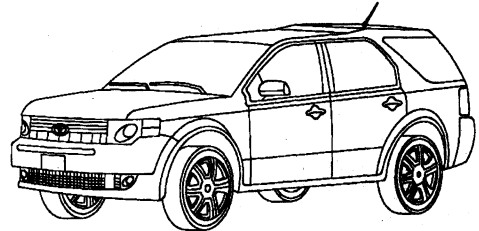

|  |           |
|--|-----------|
| DW01844 <sup>a b d</sup> Windshield (Solar) (W/Third Visor Frit, Rain Sensor) .. | 41.7x65.4 |
| DW01843 <sup>a b</sup> Windshield (Solar) (W/Third Visor Frit) .....             | 41.7x65.4 |
| DD11880-81 Door F/R-L (Solar) (Laminated) .....                                  | 22.9x36.0 |
| DD11829-30 Door F/R-L (Solar) .....  | 22.9x36.0 |
| DD11831-32 Door R/R-L (Solar) .....  | 21.4x26.6 |
| DR11845 Roof F (Solar) .....   |           |
| DR11846 <sup>c</sup> Roof R (Solar) .....  |           |
| DQ11839-40 <sup>f</sup> Quarter R-L (Solar) .....                                | 14.8x32.1 |
| DV11835-36 Vent R/R-L (Solar) .....  |           |
| DB11843 <sup>c</sup> Back Window (Heated)(Solar) .....                           | 20.8x54.9 |

<sup>a</sup> Urethane,Dam,Primer - 2 Tubes  
<sup>b</sup> Fast-Cure Urethane/Dam/Primer - Quantity 2  
<sup>c</sup> Urethane,Dam,Primer - 1.5 Tubes  
<sup>d</sup> Rain Sensor Kit  
<sup>e</sup> Urethane,Dam,Primer - 1 Tube

**Explorer 4 Door Utility ..... 2006-2010**

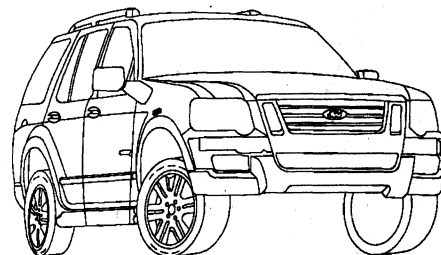

|  |           |
|--|-----------|
| DW01619 <sup>a b</sup> Windshield (Heated)(Solar) (W/Third Visor Frit) (07-08) ..... | 33.2x64.4 |
| DW01618 <sup>a b</sup> Windshield (Solar) (W/Third Visor Frit) .....                 | 33.2x64.4 |
| DD09870-71 Door F/R-L (Solar) .....  | 23.8x32.0 |
| DD10942-43 Door R/R-L (Solar) (07-10) .....  | 21.7x23.7 |
| DD09872-73 Door R/R-L (Solar) (E-Mark) (06) .....                                    | 21.7x23.7 |
| DR10982 Roof (Solar) .....   | 16.3x31.8 |
| DQ10946-47 <sup>c</sup> Quarter R-L (Encap)(Solar) (07-10) .....                     | 19.8x36.2 |
| DQ10425-26 <sup>c</sup> Quarter R-L (Encap)(Solar) (Export Only, E-Mark) ....        | 19.8x36.2 |
| DQ10424 <sup>c</sup> Quarter R (Ant)(Encap)(Solar) .....                             | 19.8x36.2 |

**Explorer (cont.)**

|   |           |
|---|-----------|
| DQ10422-23 <sup>c</sup> Quarter R-L (Encap)(Solar) .....      | 19.8x36.2 |
| DV10944-45 Vent R/R-L (Solar) (Black Moulding) (07-10) .....  | 9.7x19.6  |
| DV10093-94 Vent R/R-L (Solar) (Chrome Moulding) (08-10) ..... | 9.7x19.6  |
| DV09874-75 Vent R/R-L (Solar) (E-Mark) (06) .....             | 9.7x19.6  |
| DB10948 Back Window (Heated)(5 Holes)(Solar) .....            | 22.0x55.0 |

<sup>a</sup> Urethane,Dam,Primer - 2 Tubes  
<sup>b</sup> Fast-Cure Urethane/Dam/Primer - Quantity 2  
<sup>c</sup> Urethane,Dam,Primer - 1.5 Tubes

**Explorer SPORT TRAC 4 Door Utility ..... 2007-2010**

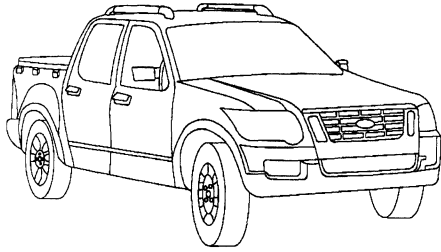

|   |           |
|---|-----------|
| DW01619 <sup>a b</sup> Windshield (Heated)(Solar) (W/Third Visor Frit) .....        | 33.2x64.4 |
| DW01618 <sup>a b</sup> Windshield (Solar) (W/Third Visor Frit) .....                | 33.2x64.4 |
| DD09870-71 Door F/R-L (Solar) .....   | 23.8x32.0 |
| DD10942-43 Door R/R-L (Solar) .....   | 21.7x23.7 |
| DR10982 Roof (Solar) .....  | 16.3x31.8 |
| DV11077-78 Vent R/R-L (Solar) .....   | 7.5x19.2  |
| DB09768 <sup>e</sup> Back Window C (Solar) (OE, Power Drop Down) .....              | 17.5x30.0 |
| DB11080 <sup>d</sup> Back Window (Encap)(Slider)(Solar) (OE, Power Drop Down) ..... | 18.8x55.2 |
| DB11079 <sup>c</sup> Back Window (Encap)(Solar) (Stationary) .....                  | 16.2x53.3 |

<sup>a</sup> Urethane,Dam,Primer - 2 Tubes  
<sup>b</sup> Fast-Cure Urethane/Dam/Primer - Quantity 2  
<sup>c</sup> Urethane,Dam,Primer - 1.5 Tubes  
<sup>d</sup> Foam Core Butyl Tape - Quantity 1.5  
<sup>e</sup> Foam Core Butyl Tape - Quantity 1

**Explorer SPORT TRAC 4 Door Utility ..... 2006**

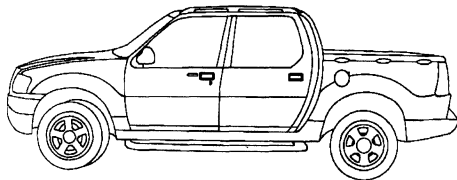

|   |           |
|---|-----------|
| DW01206 <sup>a b c</sup> Windshield (Solar) (W/V.I.N. Notch) .....                  | 30.5x63.5 |
| DD10382-83 Door F/R-L (Solar) .....   | 23.3x34.3 |
| DD09291-92 Door R/R-L (Solar) .....   | 23.3x23.3 |
| DR09298 Roof (Solar) .....  | 16.3x31.8 |
| DV09866-67 Vent R/R-L (Solar) .....   | 6.0x20.3  |
| DB09768 <sup>e</sup> Back Window C (Solar) (OE, Power Drop Down) .....              | 17.5x30.0 |
| DB10812 <sup>d</sup> Back Window (Encap)(Slider)(Solar) (OE, Power Drop Down) ..... | 18.4x53.5 |

<sup>a</sup> On Production Vehicles  
<sup>b</sup> Urethane,Dam,Primer - 2 Tubes  
<sup>c</sup> Fast-Cure Urethane/Dam/Primer - Quantity 2  
<sup>d</sup> Foam Core Butyl Tape - Quantity 1.5  
<sup>e</sup> Foam Core Butyl Tape - Quantity 1

|  |                  |
|--|------------------|
| <b>F Series F450 2 Door Standard Cab .....</b> | <b>2008-2011</b> |
| <b>F Series F650 2 Door Standard Cab .....</b> | <b>2008-2011</b> |
| <b>F Series F250 2 Door Standard Cab .....</b> | <b>2008-2011</b> |
| <b>F Series F350 2 Door Standard Cab .....</b> | <b>2008-2011</b> |
| <b>F Series F750 2 Door Standard Cab .....</b> | <b>2008-2011</b> |
| <b>F Series F550 2 Door Standard Cab .....</b> | <b>2008-2011</b> |

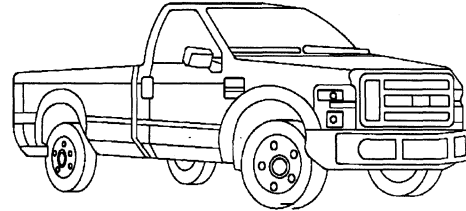

|  |           |
|--|-----------|
| DW01851 <sup>a b d e</sup> Windshield (Solar) (W/Third Visor Frit) (11) .....  | 34.9x68.9 |
| DW01833 <sup>a c d e</sup> Windshield (Solar) ("Super Duty" in 3rd Visor Frit) (11) .....                              | 34.9x68.9 |
| DW01693 <sup>a b d e</sup> Windshield (Solar) (W/Third Visor Frit) (08-10) .....                                       | 34.9x68.9 |
| DW01692 <sup>a c d e</sup> Windshield (Solar) (W/Harley Davidson Logo) (08-10) .....                                   | 34.9x68.9 |
| DW01667 <sup>a c d e</sup> Windshield (Solar) ("Super Duty" in 3rd Visor Frit) (08-10) .....                           | 34.9x68.9 |
| DD10638 Door F/L (Solar) .....   | 26.4x35.9 |
| DD11202 Door R/R (Solar) .....   | 26.4x35.9 |
| DB11792 Back Window C (Heated)(Slider)(Solar) (OE, Power) (11) .....   | 14.9x15.5 |
| DB11207 Back Window C (Solar) (OE, Power, Movable) .....   | 14.9x15.5 |
| DB11205 Back Window C (Solar) (OE, Movable, Manual) .....  | 14.9x15.5 |
| DY90117 <sup>d</sup> Back Window (Encap)(Slider)(Solar) (Black Frame, Aftermarket, Power, 3 Panel Encapsulated) .....  | 18.8x65.1 |
| DY90116 <sup>d</sup> Back Window (Encap)(Slider)(Solar) (Black Frame, Aftermarket, Manual, 3 Panel Encapsulated) ..... | 18.8x65.1 |
| DB11791 <sup>d</sup> Back Window (Encap)(Heated)(Slider)(Solar) (OE, Assembly, Power) (11) .....                       | 18.8x65.1 |
| DB11790 <sup>d</sup> Back Window (Encap)(Slider)(Solar) (OE, Assembly, Power) (11) .....                               | 18.8x65.1 |
| DB11789 <sup>d</sup> Back Window (Encap)(Slider)(Solar) (OE, Assembly, Manual) (11) .....                              | 18.8x65.1 |
| DB11683 <sup>b d</sup> Back Window (Encap)(Slider)(Solar) (Aftermarket, Power, W/O Motor, Sub-Assembly) (08-10) .....  | 18.8x65.1 |
| DB11677 <sup>c d</sup> Back Window (Encap)(Slider)(Solar) (OE, Assembly, Power) (09-10) .....                          | 18.8x65.1 |
| DB11206 <sup>d</sup> Back Window (Encap)(Slider)(Solar) (OE, Assembly, Power) (08) .....                               | 18.8x65.1 |
| DB11204 <sup>d</sup> Back Window (Encap)(Slider)(Solar) (OE, Assembly, Manual) (08-10) .....                           | 18.8x65.1 |
| DB11203 <sup>d</sup> Back Window (Solar) (Stationary) .....  | 18.8x65.1 |

<sup>a</sup> May Require Two Person Installation  
<sup>b</sup> Not On Production Vehicles  
<sup>c</sup> On Production Vehicles  
<sup>d</sup> Urethane,Dam,Primer - 2 Tubes  
<sup>e</sup> Fast-Cure Urethane/Dam/Primer - Quantity 2

**F Series F150 2 Door Standard Cab ..... 2009-2011**

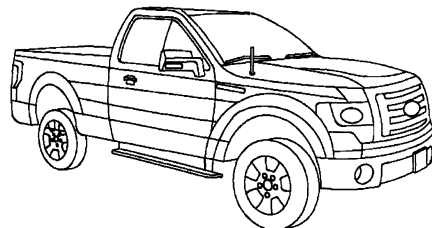



| <i>F Series</i>   | <i>(cont.)</i>   |
|---|--|
| DW01867 <sup>a b g h</sup>  | Windshield (Solar) (W/Third Visor Frit, Aftermarket, Rain Sensor) ..... 37.3x70.8                                  |
| DW01838 <sup>a c g h</sup>  | Windshield (Solar) (W/Third Visor Frit, Acoustic Interlayer, Rain Sensor) (11) ..... 37.3x70.8                     |
| DW01797 <sup>a c g h</sup>  | Windshield (Solar) (W/Third Visor Frit, W/Harley Davidson Logo) (10) ..... 37.3x70.8                               |
| DW01749 <sup>a c g h</sup>  | Windshield (Solar) (W/Third Visor Frit, 'F150' in 3rd Visor Frit) ..... 37.3x70.8                                  |
| DW01748 <sup>a c g h</sup>  | Windshield (Solar) (W/Third Visor Frit, Acoustic Interlayer, Rain Sensor) (09-10) ..... 37.3x70.8                  |
| DW01747 <sup>a b g h</sup>  | Windshield (Solar) (W/Third Visor Frit) ..... 37.3x70.8  |
| DD10464-65  | Door F/R-L (Solar) ..... 26.8x33.4   |
| DR09299   | Roof (Solar) (09) ..... 18.0x40.0  |
| DB11709   | Back Window C (Heated)(Solar) (OE, Power) (10-11) . 14.9x15.2  |
| DB10767   | Back Window C (Solar) (OE, Movable, Manual) ..... 15.0x15.2  |
| DB10672   | Back Window C (Solar) (OE, Power, Movable) (09) .... 14.9x15.2   |
| DY90114 <sup>f</sup>  | Back Window (Slider)(Solar) (Aftermarket, 1 Panel Flush Fit, Manual) ..... 18.5x65.5                               |
| DY90110 <sup>f</sup>  | Back Window (Encap)(Slider)(Solar) (Black Frame, Aftermarket, Power, Bolt-In, 3 Panel Encapsulated) .... 18.5x65.5 |
| DY90109 <sup>f</sup>  | Back Window (Encap)(Slider)(Solar) (Black Frame, Aftermarket, Manual, Bolt-In, 3 Panel Encapsulated) .. 18.5x65.5  |
| DB11827 <sup>b f</sup>  | Back Window (Encap)(Slider)(Solar) (Assembly, Aftermarket, Power, 3 Piece, W/O Motor) (09) ..... 18.5x65.5         |
| DB11710 <sup>d</sup>  | Back Window (Encap)(Heated)(Solar) (Stationary, 4-Pin Connector) (10) ..... 17.0x64.0                              |
| DB11708 <sup>f</sup>  | Back Window (Encap)(Heated)(Slider)(Solar) (OE, 3 Piece Assembly, Power) (10-11) ..... 18.5x65.5                   |
| DB11577 <sup>c f</sup>  | Back Window (Encap)(Slider)(Solar) (OE, Assembly, Power, 3 Piece) (09) ..... 18.5x65.5                             |
| DB11576 <sup>f</sup>  | Back Window (Encap)(Slider)(Solar) (OE, Assembly, 3 Piece, Manual) ..... 18.5x65.5                                 |
| DB11523 <sup>i</sup>  | Back Window (Encap)(Heated)(Solar) (Stationary, 2-Pin Connector) (09)(11) ..... 17.0x64.0                          |
| DB11522 <sup>e</sup>  | Back Window (Encap)(Solar) (Stationary) ..... 17.0x64.0  |
| <sup>a</sup> May Require Two Person Installation<br><sup>b</sup> Not On Production Vehicles<br><sup>c</sup> On Production Vehicles<br><sup>d</sup> Urethane,Dam,Primer - 1.5 Tubes<br><sup>e</sup> Foam Core Butyl Tape - Quantity 1.5<br><sup>f</sup> Foam Core Butyl Tape - Quantity 2<br><sup>g</sup> Urethane,Dam,Primer - 2.5 Tubes<br><sup>h</sup> Fast-Cure Urethane/Dam/Primer - Quantity 2.5<br><sup>i</sup> Foam Core Butyl Tape (09-11) - Quantity 1.5 |  |

**F Series F150 2 Door Standard Cab ..... 2006-2008**

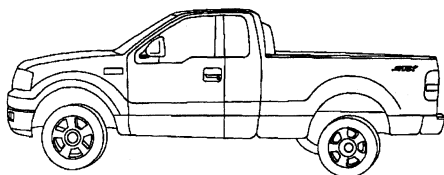

|                            |  |
|----------------------------|--|
| DW01621 <sup>a c f g</sup> | Windshield (Solar) (W/Third Visor Frit, W/Harley Davidson Logo) ..... 37.2x70.7                                    |
| DW01551 <sup>a d f g</sup> | Windshield (Solar) (W/Third Visor Frit, Aftermarket) ..... 37.2x70.7   |
| DW01548 <sup>a d f g</sup> | Windshield (Solar) (W/Third Visor Frit) ..... 37.2x70.7  |
| DW01529 <sup>a e f g</sup> | Windshield (Solar) (W/Third Visor Frit, 'F150' in 3rd Visor Frit) ..... 37.2x70.7                                  |
| DD10462-63                 | Door F/R-L (Solar) ..... 26.4x27.1   |
| DQ10468-69 <sup>j</sup>    | Quarter R-L (Encap)(Solar) (Stationary, Rear Access Door) ..... 11.3x21.0  |
| DB10767                    | Back Window C (Solar) (OE, Movable, Manual) ..... 15.0x15.2  |
| DB10672                    | Back Window C (Solar) (OE, Power, Movable) ..... 14.9x15.2   |
| DY90114 <sup>f</sup>       | Back Window (Slider)(Solar) (Aftermarket, 1 Panel Flush Fit, Manual) ..... 18.5x65.5                               |
| DY90110 <sup>f</sup>       | Back Window (Encap)(Slider)(Solar) (Black Frame, Aftermarket, Power, Bolt-In, 3 Panel Encapsulated) .... 18.5x65.5 |

| <i>F Series</i>  | <i>(cont.)</i>   |
|--|--|
| DY90109 <sup>f</sup>   | Back Window (Encap)(Slider)(Solar) (Black Frame, Aftermarket, Manual, Bolt-In, 3 Panel Encapsulated) . 18.5x65.5           |
| DB11133 <sup>b c i</sup>   | Back Window (Encap)(Slider)(Solar) (OE, Manual & Power, W/O Center Sliding Glass, W/O Motor, Sub-Assembly) ..... 18.5x65.5 |
| DB10951 <sup>f</sup>   | Back Window (Encap)(Slider)(Solar) (OE, Assembly, Power, 3 Piece) ..... 18.5x65.5  |
| DB10474 <sup>f</sup>   | Back Window (Encap)(Slider)(Solar) (OE, Assembly, 3 Piece, Manual) ..... 18.5x65.5   |
| DB10473 <sup>h</sup>   | Back Window (Encap)(Heated)(Solar) (Stationary) ... 17.0x64.0  |
| DB10472 <sup>h</sup>   | Back Window (Encap)(Solar) (Stationary) ..... 17.0x64.0  |
| <sup>a</sup> May Require Two Person Installation<br><sup>b</sup> When Replacing a Power Slider, Plastic Insert # 4L3Z 15422B68 AA in the Lower Glass Run Channel Must Be Removed<br><sup>c</sup> Does Not Come With Center Slider<br><sup>d</sup> Not On Production Vehicles<br><sup>e</sup> On Production Vehicles<br><sup>f</sup> Urethane,Dam,Primer - 2 Tubes<br><sup>g</sup> Fast-Cure Urethane/Dam/Primer - Quantity 2<br><sup>h</sup> Foam Core Butyl Tape - Quantity 1.5<br><sup>i</sup> Foam Core Butyl Tape - Quantity 2<br><sup>j</sup> Foam Core Butyl Tape - Quantity 1 |  |

|   |                  |
|---|------------------|
| <b>F Series F650 2 Door Standard Cab.....</b> | <b>2006-2007</b> |
| <b>F Series F350 2 Door Standard Cab.....</b> | <b>2006-2007</b> |
| <b>F Series F250 2 Door Standard Cab.....</b> | <b>2006-2007</b> |
| <b>F Series F550 2 Door Standard Cab.....</b> | <b>2006-2007</b> |
| <b>F Series F750 2 Door Standard Cab.....</b> | <b>2006-2007</b> |
| <b>F Series F450 2 Door Standard Cab.....</b> | <b>2006-2007</b> |

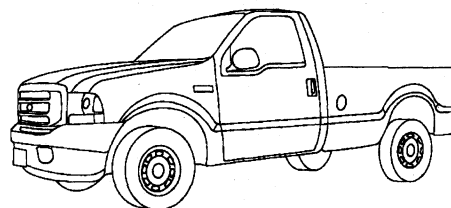

|   |   |
|---|---|
| DW01537 <sup>a b d e</sup>  | Windshield (Solar) (W/Third Visor Frit, Aftermarket) ..... 34.9x68.9  |
| DW01522 <sup>a c d e</sup>  | Windshield (Solar) ("Super Duty" in 3rd Visor Frit) . 34.9x68.9   |
| DD10638   | Door F/L (Solar) ..... 26.4x35.9  |
| DD09327   | Door F/R (Solar) ..... 26.4x35.9  |
| DB11201   | Back Window C (Slider)(Solar) (OE, Power, Movable) ..... 15.4x18.1  |
| DB10803   | Back Window C (Solar) (OE, Power, Movable, W/Motor & Cable) ..... 15.4x18.1                                     |
| DB09410   | Back Window C (Slider)(Solar) (OE, Movable, Manual) ..... 15.4x18.1   |
| DY90101   | Back Window (Encap)(Slider) (Black Frame, Aftermarket, Gasket Set, Manual, 3 Panel Encapsulated) .... 18.5x64.6 |
| DY90094   | Back Window (Encap)(Slider) (Black Frame, Aftermarket, 4 Panel Encapsulated, Gasket Set, Manual) .... 18.5x64.6 |
| DY90085   | Back Window (Encap)(Slider)(Solar) (3 Piece Assembly, Aftermarket, Power, Gasket Set) ..... 18.5x64.6           |
| DY90084   | Back Window (Encap)(Slider)(Solar) (3 Piece Assembly, Aftermarket, Gasket Set) ..... 18.5x64.6                  |
| DB10840   | Back Window (Slider)(Solar) (OE, Assembly, 3 Piece) ..... 18.5x64.6   |
| DB10802   | Back Window (Slider)(Solar) (OE, Assembly, Power, 3 Piece) ..... 18.5x64.6                                      |
| DB09333   | Back Window (Solar) (Stationary) ..... 18.5x64.6  |
| <sup>a</sup> May Require Two Person Installation<br><sup>b</sup> Not On Production Vehicles<br><sup>c</sup> On Production Vehicles<br><sup>d</sup> Urethane,Dam,Primer - 2 Tubes<br><sup>e</sup> Fast-Cure Urethane/Dam/Primer - Quantity 2 |   |

|   |                  |
|---|------------------|
| <b>F Series F650 2 Door Super Cab</b> ..... | <b>2008-2011</b> |
| <b>F Series F250 2 Door Super Cab</b> ..... | <b>2008-2011</b> |
| <b>F Series F550 2 Door Super Cab</b> ..... | <b>2008-2011</b> |
| <b>F Series F450 2 Door Super Cab</b> ..... | <b>2008-2011</b> |
| <b>F Series F350 2 Door Super Cab</b> ..... | <b>2008-2011</b> |
| <b>F Series F750 2 Door Super Cab</b> ..... | <b>2008-2011</b> |

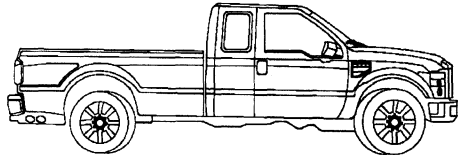

|  |                  |
|--|------------------|
| <b>DW01851<sup>a b d e</sup></b> Windshield (Solar) (W/Third Visor Frit) (11) .....  | <b>34.9x68.9</b> |
| <b>DW01833<sup>a c d e</sup></b> Windshield (Solar) ("Super Duty" in 3rd Visor Frit) (11) .....                              | <b>34.9x68.9</b> |
| <b>DW01693<sup>a b d e</sup></b> Windshield (Solar) (W/Third Visor Frit) (08-10) .....                                       | <b>34.9x68.9</b> |
| <b>DW01692<sup>a c d e</sup></b> Windshield (Solar) (W/Harley Davidson Logo) (08-10) .....                                   | <b>34.9x68.9</b> |
| <b>DW01667<sup>a c d e</sup></b> Windshield (Solar) ("Super Duty" in 3rd Visor Frit) (08-10) .....                           | <b>34.9x68.9</b> |
| <b>DD10638</b> Door F/L (Solar) .....  | <b>26.4x35.9</b> |
| <b>DD11202</b> Door F/R (Solar) .....  | <b>26.4x35.9</b> |
| <b>DQ09331-32<sup>f</sup></b> Quarter R-L (3 Holes)(Solar) (Movable, Rear Access Door) .....                                 | <b>16.1x21.9</b> |
| <b>DB11792</b> Back Window C (Heated)(Slider)(Solar) (OE, Power) (11) .....  | <b>14.9x15.5</b> |
| <b>DB11207</b> Back Window C (Solar) (OE, Power, Movable) .....  | <b>14.9x15.5</b> |
| <b>DB11205</b> Back Window C (Solar) (OE, Movable, Manual) .....   | <b>14.9x15.5</b> |
| <b>DY90117<sup>d</sup></b> Back Window (Encap)(Slider)(Solar) (Black Frame, Aftermarket, Power, 3 Panel Encapsulated) .....  | <b>18.8x65.1</b> |
| <b>DY90116<sup>d</sup></b> Back Window (Encap)(Slider)(Solar) (Black Frame, Aftermarket, Manual, 3 Panel Encapsulated) ..... | <b>18.8x65.1</b> |
| <b>DB11791<sup>d</sup></b> Back Window (Encap)(Heated)(Slider)(Solar) (OE, Assembly, Power) (11) .....                       | <b>18.8x65.1</b> |
| <b>DB11790<sup>d</sup></b> Back Window (Encap)(Slider)(Solar) (OE, Assembly, Power) (11) .....                               | <b>18.8x65.1</b> |
| <b>DB11789<sup>d</sup></b> Back Window (Encap)(Slider)(Solar) (OE, Assembly, Manual) (11) .....                              | <b>18.8x65.1</b> |
| <b>DB11683<sup>b d</sup></b> Back Window (Encap)(Slider)(Solar) (Aftermarket, Power, W/O Motor, Sub-Assembly) (08-10) .....  | <b>18.8x65.1</b> |
| <b>DB11677<sup>c d</sup></b> Back Window (Encap)(Slider)(Solar) (OE, Assembly, Power) (09-10) .....                          | <b>18.8x65.1</b> |
| <b>DB11206<sup>d</sup></b> Back Window (Encap)(Slider)(Solar) (OE, Assembly, Power) (08) .....                               | <b>18.8x65.1</b> |
| <b>DB11204<sup>d</sup></b> Back Window (Encap)(Slider)(Solar) (OE, Assembly, Manual) (08-10) .....                           | <b>18.8x65.1</b> |
| <b>DB11203<sup>d</sup></b> Back Window (Solar) (Stationary) .....  | <b>18.8x65.1</b> |

<sup>a</sup> May Require Two Person Installation  
<sup>b</sup> Not On Production Vehicles  
<sup>c</sup> On Production Vehicles  
<sup>d</sup> Urethane,Dam,Primer - 2 Tubes  
<sup>e</sup> Fast-Cure Urethane/Dam/Primer - Quantity 2  
<sup>f</sup> Foam Core Butyl Tape - Quantity 1

|   |                  |
|---|------------------|
| <b>F Series F150 2 Door Super Cab</b> ..... | <b>2009-2011</b> |
|---|------------------|

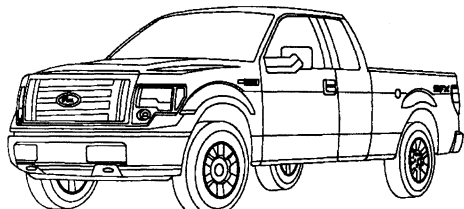

|  |                  |
|--|------------------|
| <b>DW01867<sup>a b g h</sup></b> Windshield (Solar) (W/Third Visor Frit, Aftermarket, Rain Sensor) ..... | <b>37.3x70.8</b> |
|--|------------------|

**F Series (cont.)**

|   |                  |
|---|------------------|
| <b>DW01838<sup>a c g h</sup></b> Windshield (Solar) (W/Third Visor Frit, Acoustic Interlayer, Rain Sensor) (11) .....                 | <b>37.3x70.8</b> |
| <b>DW01797<sup>a c g h</sup></b> Windshield (Solar) (W/Third Visor Frit, W/Harley Davidson Logo) (10) .....                           | <b>37.3x70.8</b> |
| <b>DW01749<sup>a c g h</sup></b> Windshield (Solar) (W/Third Visor Frit, 'F150' in 3rd Visor Frit) .....                              | <b>37.3x70.8</b> |
| <b>DW01748<sup>a c g h</sup></b> Windshield (Solar) (W/Third Visor Frit, Acoustic Interlayer, Rain Sensor) (09-10) .....              | <b>37.3x70.8</b> |
| <b>DW01747<sup>a b g h</sup></b> Windshield (Solar) (W/Third Visor Frit) .....  | <b>37.3x70.8</b> |
| <b>DD10464-65</b> Door F/R-L (Solar) .....  | <b>26.8x33.4</b> |
| <b>DR09299</b> Roof (Solar) (09) .....  | <b>18.0x40.0</b> |
| <b>DQ10470-71</b> Quarter R-L (Solar) (Rear Access Door) .....  | <b>16.6x24.9</b> |
| <b>DB11709</b> Back Window C (Heated)(Solar) (OE, Power) (10-11) .....  | <b>14.9x15.2</b> |
| <b>DB10767</b> Back Window C (Solar) (OE, Movable, Manual) .....  | <b>15.0x15.2</b> |
| <b>DB10672</b> Back Window C (Solar) (OE, Power, Movable) (09) .....  | <b>14.9x15.2</b> |
| <b>DY90114<sup>f</sup></b> Back Window (Slider)(Solar) (Aftermarket, 1 Panel Flush Fit, Manual) .....                                 | <b>18.5x65.5</b> |
| <b>DY90110<sup>f</sup></b> Back Window (Encap)(Slider)(Solar) (Black Frame, Aftermarket, Power, Bolt-In, 3 Panel Encapsulated) .....  | <b>18.5x65.5</b> |
| <b>DY90109<sup>f</sup></b> Back Window (Encap)(Slider)(Solar) (Black Frame, Aftermarket, Manual, Bolt-In, 3 Panel Encapsulated) ..... | <b>18.5x65.5</b> |
| <b>DB11827<sup>b f</sup></b> Back Window (Encap)(Slider)(Solar) (Assembly, Aftermarket, Power, 3 Piece, W/O Motor) (09) .....         | <b>18.5x65.5</b> |
| <b>DB11710<sup>d</sup></b> Back Window (Encap)(Heated)(Solar) (Stationary, 4-Pin Connector) (10) .....                                | <b>17.0x64.0</b> |
| <b>DB11708<sup>f</sup></b> Back Window (Encap)(Heated)(Slider)(Solar) (OE, 3 Piece Assembly, Power) (10-11) .....                     | <b>18.5x65.5</b> |
| <b>DB11577<sup>c f</sup></b> Back Window (Encap)(Slider)(Solar) (OE, Assembly, Power, 3 Piece) (09) .....                             | <b>18.5x65.5</b> |
| <b>DB11576<sup>f</sup></b> Back Window (Encap)(Slider)(Solar) (OE, Assembly, 3 Piece, Manual) .....                                   | <b>18.5x65.5</b> |
| <b>DB11523<sup>i</sup></b> Back Window (Encap)(Heated)(Solar) (Stationary, 2-Pin Connector) (09)(11) .....                            | <b>17.0x64.0</b> |
| <b>DB11522<sup>e</sup></b> Back Window (Encap)(Solar) (Stationary) .....  | <b>17.0x64.0</b> |

<sup>a</sup> May Require Two Person Installation  
<sup>b</sup> Not On Production Vehicles  
<sup>c</sup> On Production Vehicles  
<sup>d</sup> Urethane,Dam,Primer - 1.5 Tubes  
<sup>e</sup> Foam Core Butyl Tape - Quantity 1.5  
<sup>f</sup> Foam Core Butyl Tape - Quantity 2  
<sup>g</sup> Urethane,Dam,Primer - 2.5 Tubes  
<sup>h</sup> Fast-Cure Urethane/Dam/Primer - Quantity 2.5  
<sup>i</sup> Foam Core Butyl Tape (09-11) - Quantity 1.5

|   |                  |
|---|------------------|
| <b>F Series F150 2 Door Super Cab</b> ..... | <b>2006-2008</b> |
|---|------------------|

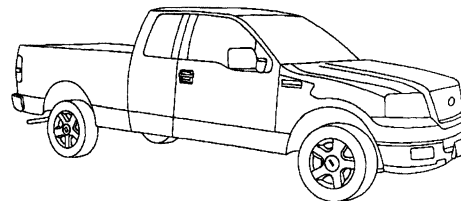

|  |                  |
|--|------------------|
| <b>DW01621<sup>a e f g</sup></b> Windshield (Solar) (W/Third Visor Frit, W/Harley Davidson Logo) .....                               | <b>37.2x70.7</b> |
| <b>DW01551<sup>a d f g</sup></b> Windshield (Solar) (W/Third Visor Frit, Aftermarket) .....  | <b>37.2x70.7</b> |
| <b>DW01548<sup>a d f g</sup></b> Windshield (Solar) (W/Third Visor Frit) .....   | <b>37.2x70.7</b> |
| <b>DW01529<sup>a e f g</sup></b> Windshield (Solar) (W/Third Visor Frit, 'F150' in 3rd Visor Frit) .....                             | <b>37.2x70.7</b> |
| <b>DD10464-65</b> Door F/R-L (Solar) .....   | <b>26.8x33.4</b> |
| <b>DR09299</b> Roof (Solar) .....  | <b>18.0x40.0</b> |
| <b>DQ10470-71</b> Quarter R-L (Solar) (Rear Access Door) .....   | <b>16.6x24.9</b> |
| <b>DB10767</b> Back Window C (Solar) (OE, Movable, Manual) .....   | <b>15.0x15.2</b> |
| <b>DB10672</b> Back Window C (Solar) (OE, Power, Movable) .....  | <b>14.9x15.2</b> |
| <b>DY90114<sup>i</sup></b> Back Window (Slider)(Solar) (Aftermarket, 1 Panel Flush Fit, Manual) .....                                | <b>18.5x65.5</b> |
| <b>DY90110<sup>i</sup></b> Back Window (Encap)(Slider)(Solar) (Black Frame, Aftermarket, Power, Bolt-In, 3 Panel Encapsulated) ..... | <b>18.5x65.5</b> |

| <b>F Series</b>                |   | <i>(cont.)</i>   |
|--------------------------------|---|------------------|
| <b>DY90109<sup>d</sup></b>     | Back Window (Encap)(Slider)(Solar) (Black Frame, Aftermarket, Manual, Bolt-In, 3 Panel Encapsulated) ..       | <b>18.5x65.5</b> |
| <b>DB11133<sup>b c i</sup></b> | Back Window (Encap)(Slider)(Solar) (OE, Manual & Power, W/O Center Sliding Glass, W/O Motor, Sub-Assembly) .. | <b>18.5x65.5</b> |
| <b>DB10951<sup>d</sup></b>     | Back Window (Encap)(Slider)(Solar) (OE, Assembly, Power, 3 Piece) ..  | <b>18.5x65.5</b> |
| <b>DB10474<sup>d</sup></b>     | Back Window (Encap)(Slider)(Solar) (OE, Assembly, 3 Piece, Manual) ..   | <b>18.5x65.5</b> |
| <b>DB10473<sup>h</sup></b>     | Back Window (Encap)(Heated)(Solar) (Stationary) ....  | <b>17.0x64.0</b> |
| <b>DB10472<sup>h</sup></b>     | Back Window (Encap)(Solar) (Stationary) ..  | <b>17.0x64.0</b> |

<sup>a</sup> May Require Two Person Installation  
<sup>b</sup> When Replacing a Power Slider, Plastic Insert # 4L3Z 15422B68 AA in the Lower Glass Run Channel Must Be Removed  
<sup>c</sup> Does Not Come With Center Slider  
<sup>d</sup> Not On Production Vehicles  
<sup>e</sup> On Production Vehicles  
<sup>f</sup> Urethane, Dam, Primer - 2 Tubes  
<sup>g</sup> Fast-Cure Urethane/Dam/Primer - Quantity 2  
<sup>h</sup> Foam Core Butyl Tape - Quantity 1.5  
<sup>i</sup> Foam Core Butyl Tape - Quantity 2

|   |                  |
|---|------------------|
| <b>F Series F250 2 Door Super Cab</b> ..... | <b>2006-2007</b> |
| <b>F Series F650 2 Door Super Cab</b> ..... | <b>2006-2007</b> |
| <b>F Series F550 2 Door Super Cab</b> ..... | <b>2006-2007</b> |
| <b>F Series F450 2 Door Super Cab</b> ..... | <b>2006-2007</b> |
| <b>F Series F750 2 Door Super Cab</b> ..... | <b>2006-2007</b> |
| <b>F Series F350 2 Door Super Cab</b> ..... | <b>2006-2007</b> |

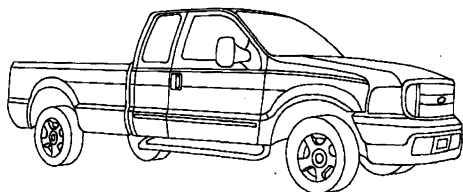

|                                  |  |                  |
|----------------------------------|--|------------------|
| <b>DW01538<sup>a c d e</sup></b> | Windshield (Solar) (W/Harley Davidson Logo) .....  | <b>34.9x68.9</b> |
| <b>DW01537<sup>a b d e</sup></b> | Windshield (Solar) (W/Third Visor Frit, Aftermarket) ..  | <b>34.9x68.9</b> |
| <b>DW01522<sup>a c d e</sup></b> | Windshield (Solar) ("Super Duty" in 3rd Visor Frit) ..   | <b>34.9x68.9</b> |
| <b>DD10638</b>                   | Door F/L (Solar) .....   | <b>26.4x35.9</b> |
| <b>DD09327</b>                   | Door F/R (Solar) .....   | <b>26.4x35.9</b> |
| <b>DQ09331-32<sup>f</sup></b>    | Quarter R-L (3 Holes)(Solar) (Movable, Rear Access Door) .....   | <b>16.1x21.9</b> |
| <b>DB11201</b>                   | Back Window C (Slider)(Solar) (OE, Power, Movable) .....   | <b>15.4x18.1</b> |
| <b>DB10803</b>                   | Back Window C (Solar) (OE, Power, Movable, W/ Motor & Cable) .....                                     | <b>15.4x18.1</b> |
| <b>DB09410</b>                   | Back Window C (Slider)(Solar) (OE, Movable, Manual) .....  | <b>15.4x18.1</b> |
| <b>DY90101</b>                   | Back Window (Encap)(Slider) (Black Frame, Aftermarket, Gasket Set, Manual, 3 Panel Encapsulated) ..... | <b>18.5x64.6</b> |
| <b>DY90094</b>                   | Back Window (Encap)(Slider) (Black Frame, Aftermarket, 4 Panel Encapsulated, Gasket Set, Manual) ..... | <b>18.5x64.6</b> |
| <b>DY90085</b>                   | Back Window (Encap)(Slider)(Solar) (3 Piece Assembly, Aftermarket, Power, Gasket Set) .....            | <b>18.5x64.6</b> |
| <b>DY90084</b>                   | Back Window (Encap)(Slider)(Solar) (3 Piece Assembly, Aftermarket, Gasket Set) .....                   | <b>18.5x64.6</b> |
| <b>DB10840</b>                   | Back Window (Slider)(Solar) (OE, Assembly, 3 Piece) .....  | <b>18.5x64.6</b> |
| <b>DB10802</b>                   | Back Window (Slider)(Solar) (OE, Assembly, Power, 3 Piece) .....                                       | <b>18.5x64.6</b> |
| <b>DB09333</b>                   | Back Window (Solar) (Stationary) .....   | <b>18.5x64.6</b> |

<sup>a</sup> May Require Two Person Installation  
<sup>b</sup> Not On Production Vehicles  
<sup>c</sup> On Production Vehicles  
<sup>d</sup> Urethane, Dam, Primer - 2 Tubes  
<sup>e</sup> Fast-Cure Urethane/Dam/Primer - Quantity 2  
<sup>f</sup> Foam Core Butyl Tape - Quantity 1

|  |                  |
|--|------------------|
| <b>F Series F750 4 Door Crew Cab</b> ..... | <b>2008-2011</b> |
| <b>F Series F650 4 Door Crew Cab</b> ..... | <b>2008-2011</b> |
| <b>F Series F350 4 Door Crew Cab</b> ..... | <b>2008-2011</b> |
| <b>F Series F250 4 Door Crew Cab</b> ..... | <b>2008-2011</b> |
| <b>F Series F450 4 Door Crew Cab</b> ..... | <b>2008-2011</b> |
| <b>F Series F550 4 Door Crew Cab</b> ..... | <b>2008-2011</b> |

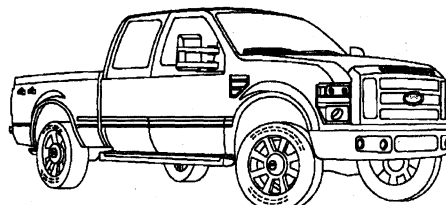

|                                  |   |                  |
|----------------------------------|---|------------------|
| <b>DW01851<sup>a b d e</sup></b> | Windshield (Solar) (W/Third Visor Frit) (11) .....  | <b>34.9x68.9</b> |
| <b>DW01833<sup>a c d e</sup></b> | Windshield (Solar) ("Super Duty" in 3rd Visor Frit) (11) .....                                    | <b>34.9x68.9</b> |
| <b>DW01693<sup>a b d e</sup></b> | Windshield (Solar) (W/Third Visor Frit) (08-10) .....   | <b>34.9x68.9</b> |
| <b>DW01692<sup>a c d e</sup></b> | Windshield (Solar) (W/Harley Davidson Logo) (08-10) .....   | <b>34.9x68.9</b> |
| <b>DW01667<sup>a c d e</sup></b> | Windshield (Solar) ("Super Duty" in 3rd Visor Frit) (08-10) .....                                 | <b>34.9x68.9</b> |
| <b>DD10638</b>                   | Door F/L (Solar) .....  | <b>26.4x35.9</b> |
| <b>DD11202</b>                   | Door F/R (Solar) .....  | <b>26.4x35.9</b> |
| <b>DD09329-30</b>                | Door R/R-L (Solar) .....  | <b>24.0x26.5</b> |
| <b>DR09299</b>                   | Roof (Solar) .....  | <b>18.0x40.0</b> |
| <b>DB11792</b>                   | Back Window C (Heated)(Slider)(Solar) (OE, Power) (11) .....                                      | <b>14.9x15.5</b> |
| <b>DB11207</b>                   | Back Window C (Solar) (OE, Power, Movable) .....  | <b>14.9x15.5</b> |
| <b>DB11205</b>                   | Back Window C (Solar) (OE, Movable, Manual) .....   | <b>14.9x15.5</b> |
| <b>DY90117<sup>d</sup></b>       | Back Window (Encap)(Slider)(Solar) (Black Frame, Aftermarket, Power, 3 Panel Encapsulated) .....  | <b>18.8x65.1</b> |
| <b>DY90116<sup>d</sup></b>       | Back Window (Encap)(Slider)(Solar) (Black Frame, Aftermarket, Manual, 3 Panel Encapsulated) ..... | <b>18.8x65.1</b> |
| <b>DB11791<sup>d</sup></b>       | Back Window (Encap)(Heated)(Slider)(Solar) (OE, Assembly, Power) (11) .....                       | <b>18.8x65.1</b> |
| <b>DB11790<sup>d</sup></b>       | Back Window (Encap)(Slider)(Solar) (OE, Assembly, Power) (11) .....                               | <b>18.8x65.1</b> |
| <b>DB11789<sup>d</sup></b>       | Back Window (Encap)(Slider)(Solar) (OE, Assembly, Manual) (11) .....                              | <b>18.8x65.1</b> |
| <b>DB11683<sup>b d</sup></b>     | Back Window (Encap)(Slider)(Solar) (Aftermarket, Power, W/O Motor, Sub-Assembly) (08-10) .....    | <b>18.8x65.1</b> |
| <b>DB11677<sup>c d</sup></b>     | Back Window (Encap)(Slider)(Solar) (OE, Assembly, Power) (09-10) .....                            | <b>18.8x65.1</b> |
| <b>DB11206<sup>d</sup></b>       | Back Window (Encap)(Slider)(Solar) (OE, Assembly, Power) (08) .....                               | <b>18.8x65.1</b> |
| <b>DB11204<sup>d</sup></b>       | Back Window (Encap)(Slider)(Solar) (OE, Assembly, Manual) (08-10) .....                           | <b>18.8x65.1</b> |
| <b>DB11203<sup>d</sup></b>       | Back Window (Solar) (Stationary) .....  | <b>18.8x65.1</b> |

<sup>a</sup> May Require Two Person Installation  
<sup>b</sup> Not On Production Vehicles  
<sup>c</sup> On Production Vehicles  
<sup>d</sup> Urethane, Dam, Primer - 2 Tubes  
<sup>e</sup> Fast-Cure Urethane/Dam/Primer - Quantity 2

**F Series F150 4 Door Crew Cab ..... 2009-2011**

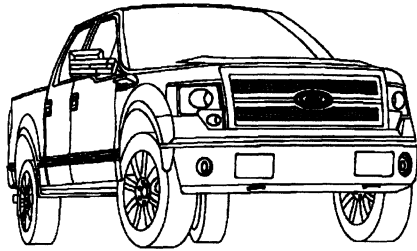

|                            |  |           |
|----------------------------|--|-----------|
| DW01867 <sup>a b g h</sup> | Windshield (Solar) (W/Third Visor Frit, Aftermarket, Rain Sensor) .....                                  | 37.3x70.8 |
| DW01838 <sup>a c g h</sup> | Windshield (Solar) (W/Third Visor Frit, Acoustic Interlayer, Rain Sensor) (11) .....                     | 37.3x70.8 |
| DW01797 <sup>a c g h</sup> | Windshield (Solar) (W/Third Visor Frit, W/Harley Davidson Logo) (10) .....                               | 37.3x70.8 |
| DW01749 <sup>a c g h</sup> | Windshield (Solar) (W/Third Visor Frit, 'F150' in 3rd Visor Frit) .....                                  | 37.3x70.8 |
| DW01748 <sup>a c g h</sup> | Windshield (Solar) (W/Third Visor Frit, Acoustic Interlayer, Rain Sensor) (09-10) .....                  | 37.3x70.8 |
| DW01747 <sup>a b g h</sup> | Windshield (Solar) (W/Third Visor Frit) .....  | 37.3x70.8 |
| DD10464-65                 | Door F/R-L (Solar) .....   | 26.8x33.4 |
| DD11520-21                 | Door R/R-L (Solar) (Platinum Edition) .....  | 26.3x27.8 |
| DD11518-19                 | Door R/R-L (Solar) .....   | 26.3x27.8 |
| DR09299                    | Roof (Solar) (09) .....  | 18.0x40.0 |
| DB11709                    | Back Window C (Heated)(Solar) (OE, Power) (10-11) .....  | 14.9x15.2 |
| DB10767                    | Back Window C (Solar) (OE, Movable, Manual) .....  | 15.0x15.2 |
| DB10672                    | Back Window C (Solar) (OE, Power, Movable) (09) .....  | 14.9x15.2 |
| DY90114 <sup>f</sup>       | Back Window (Slider)(Solar) (Aftermarket, 1 Panel Flush Fit, Manual) .....                               | 18.5x65.5 |
| DY90110 <sup>f</sup>       | Back Window (Encap)(Slider)(Solar) (Black Frame, Aftermarket, Power, Bolt-In, 3 Panel Encapsulated) .... | 18.5x65.5 |
| DY90109 <sup>f</sup>       | Back Window (Encap)(Slider)(Solar) (Black Frame, Aftermarket, Manual, Bolt-In, 3 Panel Encapsulated) ..  | 18.5x65.5 |
| DB11827 <sup>b f</sup>     | Back Window (Encap)(Slider)(Solar) (Assembly, Aftermarket, Power, 3 Piece, W/O Motor) (09) .....         | 18.5x65.5 |
| DB11710 <sup>d</sup>       | Back Window (Encap)(Heated)(Solar) (Stationary, 4-Pin Connector) (10) .....                              | 17.0x64.0 |
| DB11708 <sup>f</sup>       | Back Window (Encap)(Heated)(Slider)(Solar) (OE, 3 Piece Assembly, Power) (10-11) .....                   | 18.5x65.5 |
| DB11577 <sup>c f</sup>     | Back Window (Encap)(Slider)(Solar) (OE, Assembly, Power, 3 Piece) (09) .....                             | 18.5x65.5 |
| DB11576 <sup>f</sup>       | Back Window (Encap)(Slider)(Solar) (OE, Assembly, 3 Piece, Manual) .....                                 | 18.5x65.5 |
| DB11523 <sup>i</sup>       | Back Window (Encap)(Heated)(Solar) (Stationary, 2-Pin Connector) (09)(11) .....                          | 17.0x64.0 |
| DB11522 <sup>e</sup>       | Back Window (Encap)(Solar) (Stationary) .....  | 17.0x64.0 |

- <sup>a</sup> May Require Two Person Installation
- <sup>b</sup> Not On Production Vehicles
- <sup>c</sup> On Production Vehicles
- <sup>d</sup> Urethane,Dam,Primer - 1.5 Tubes
- <sup>e</sup> Foam Core Butyl Tape - Quantity 1.5
- <sup>f</sup> Foam Core Butyl Tape - Quantity 2
- <sup>g</sup> Urethane,Dam,Primer - 2.5 Tubes
- <sup>h</sup> Fast-Cure Urethane/Dam/Primer - Quantity 2.5
- <sup>i</sup> Foam Core Butyl Tape (09-11) - Quantity 1.5

**F Series F150 4 Door Crew Cab ..... 2006-2008**

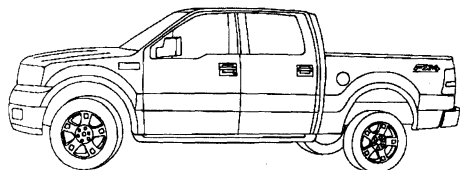

**F Series (cont.)**

|                            |  |           |
|----------------------------|--|-----------|
| DW01621 <sup>a c f g</sup> | Windshield (Solar) (W/Third Visor Frit, W/Harley Davidson Logo) .....  | 37.2x70.7 |
| DW01551 <sup>a d f g</sup> | Windshield (Solar) (W/Third Visor Frit, Aftermarket) .....   | 37.2x70.7 |
| DW01548 <sup>a d f g</sup> | Windshield (Solar) (W/Third Visor Frit) .....  | 37.2x70.7 |
| DW01529 <sup>a c f g</sup> | Windshield (Solar) (W/Third Visor Frit, 'F150' in 3rd Visor Frit) .....  | 37.2x70.7 |
| DD10462-63                 | Door F/R-L (Solar) .....   | 26.4x27.1 |
| DD10466-67                 | Door R/R-L (Solar) .....   | 26.4x27.7 |
| DR09299                    | Roof (Solar) .....   | 18.0x40.0 |
| DB10767                    | Back Window C (Solar) (OE, Movable, Manual) .....  | 15.0x15.2 |
| DB10672                    | Back Window C (Solar) (OE, Power, Movable) .....   | 14.9x15.2 |
| DY90114 <sup>i</sup>       | Back Window (Slider)(Solar) (Aftermarket, 1 Panel Flush Fit, Manual) .....                                       | 18.5x65.5 |
| DY90110 <sup>i</sup>       | Back Window (Encap)(Slider)(Solar) (Black Frame, Aftermarket, Power, Bolt-In, 3 Panel Encapsulated) ...          | 18.5x65.5 |
| DY90109 <sup>i</sup>       | Back Window (Encap)(Slider)(Solar) (Black Frame, Aftermarket, Manual, Bolt-In, 3 Panel Encapsulated) .           | 18.5x65.5 |
| DB11133 <sup>b c i</sup>   | Back Window (Encap)(Slider)(Solar) (OE, Manual & Power, W/O Center Sliding Glass, W/O Motor, Sub-Assembly) ..... | 18.5x65.5 |
| DB10951 <sup>i</sup>       | Back Window (Encap)(Slider)(Solar) (OE, Assembly, Power, 3 Piece) .....  | 18.5x65.5 |
| DB10474 <sup>i</sup>       | Back Window (Encap)(Slider)(Solar) (OE, Assembly, 3 Piece, Manual) .....   | 18.5x65.5 |
| DB10473 <sup>h</sup>       | Back Window (Encap)(Heated)(Solar) (Stationary) ...  | 17.0x64.0 |
| DB10472 <sup>h</sup>       | Back Window (Encap)(Solar) (Stationary) .....  | 17.0x64.0 |

- <sup>a</sup> May Require Two Person Installation
- <sup>b</sup> When Replacing a Power Slider, Plastic Insert # 4L3Z 15422B68 AA in the Lower Glass Run Channel Must Be Removed
- <sup>c</sup> Does Not Come With Center Slider
- <sup>d</sup> Not On Production Vehicles
- <sup>e</sup> On Production Vehicles
- <sup>f</sup> Urethane,Dam,Primer - 2 Tubes
- <sup>g</sup> Fast-Cure Urethane/Dam/Primer - Quantity 2
- <sup>h</sup> Foam Core Butyl Tape - Quantity 1.5
- <sup>i</sup> Foam Core Butyl Tape - Quantity 2

|  |
|--|
| <b>F Series F350 4 Door Crew Cab ..... 2006-2007</b> |
| <b>F Series F650 4 Door Crew Cab ..... 2006-2007</b> |
| <b>F Series F450 4 Door Crew Cab ..... 2006-2007</b> |
| <b>F Series F750 4 Door Crew Cab ..... 2006-2007</b> |
| <b>F Series F550 4 Door Crew Cab ..... 2006-2007</b> |
| <b>F Series F250 4 Door Crew Cab ..... 2006-2007</b> |

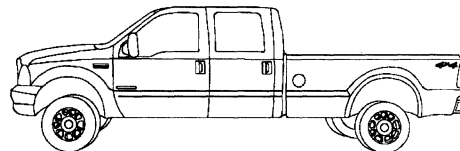

|                              |   |           |
|------------------------------|---|-----------|
| DW01538 <sup>a c d e</sup>   | Windshield (Solar) (W/Harley Davidson Logo) .....   | 34.9x68.9 |
| DW01537 <sup>a b c d e</sup> | Windshield (Solar) (W/Third Visor Frit, Aftermarket) .....  | 34.9x68.9 |
| DW01522 <sup>a c d e</sup>   | Windshield (Solar) ("Super Duty" in 3rd Visor Frit) ..  | 34.9x68.9 |
| DD10638                      | Door F/L (Solar) .....  | 26.4x35.9 |
| DD09327                      | Door F/R (Solar) .....  | 26.4x35.9 |
| DD09329-30                   | Door R/R-L (Solar) .....  | 24.0x26.5 |
| DR09299                      | Roof (Solar) .....  | 18.0x40.0 |
| DB11201                      | Back Window C (Slider)(Solar) (OE, Power, Movable) .....  | 15.4x18.1 |
| DB10803                      | Back Window C (Solar) (OE, Power, Movable, W/Motor & Cable) .....                                     | 15.4x18.1 |
| DB09410                      | Back Window C (Slider)(Solar) (OE, Movable, Manual) .....   | 15.4x18.1 |
| DY90101                      | Back Window (Encap)(Slider) (Black Frame, Aftermarket, Gasket Set, Manual, 3 Panel Encapsulated) .... | 18.5x64.6 |
| DY90094                      | Back Window (Encap)(Slider) (Black Frame, Aftermarket, 4 Panel Encapsulated, Gasket Set, Manual) .... | 18.5x64.6 |

| <b>F Series</b> |   | <b>(cont.)</b> |
|-----------------|---|----------------|
| DY90085         | Back Window (Encap)(Slider)(Solar) (3 Piece Assembly, Aftermarket, Power, Gasket Set) | 18.5x64.6      |
| DY90084         | Back Window (Encap)(Slider)(Solar) (3 Piece Assembly, Aftermarket, Gasket Set)        | 18.5x64.6      |
| DB10840         | Back Window (Slider)(Solar) (OE, Assembly, 3 Piece)                                   | 18.5x64.6      |
| DB10802         | Back Window (Slider)(Solar) (OE, Assembly, Power, 3 Piece)                            | 18.5x64.6      |
| DB09333         | Back Window (Solar) (Stationary)  | 18.5x64.6      |

<sup>a</sup> May Require Two Person Installation  
<sup>b</sup> Not On Production Vehicles  
<sup>c</sup> On Production Vehicles  
<sup>d</sup> Urethane,Dam,Primer - 2 Tubes  
<sup>e</sup> Fast-Cure Urethane/Dam/Primer - Quantity 2

**Fiesta 4 Door Hatchback..... 2011**

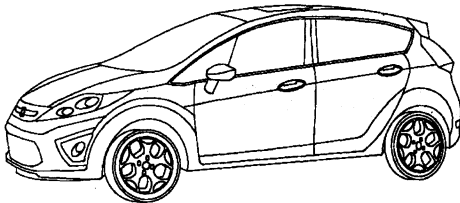

|                          |   |           |
|--------------------------|---|-----------|
| DW01884 <sup>a c d</sup> | Windshield (Solar) (W/Third Visor Frit, Aftermarket)          | 41.0x53.0 |
| DW01837 <sup>b c d</sup> | Windshield (Solar) (W/Third Visor Frit, Acoustic Inter-layer) | 41.0x53.0 |
| DD11797-98               | Door F/R-L (Solar)  | 21.7x36.3 |
| DD11806-07               | Door R/R-L (Solar)  | 20.0x28.0 |
| DQ11810-11 <sup>f</sup>  | Quarter R-L (Encap)(Solar) (Chrome Moulding)                  | 10.4x11.9 |
| DQ11808-09 <sup>f</sup>  | Quarter R-L (Encap)(Solar) (Black Moulding)                   | 10.4x11.9 |
| DV11795-96 <sup>f</sup>  | Vent F/R-L (Encap)(Solar) (Chrome Moulding)                   | 12.0x17.5 |
| DV11793-94 <sup>f</sup>  | Vent F/R-L (Encap)(Solar) (Black Moulding)                    | 12.0x17.5 |
| DB11812 <sup>e</sup>     | Back Window (Heated)(Solar)                                   | 18.5x47.6 |

<sup>a</sup> Not On Production Vehicles  
<sup>b</sup> On Production Vehicles  
<sup>c</sup> Urethane,Dam,Primer - 2 Tubes  
<sup>d</sup> Fast-Cure Urethane/Dam/Primer - Quantity 2  
<sup>e</sup> Urethane,Dam,Primer - 1.5 Tubes  
<sup>f</sup> Urethane,Dam,Primer - 1 Tube

**Fiesta 4 Door Hatchback (MEXICO Only)..... 2006**

|                         |   |           |
|-------------------------|---|-----------|
| FW02401 <sup>a b</sup>  | Windshield (HUD)(Solar) (Mexico Only)       | 39.0x53.7 |
| FD22014-15              | Door F/R-L (Mexico Only)                    | 21.2x34.0 |
| FD22016-17              | Door R/R-L (Mexico Only)                    | 20.3x26.9 |
| FQ22018-19 <sup>d</sup> | Quarter R-L (Mexico Only)                   | 14.2x14.8 |
| FB22021 <sup>c</sup>    | Back Window (1 Holes) (Mexico Only)         | 17.5x47.0 |
| FB22020 <sup>c</sup>    | Back Window (Heated)(1 Holes) (Mexico Only) | 17.5x47.0 |

<sup>a</sup> Urethane,Dam,Primer - 2 Tubes  
<sup>b</sup> Fast-Cure Urethane/Dam/Primer - Quantity 2  
<sup>c</sup> Urethane,Dam,Primer - 1.5 Tubes  
<sup>d</sup> Urethane,Dam,Primer - 1 Tube

**Fiesta 4 Door Sedan..... 2011**

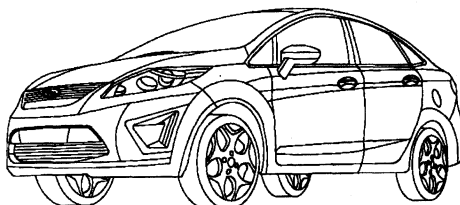

| <b>Fiesta</b>            |   | <b>(cont.)</b> |
|--------------------------|---|----------------|
| DW01884 <sup>a c d</sup> | Windshield (Solar) (W/Third Visor Frit, Aftermarket)          | 41.0x53.0      |
| DW01837 <sup>b c d</sup> | Windshield (Solar) (W/Third Visor Frit, Acoustic Inter-layer) | 41.0x53.0      |
| DD11797-98               | Door F/R-L (Solar)  | 21.7x36.3      |
| DD11799-00               | Door R/R-L (Solar)  | 20.7x28.5      |
| DQ11803-04 <sup>f</sup>  | Quarter R-L (Encap)(Solar) (Chrome Moulding)                  | 11.2x14.7      |
| DQ11801-02 <sup>f</sup>  | Quarter R-L (Encap)(Solar) (Black Moulding)                   | 11.2x14.7      |
| DV11795-96 <sup>f</sup>  | Vent F/R-L (Encap)(Solar) (Chrome Moulding)                   | 12.0x17.5      |
| DV11793-94 <sup>f</sup>  | Vent F/R-L (Encap)(Solar) (Black Moulding)                    | 12.0x17.5      |
| DB11805 <sup>e</sup>     | Back Window (Heated)(Solar)                                   | 30.9x42.2      |

<sup>a</sup> Not On Production Vehicles  
<sup>b</sup> On Production Vehicles  
<sup>c</sup> Urethane,Dam,Primer - 2 Tubes  
<sup>d</sup> Fast-Cure Urethane/Dam/Primer - Quantity 2  
<sup>e</sup> Urethane,Dam,Primer - 1.5 Tubes  
<sup>f</sup> Urethane,Dam,Primer - 1 Tube

**Fiesta 4 Door Sedan (MEXICO Only)..... 2006-2010**

|                        |  |           |
|------------------------|--|-----------|
| FW02401 <sup>a b</sup> | Windshield (HUD)(Solar) (Mexico Only)      | 39.0x53.7 |
| FD22014-15             | Door F/R-L (Mexico Only)                   | 21.2x34.0 |
| FD22016-17             | Door R/R-L (Mexico Only)                   | 20.3x26.9 |
| FQ22981-82             | Quarter R-L (Mexico Only)                  | 14.2x14.8 |
| FB23479 <sup>c</sup>   | Back Window (Heated) (Mexico Only) (07-10) |           |
| FB22983 <sup>c</sup>   | Back Window (Heated) (Mexico Only) (06)    | 17.5x47.0 |

<sup>a</sup> Urethane,Dam,Primer - 2 Tubes  
<sup>b</sup> Fast-Cure Urethane/Dam/Primer - Quantity 2  
<sup>c</sup> Urethane,Dam,Primer - 1.5 Tubes

**Five Hundred 4 Door Sedan..... 2006-2007**

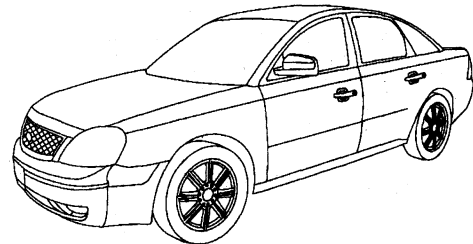

|                         |                             |           |
|-------------------------|-----------------------------|-----------|
| DW01568 <sup>a b</sup>  | Windshield (Solar)          | 38.9x63.7 |
| DD10683-84              | Door F/R-L (Solar)          | 22.6x34.3 |
| DD10685-86              | Door R/R-L (Solar)          | 22.2x30.3 |
| DR10690                 | Roof (Solar)                | 17.8x33.5 |
| DQ10687-88 <sup>c</sup> | Quarter R-L (Encap)(Solar)  | 14.0x24.3 |
| DB10689 <sup>a</sup>    | Back Window (Heated)(Solar) | 34.9x55.4 |

<sup>a</sup> Urethane,Dam,Primer - 2 Tubes  
<sup>b</sup> Fast-Cure Urethane/Dam/Primer - Quantity 2  
<sup>c</sup> Urethane,Dam,Primer - 1 Tube

**Flex 4 Door Utility..... 2009-2011**

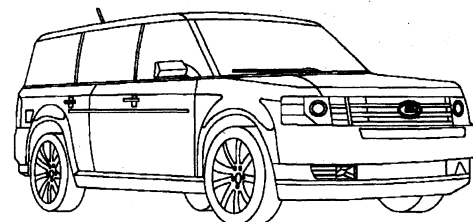

|                          |  |           |
|--------------------------|--|-----------|
| DW01864 <sup>a c d</sup> | Windshield (Solar) (W/Third Visor Frit, Aftermarket) | 35.0x65.4 |
|--------------------------|--|-----------|

**Flex (cont.)**

|  |           |
|--|-----------|
| DW01725 <sup>b c d</sup> Windshield (Solar) (W/Third Visor Frit, Acoustic Inter-layer) ..... | 35.0x65.4 |
| DD11551-52 Door F/R-L (Solar) (Laminated, Acoustic Interlayer) ..                            | 23.2x35.2 |
| DD11450-51 Door F/R-L (2 Holes)(Solar) .....   | 23.2x35.2 |
| DD11452-53 Door R/R-L (2 Holes)(Solar) .....   | 22.6x27.9 |
| DR10682 Roof F (Solar) (Assembly, Movable) .....   | 17.8x33.5 |
| DR11460 <sup>c</sup> Roof R (Solar) (Stationary) .....                                       | 39.4x49.7 |
| DQ11461-62 <sup>e</sup> Quarter R-L (Solar) .....  | 18.2x37.5 |
| DV11456-57 Vent R/R-L (Solar) .....  | 9.1x18.2  |
| DB11465 <sup>e</sup> Back Window (Heated)(1 Holes)(Solar) (W/Wiper) ...                      | 18.1x55.0 |

<sup>a</sup> Not On Production Vehicles  
<sup>b</sup> On Production Vehicles  
<sup>c</sup> Urethane,Dam,Primer - 2 Tubes  
<sup>d</sup> Fast-Cure Urethane/Dam/Primer - Quantity 2  
<sup>e</sup> Urethane,Dam,Primer - 1.5 Tubes

**Focus 2 Door Coupe..... 2008-2011**

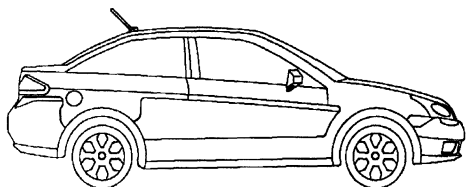

|  |           |
|--|-----------|
| DW01859 <sup>a c d</sup> Windshield (Solar) (W/Third Visor Frit, Aftermarket)                | 38.0x57.6 |
| DW01694 <sup>b c d</sup> Windshield (Solar) (W/Third Visor Frit, Acoustic Inter-layer) ..... | 38.0x57.6 |
| DD11347-48 Door F/R-L (Solar) .....  | 21.5x42.2 |
| DR10635 Roof (Encap)(Solar) (Power) .....  | 16.3x32.0 |
| DQ11349-50 <sup>f</sup> Quarter R-L (Solar) .....  | 16.3x37.0 |
| DB11351 <sup>e</sup> Back Window (Heated)(Solar) .....                                       | 29.2x50.4 |

<sup>a</sup> Not On Production Vehicles  
<sup>b</sup> On Production Vehicles  
<sup>c</sup> Urethane,Dam,Primer - 2 Tubes  
<sup>d</sup> Fast-Cure Urethane/Dam/Primer - Quantity 2  
<sup>e</sup> Urethane,Dam,Primer - 1.5 Tubes  
<sup>f</sup> Urethane,Dam,Primer - 1 Tube

**Focus 2 Door Hatchback (MEXICO Only)..... 2007-2010**

|  |  |
|--|--|
| DW01777 <sup>a b</sup> Windshield (Heated)(Solar) (W/Third Visor Frit, Mexico Only, Solar Coated, Rain Sensor) ..... |  |
| DW01776 <sup>a b</sup> Windshield (Solar) (W/Third Visor Frit, Mexico Only, Solar Coated) .....                      |  |
| DW01775 <sup>a b</sup> Windshield (Heated)(Solar) (W/Third Visor Frit, Mexico Only, Rain Sensor) .....               |  |
| DW01774 <sup>a b</sup> Windshield (Heated)(Solar) (W/Third Visor Frit, Mexico Only) .....                            |  |
| DW01766 <sup>a b</sup> Windshield (Solar) (W/Third Visor Frit, Mexico Only, Rain Sensor) .....                       |  |
| DW01757 <sup>a b</sup> Windshield (Solar) (W/Third Visor Frit, Mexico Only) .....                                    |  |
| DD11581-82 Door F/R-L (Solar) (Mexico Only) .....  |  |
| DQ11583-84 <sup>c</sup> Quarter R-L (Solar) (Mexico Only) .....  |  |
| DB11585 <sup>c</sup> Back Window (Heated)(Solar) (Mexico Only) .....   |  |

<sup>a</sup> Urethane,Dam,Primer - 2 Tubes  
<sup>b</sup> Fast-Cure Urethane/Dam/Primer - Quantity 2  
<sup>c</sup> Urethane,Dam,Primer - 1.5 Tubes

**Focus 2 Door Hatchback..... 2006-2007**

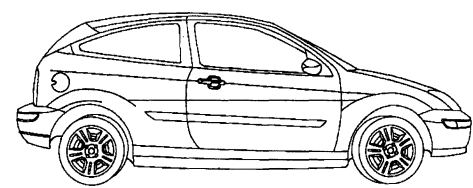

|  |           |
|--|-----------|
| DW01459 <sup>a b</sup> Windshield (Solar) .....                        | 38.0x57.6 |
| DD09669-70 Door F/R-L (Solar) .....                                    | 21.5x42.2 |
| DR09916 Roof (Encap)(Solar) .....                                      | 16.0x32.8 |
| DQ09671-72 <sup>c</sup> Quarter R-L (Solar) .....                      | 17.4x43.1 |
| DB10119 <sup>c</sup> Back Window (Heated)(1 Holes)(Solar) (High Amp) . | 24.4x45.1 |

<sup>a</sup> Urethane,Dam,Primer - 2 Tubes  
<sup>b</sup> Fast-Cure Urethane/Dam/Primer - Quantity 2  
<sup>c</sup> Urethane,Dam,Primer - 1.5 Tubes

**Focus 4 Door Hatchback..... 2012**

|  |           |
|--|-----------|
| DW01876 <sup>a b</sup> Windshield (Solar) (Acoustic Interlayer) .....      | 43.0x56.0 |
| DW01875 <sup>a b d</sup> Windshield (Solar) (Rain Sensor) .....            | 43.0x56.0 |
| DW01874 <sup>a b</sup> Windshield (Solar) .....                            | 43.0x56.0 |
| DD11866-67 Door F/R-L (Solar) .....  | 21.3x37.1 |
| DD11868-69 Door R/R-L (Solar) .....  | 20.5x26.9 |
| DQ11877-78 <sup>e</sup> Quarter R-L (Encap)(Solar) (Chrome Moulding) ..... | 13.3x15.4 |
| DQ11875-76 <sup>e</sup> Quarter R-L (Encap)(Solar) (Black Moulding) .....  | 13.3x15.4 |
| DB11879 <sup>c</sup> Back Window (Heated)(1 Holes)(Solar) (W/Wiper) ...    | 21.6x49.6 |

<sup>a</sup> Urethane,Dam,Primer - 2 Tubes  
<sup>b</sup> Fast-Cure Urethane/Dam/Primer - Quantity 2  
<sup>c</sup> Urethane,Dam,Primer - 1.5 Tubes  
<sup>d</sup> Rain Sensor Kit  
<sup>e</sup> Urethane,Dam,Primer - 1 Tube

**Focus 4 Door Hatchback..... 2006-2007**

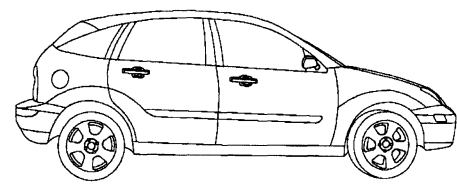

|  |           |
|--|-----------|
| DW01459 <sup>a b</sup> Windshield (Solar) .....                        | 38.0x57.6 |
| DD09522-23 Door F/R-L (Solar) .....                                    | 21.7x34.3 |
| DD09524-25 Door R/R-L (Solar) .....                                    | 21.0x27.5 |
| DR10635 Roof (Encap)(Solar) (Power) .....                              | 16.3x32.0 |
| DQ10013-14 <sup>d</sup> Quarter R-L (Solar) .....                      | 15.6x25.7 |
| DB10119 <sup>c</sup> Back Window (Heated)(1 Holes)(Solar) (High Amp) . | 24.4x45.1 |

<sup>a</sup> Urethane,Dam,Primer - 2 Tubes  
<sup>b</sup> Fast-Cure Urethane/Dam/Primer - Quantity 2  
<sup>c</sup> Urethane,Dam,Primer - 1.5 Tubes  
<sup>d</sup> Urethane,Dam,Primer - 1 Tube

**Focus 4 Door Sedan..... 2012**

|  |           |
|--|-----------|
| DW01876 <sup>a b</sup> Windshield (Solar) (Acoustic Interlayer) .....      | 43.0x56.0 |
| DW01875 <sup>a b d</sup> Windshield (Solar) (Rain Sensor) .....            | 43.0x56.0 |
| DW01874 <sup>a b</sup> Windshield (Solar) .....                            | 43.0x56.0 |
| DD11866-67 Door F/R-L (Solar) .....  | 21.3x37.1 |
| DD11868-69 Door R/R-L (Solar) .....  | 20.5x26.9 |
| DQ11872-73 <sup>e</sup> Quarter R-L (Encap)(Solar) (Chrome Moulding) ..... | 11.9x19.1 |
| DQ11870-71 <sup>e</sup> Quarter R-L (Encap)(Solar) (Black Moulding) .....  | 11.9x19.1 |

**Focus (cont.)**

**DB11874<sup>c</sup>** Back Window (Heated)(Solar) ..... 31.4x47.4

<sup>a</sup> Urethane,Dam,Primer - 2 Tubes  
<sup>b</sup> Fast-Cure Urethane/Dam/Primer - Quantity 2  
<sup>c</sup> Urethane,Dam,Primer - 1.5 Tubes  
<sup>d</sup> Rain Sensor Kit  
<sup>e</sup> Urethane,Dam,Primer - 1 Tube

**Focus 4 Door Sedan ..... 2008-2011**

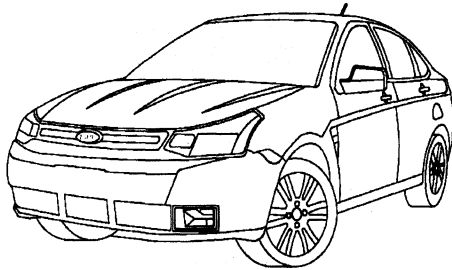

**DW01859<sup>a c d</sup>** Windshield (Solar) (W/Third Visor Frit, Aftermarket) ..... 38.0x57.6

**DW01694<sup>b c d</sup>** Windshield (Solar) (W/Third Visor Frit, Acoustic Inter-layer) ..... 38.0x57.6

**DD11352-53** Door F/R-L (Solar) ..... 21.7x34.5

**DD11367-68** Door R/R-L (Solar) ..... 21.0x27.5

**DR10635** Roof (Encap)(Solar) (Power) ..... 16.3x32.0

**DQ11354-55<sup>f</sup>** Quarter R-L (Solar) ..... 12.3x17.9

**DB11351<sup>e</sup>** Back Window (Heated)(Solar) ..... 29.2x50.4

<sup>a</sup> Not On Production Vehicles  
<sup>b</sup> On Production Vehicles  
<sup>c</sup> Urethane,Dam,Primer - 2 Tubes  
<sup>d</sup> Fast-Cure Urethane/Dam/Primer - Quantity 2  
<sup>e</sup> Urethane,Dam,Primer - 1.5 Tubes  
<sup>f</sup> Urethane,Dam,Primer - 1 Tube

**Focus 4 Door Sedan (MEXICO Only) ..... 2007-2010**

**DW01777<sup>a b</sup>** Windshield (Heated)(Solar) (W/Third Visor Frit, Mexico Only, Solar Coated, Rain Sensor) ..... 38.0x57.6

**DW01776<sup>a b</sup>** Windshield (Solar) (W/Third Visor Frit, Mexico Only, Solar Coated) ..... 38.0x57.6

**DW01775<sup>a b</sup>** Windshield (Heated)(Solar) (W/Third Visor Frit, Mexico Only, Rain Sensor) ..... 38.0x57.6

**DW01774<sup>a b</sup>** Windshield (Heated)(Solar) (W/Third Visor Frit, Mexico Only) ..... 38.0x57.6

**DW01766<sup>a b</sup>** Windshield (Solar) (W/Third Visor Frit, Mexico Only, Rain Sensor) ..... 38.0x57.6

**DW01757<sup>a b</sup>** Windshield (Solar) (W/Third Visor Frit, Mexico Only) ..... 38.0x57.6

**DD11525-26** Door F/R-L (Solar) (Mexico Only) ..... 21.7x34.5

**DD11527-28** Door R/R-L (Solar) (Mexico Only) ..... 21.0x27.5

**DQ11529-30<sup>c</sup>** Quarter R-L (Solar) (Mexico Only) ..... 12.3x17.9

**DB11531<sup>c</sup>** Back Window (Heated)(Solar) (Mexico Only) ..... 29.2x50.4

<sup>a</sup> Urethane,Dam,Primer - 2 Tubes  
<sup>b</sup> Fast-Cure Urethane/Dam/Primer - Quantity 2  
<sup>c</sup> Urethane,Dam,Primer - 1.5 Tubes

**Focus 4 Door Sedan ..... 2006-2007**

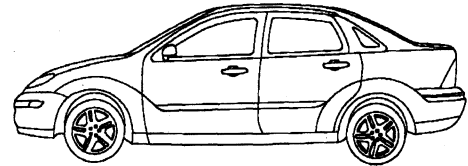

**DW01459<sup>a b</sup>** Windshield (Solar) ..... 38.0x57.6

**DD09522-23** Door F/R-L (Solar) ..... 21.7x34.3

**DD09524-25** Door R/R-L (Solar) ..... 21.0x27.5

**DR10635** Roof (Encap)(Solar) (Power) ..... 16.3x32.0

**DQ09528-29<sup>d</sup>** Quarter R-L (Solar) ..... 11.1x12.0

**DB10628<sup>c</sup>** Back Window (Heated)(Solar) ..... 28.0x49.8

<sup>a</sup> Urethane,Dam,Primer - 2 Tubes  
<sup>b</sup> Fast-Cure Urethane/Dam/Primer - Quantity 2  
<sup>c</sup> Urethane,Dam,Primer - 1.5 Tubes  
<sup>d</sup> Urethane,Dam,Primer - 1 Tube

**Focus 4 Door Station Wagon ..... 2006-2007**

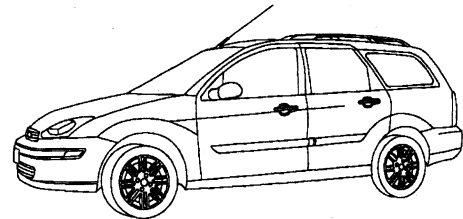

**DW01459<sup>a b</sup>** Windshield (Solar) ..... 38.0x57.6

**DD09522-23** Door F/R-L (Solar) ..... 21.7x34.3

**DD09526-27** Door R/R-L (Solar) ..... 21.2x26.7

**DR10635** Roof (Encap)(Solar) (Power) ..... 16.3x32.0

**DQ09530-31<sup>c</sup>** Quarter R-L (Solar) ..... 17.1x38.3

**DB10121<sup>c</sup>** Back Window (Heated)(1 Holes)(Solar) (W/Wiper, High Amp) ..... 18.1x49.4

<sup>a</sup> Urethane,Dam,Primer - 2 Tubes  
<sup>b</sup> Fast-Cure Urethane/Dam/Primer - Quantity 2  
<sup>c</sup> Urethane,Dam,Primer - 1.5 Tubes

**Freestar Mini Van ..... 2006-2007**

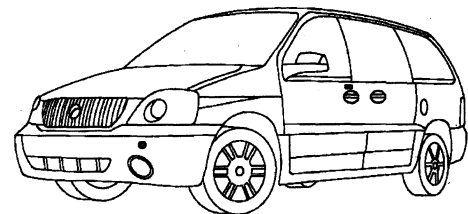

**DW01527<sup>a b c</sup>** Windshield (Solar) (W/Third Visor Frit) ..... 42.5x64.3

**DD10206-07** Door F/R-L (Solar) ..... 26.2x35.9

**DD10815<sup>d</sup>** Door R/L (Solar) (Sliding Cargo Door) ..... 24.0x40.2

**DD10814<sup>d</sup>** Door R/R (Solar) (Sliding Cargo Door) ..... 24.0x44.8

**DQ10817** Quarter L (Solar) (W/LH Sliding Door, Movable) ..... 21.7x40.6

**DQ10816** Quarter R (Ant)(Solar) (Movable) ..... 21.5x35.2

**DB10511<sup>b</sup>** Back Window (Heated)(Solar) ..... 28.5x58.7

<sup>a</sup> May Require Two Person Installation  
<sup>b</sup> Urethane,Dam,Primer - 2 Tubes  
<sup>c</sup> Fast-Cure Urethane/Dam/Primer - Quantity 2  
<sup>d</sup> Urethane,Dam,Primer - 1.5 Tubes

**Freestyle 4 Door Utility..... 2006-2007**

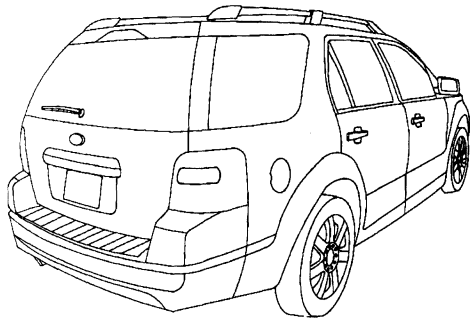

|   |           |
|---|-----------|
| DW01612 <sup>a b c</sup> Windshield (Encap)(Solar) (W/Third Visor Frit) ..... | 38.5x62.6 |
| DD10673-74 Door F/R-L (Solar) .....   | 23.1x36.8 |
| DD10675-76 Door R/R-L (Solar) .....   | 22.4x28.3 |
| DR10682 Roof F (Solar) (Assembly, Movable) .....                              | 17.8x33.5 |
| DQ10679-80 <sup>d</sup> Quarter R-L (Solar) .....                             | 18.7x39.1 |
| DV10677-78 Vent R/R-L (Solar) .....   | 9.4x17.7  |
| DB10681 <sup>d</sup> Back Window (Heated)(1 Holes)(Solar) (W/Wiper) ...       | 20.9x54.9 |

<sup>a</sup> Lower Encapsulation changed drastically from DW01567  
<sup>b</sup> Urethane,Dam,Primer - 2 Tubes  
<sup>c</sup> Fast-Cure Urethane/Dam/Primer - Quantity 2  
<sup>d</sup> Urethane,Dam,Primer - 1.5 Tubes

**Fusion 4 Door Sedan..... 2006-2011**

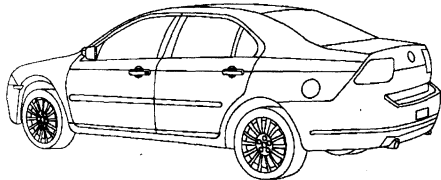

|  |           |
|--|-----------|
| DW01829 <sup>a d e</sup> Windshield (Solar) (W/Third Visor Frit, Acoustic Inter-layer, Rain Sensor) (11) ..... | 42.0x58.5 |
| DW01782 <sup>a d e</sup> Windshield (Solar) (W/Third Visor Frit, Acoustic Inter-layer) (10-11) .....           | 42.0x58.5 |
| DW01622 <sup>b c d e</sup> Windshield (Solar) (W/Third Visor Frit) .....                                       | 42.0x58.5 |
| DD10919-20 Door F/R-L (Solar) .....  | 22.0x39.0 |
| DD10923-24 Door R/R-L (Solar) .....  | 20.3x27.0 |
| DR11738 Roof (Solar) (From 11/04/2008) (09-11) .....   | 18.9x32.5 |
| DR10981 Roof (Solar) (To 11/04/2008) (06-09) .....   | 18.9x32.5 |
| DV10925-26 Vent R/R-L (Solar) .....  | 9.8x11.3  |
| DB11615 <sup>d</sup> Back Window (Heated)(Solar) (10-11) .....   | 32.4x51.1 |
| DB11179 <sup>d</sup> Back Window (Heated)(Solar) (07-09) .....   | 32.4x51.1 |
| DB10927 <sup>d</sup> Back Window (Ant)(Heated)(Solar) (4 Leads) (06) .....                                     | 32.4x51.1 |

<sup>a</sup> On Production Vehicles  
<sup>b</sup> Not On Production Vehicles 2010-2011  
<sup>c</sup> On Production Vehicles 2006-2009  
<sup>d</sup> Urethane,Dam,Primer - 2 Tubes  
<sup>e</sup> Fast-Cure Urethane/Dam/Primer - Quantity 2

**GT 2 Door Coupe..... 2006-2007**

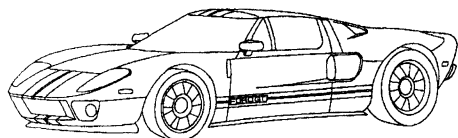

|  |           |
|--|-----------|
| DW01644 <sup>a b</sup> Windshield (Ant)(Solar) ..... | 35.1x67.5 |
|--|-----------|

**GT (cont.)**

|  |           |
|--|-----------|
| DD10693-94 Door F/R-L (Solar) .....            | 17.3x26.5 |
| DP10724 Partition (Sealed Unit) .....          | 9.1x39.2  |
| DV10691-92 Vent F/R-L (Solar) .....            | 15.7x16.1 |
| DB10695 <sup>c</sup> Back Window (Solar) ..... | 23.8x37.0 |

<sup>a</sup> Urethane,Dam,Primer - 2 Tubes  
<sup>b</sup> Fast-Cure Urethane/Dam/Primer - Quantity 2  
<sup>c</sup> Urethane,Dam,Primer - 1.5 Tubes

**Grand Marquis 4 Door Sedan ..... 2006-2008 (CANADA Only)**

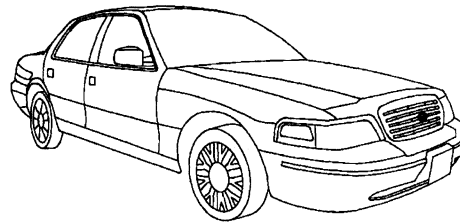

|  |           |
|--|-----------|
| DW01506 <sup>a b</sup> Windshield (Solar) (W/Third Visor Frit) ..... | 33.1x65.0 |
| DD10225-26 Door F/R-L (Solar) (Laminated) .....                      | 21.9x34.7 |
| DD08626-27 Door F/R-L (2 Holes)(Solar) .....                         | 23.0x34.8 |
| DD10227-28 Door R/R-L (Solar) (Laminated) .....                      | 20.1x21.9 |
| DD09914-15 Door R/R-L (2 Holes)(Solar) (LWB) .....                   | 23.4x26.1 |
| DD08636-37 Door R/R-L (2 Holes)(Solar) .....                         | 20.2x23.0 |
| DR10797 Roof (Solar) (Assembly) .....                                | 18.1x31.6 |
| DV10039-40 Vent R/R-L (Solar) (Taxi, Assembly, Police, LWB) .....    | 13.0x19.3 |
| DV08638-39 Vent R/R-L (Solar) .....                                  | 13.0x19.3 |
| DB10949 <sup>a</sup> Back Window (Ant)(Heated)(Solar) .....          | 23.8x61.9 |

<sup>a</sup> Urethane,Dam,Primer - 2 Tubes  
<sup>b</sup> Fast-Cure Urethane/Dam/Primer - Quantity 2

**Ikon 4 Door Sedan (MEXICO Only)..... 2006-2008**

|   |           |
|---|-----------|
| DW01476 <sup>a b</sup> Windshield (Mexico Only) .....         | 29.5x53.5 |
| DD10105-06 Door F/R-L (Mexico Only) .....                     | 20.5x30.0 |
| DD10107-08 Door R/R-L (Mexico Only) .....                     | 19.0x21.3 |
| DV10109-10 Vent R/R-L (Mexico Only) .....                     | 11.5x14.5 |
| DB10111 <sup>c</sup> Back Window (Heated) (Mexico Only) ..... | 26.0x45.0 |

<sup>a</sup> Urethane,Dam,Primer - 2 Tubes  
<sup>b</sup> Fast-Cure Urethane/Dam/Primer - Quantity 2  
<sup>c</sup> Urethane,Dam,Primer - 1.5 Tubes

**Ka 2 Door Hatchback (MEXICO Only)..... 2006-2008**

|   |           |
|---|-----------|
| DW01475 <sup>a b</sup> Windshield (Mexico Only) .....         | 31.5x49.5 |
| DD10100-01 Door F/R-L (Mexico Only) .....                     | 20.0x38.5 |
| DQ10102-03 <sup>c</sup> Quarter R-L (Mexico Only) .....       | 17.5x22.5 |
| DB10637 <sup>a</sup> Back Window (Heated) (Mexico Only) ..... | 19.0x52.0 |

<sup>a</sup> Urethane,Dam,Primer - 1.5 Tubes  
<sup>b</sup> Fast-Cure Urethane/Dam/Primer - Quantity 1.5  
<sup>c</sup> Urethane,Dam,Primer - 1 Tube

**Lobo 2 Door Extended Cab (MEXICO Only)..... 2009-2010**

|  |           |
|--|-----------|
| DW01797 <sup>a c g h</sup> Windshield (Solar) (W/Third Visor Frit, W/Harley Davidson Logo) (10) .....      | 37.3x70.8 |
| DW01749 <sup>a c g h</sup> Windshield (Solar) (W/Third Visor Frit, 'F150' in 3rd Visor Frit) (10) .....    | 37.3x70.8 |
| DW01748 <sup>a c g h</sup> Windshield (Solar) (W/Third Visor Frit, Acoustic Interlayer, Rain Sensor) ..... | 37.3x70.8 |
| DW01747 <sup>a b g h</sup> Windshield (Solar) (W/Third Visor Frit) .....                                   | 37.3x70.8 |
| DD10464-65 Door F/R-L (Solar) .....  | 26.8x33.4 |
| DR09299 Roof (Solar) (09) .....  | 18.0x40.0 |



| <i>Lobo</i>            | <i>(cont.)</i>   |
|------------------------|--|
| DQ10470-71             | Quarter R-L (Solar) (Rear Access Door) ..... 16.6x24.9   |
| DB11709                | Back Window C (Heated)(Solar) (OE, Power) (10) ..... 14.9x15.2   |
| DB10767                | Back Window C (Solar) (OE, Movable, Manual) ..... 15.0x15.2  |
| DB10672                | Back Window C (Solar) (OE, Power, Movable) (09) .... 14.9x15.2   |
| DY90114 <sup>f</sup>   | Back Window (Slider)(Solar) (Aftermarket, 1 Panel Flush Fit, Manual) ..... 18.5x65.5                               |
| DY90110 <sup>f</sup>   | Back Window (Encap)(Slider)(Solar) (Black Frame, Aftermarket, Power, Bolt-In, 3 Panel Encapsulated) .... 18.5x65.5 |
| DY90109 <sup>f</sup>   | Back Window (Encap)(Slider)(Solar) (Black Frame, Aftermarket, Manual, Bolt-In, 3 Panel Encapsulated) .. 18.5x65.5  |
| DB11827 <sup>b,f</sup> | Back Window (Encap)(Slider)(Solar) (Assembly, Aftermarket, Power, 3 Piece, W/O Motor) (09) ..... 18.5x65.5         |
| DB11710 <sup>d</sup>   | Back Window (Encap)(Heated)(Solar) (Stationary, 4-Pin Connector) (10) ..... 17.0x64.0                              |
| DB11708 <sup>f</sup>   | Back Window (Encap)(Heated)(Slider)(Solar) (OE, 3 Piece Assembly, Power) (10) ..... 18.5x65.5                      |
| DB11577 <sup>c,f</sup> | Back Window (Encap)(Slider)(Solar) (OE, Assembly, Power, 3 Piece) (09) ..... 18.5x65.5                             |
| DB11576 <sup>f</sup>   | Back Window (Encap)(Slider)(Solar) (OE, Assembly, 3 Piece, Manual) ..... 18.5x65.5                                 |
| DB11523 <sup>e</sup>   | Back Window (Encap)(Heated)(Solar) (Stationary, 2-Pin Connector) (09) ..... 17.0x64.0                              |
| DB11522 <sup>e</sup>   | Back Window (Encap)(Solar) (Stationary) ..... 17.0x64.0  |

**Lobo 2 Door Extended Cab (MEXICO Only) ..... 2006-2008**

|                            |  |
|----------------------------|--|
| DW01551 <sup>a,e,f</sup>   | Windshield (Solar) (W/Third Visor Frit, Aftermarket) 37.2x70.7   |
| DW01548 <sup>a,d,e,f</sup> | Windshield (Solar) (W/Third Visor Frit) ..... 37.2x70.7  |
| DD10464-65                 | Door F/R-L (Solar) ..... 26.8x33.4   |
| DR09299                    | Roof (Solar) ..... 18.0x40.0   |
| DQ10470-71                 | Quarter R-L (Solar) (Rear Access Door) ..... 16.6x24.9   |
| DB10767                    | Back Window C (Solar) (OE, Movable, Manual) ..... 15.0x15.2  |
| DB10672                    | Back Window C (Solar) (OE, Power, Movable) ..... 14.9x15.2   |
| DY90114 <sup>b</sup>       | Back Window (Slider)(Solar) (Aftermarket, 1 Panel Flush Fit, Manual) ..... 18.5x65.5                                       |
| DY90110 <sup>b</sup>       | Back Window (Encap)(Slider)(Solar) (Black Frame, Aftermarket, Power, Bolt-In, 3 Panel Encapsulated) .... 18.5x65.5         |
| DY90109 <sup>b</sup>       | Back Window (Encap)(Slider)(Solar) (Black Frame, Aftermarket, Manual, Bolt-In, 3 Panel Encapsulated) .. 18.5x65.5          |
| DB11133 <sup>b,c,h</sup>   | Back Window (Encap)(Slider)(Solar) (OE, Manual & Power, W/O Center Sliding Glass, W/O Motor, Sub-Assembly) ..... 18.5x65.5 |
| DB10951 <sup>b</sup>       | Back Window (Encap)(Slider)(Solar) (OE, Assembly, Power, 3 Piece) ..... 18.5x65.5  |
| DB10474 <sup>b</sup>       | Back Window (Encap)(Slider)(Solar) (OE, Assembly, 3 Piece, Manual) ..... 18.5x65.5   |
| DB10473 <sup>e</sup>       | Back Window (Encap)(Heated)(Solar) (Stationary) .... 17.0x64.0   |
| DB10472 <sup>e</sup>       | Back Window (Encap)(Solar) (Stationary) ..... 17.0x64.0  |

**Lobo 2 Door Standard Cab (MEXICO Only) ..... 2009-2010**

|                            |  |
|----------------------------|--|
| DW01797 <sup>a,c,g,h</sup> | Windshield (Solar) (W/Third Visor Frit, W/Harley Davidson Logo) (10) ..... 37.3x70.8 |
|----------------------------|--|

| <i>Lobo</i>                | <i>(cont.)</i>  |
|----------------------------|---|
| DW01749 <sup>a,c,g,h</sup> | Windshield (Solar) (W/Third Visor Frit, 'F150' in 3rd Visor Frit) (10) ..... 37.3x70.8                            |
| DW01748 <sup>a,c,g,h</sup> | Windshield (Solar) (W/Third Visor Frit, Acoustic Interlayer, Rain Sensor) ..... 37.3x70.8                         |
| DW01747 <sup>a,b,g,h</sup> | Windshield (Solar) (W/Third Visor Frit) ..... 37.3x70.8   |
| DD10464-65                 | Door F/R-L (Solar) ..... 26.8x33.4  |
| DR09299                    | Roof (Solar) (09) ..... 18.0x40.0   |
| DB11709                    | Back Window C (Heated)(Solar) (OE, Power) (10) ..... 14.9x15.2  |
| DB10767                    | Back Window C (Solar) (OE, Movable, Manual) ..... 15.0x15.2   |
| DB10672                    | Back Window C (Solar) (OE, Power, Movable) (09) .... 14.9x15.2  |
| DY90114 <sup>f</sup>       | Back Window (Slider)(Solar) (Aftermarket, 1 Panel Flush Fit, Manual) ..... 18.5x65.5                              |
| DY90110 <sup>f</sup>       | Back Window (Encap)(Slider)(Solar) (Black Frame, Aftermarket, Power, Bolt-In, 3 Panel Encapsulated) ... 18.5x65.5 |
| DY90109 <sup>f</sup>       | Back Window (Encap)(Slider)(Solar) (Black Frame, Aftermarket, Manual, Bolt-In, 3 Panel Encapsulated) . 18.5x65.5  |
| DB11827 <sup>b,f</sup>     | Back Window (Encap)(Slider)(Solar) (Assembly, Aftermarket, Power, 3 Piece, W/O Motor) (09) ..... 18.5x65.5        |
| DB11710 <sup>d</sup>       | Back Window (Encap)(Heated)(Solar) (Stationary, 4-Pin Connector) (10) ..... 17.0x64.0                             |
| DB11708 <sup>f</sup>       | Back Window (Encap)(Heated)(Slider)(Solar) (OE, 3 Piece Assembly, Power) (10) ..... 18.5x65.5                     |
| DB11577 <sup>c,f</sup>     | Back Window (Encap)(Slider)(Solar) (OE, Assembly, Power, 3 Piece) (09) ..... 18.5x65.5                            |
| DB11576 <sup>f</sup>       | Back Window (Encap)(Slider)(Solar) (OE, Assembly, 3 Piece, Manual) ..... 18.5x65.5                                |
| DB11523 <sup>e</sup>       | Back Window (Encap)(Heated)(Solar) (Stationary, 2-Pin Connector) (09) ..... 17.0x64.0                             |
| DB11522 <sup>e</sup>       | Back Window (Encap)(Solar) (Stationary) ..... 17.0x64.0   |

**Lobo 4 Door Crew Cab (MEXICO Only) ..... 2009-2010**

|                            |   |
|----------------------------|---|
| DW01797 <sup>a,c,g,h</sup> | Windshield (Solar) (W/Third Visor Frit, W/Harley Davidson Logo) (10) ..... 37.3x70.8                              |
| DW01749 <sup>a,c,g,h</sup> | Windshield (Solar) (W/Third Visor Frit, 'F150' in 3rd Visor Frit) (10) ..... 37.3x70.8                            |
| DW01748 <sup>a,c,g,h</sup> | Windshield (Solar) (W/Third Visor Frit, Acoustic Interlayer, Rain Sensor) ..... 37.3x70.8                         |
| DW01747 <sup>a,b,g,h</sup> | Windshield (Solar) (W/Third Visor Frit) ..... 37.3x70.8   |
| DD10464-65                 | Door F/R-L (Solar) ..... 26.8x33.4  |
| DD11520-21                 | Door R/R-L (Solar) (Platinum Edition) ..... 26.3x27.8   |
| DD11518-19                 | Door R/R-L (Solar) ..... 26.3x27.8  |
| DR09299                    | Roof (Solar) (09) ..... 18.0x40.0   |
| DB11709                    | Back Window C (Heated)(Solar) (OE, Power) (10) ..... 14.9x15.2  |
| DB10767                    | Back Window C (Solar) (OE, Movable, Manual) ..... 15.0x15.2   |
| DB10672                    | Back Window C (Solar) (OE, Power, Movable) (09) .... 14.9x15.2  |
| DY90114 <sup>f</sup>       | Back Window (Slider)(Solar) (Aftermarket, 1 Panel Flush Fit, Manual) ..... 18.5x65.5                              |
| DY90110 <sup>f</sup>       | Back Window (Encap)(Slider)(Solar) (Black Frame, Aftermarket, Power, Bolt-In, 3 Panel Encapsulated) ... 18.5x65.5 |
| DY90109 <sup>f</sup>       | Back Window (Encap)(Slider)(Solar) (Black Frame, Aftermarket, Manual, Bolt-In, 3 Panel Encapsulated) . 18.5x65.5  |
| DB11827 <sup>b,f</sup>     | Back Window (Encap)(Slider)(Solar) (Assembly, Aftermarket, Power, 3 Piece, W/O Motor) (09) ..... 18.5x65.5        |
| DB11710 <sup>d</sup>       | Back Window (Encap)(Heated)(Solar) (Stationary, 4-Pin Connector) (10) ..... 17.0x64.0                             |
| DB11708 <sup>f</sup>       | Back Window (Encap)(Heated)(Slider)(Solar) (OE, 3 Piece Assembly, Power) (10) ..... 18.5x65.5                     |
| DB11577 <sup>c,f</sup>     | Back Window (Encap)(Slider)(Solar) (OE, Assembly, Power, 3 Piece) (09) ..... 18.5x65.5                            |
| DB11576 <sup>f</sup>       | Back Window (Encap)(Slider)(Solar) (OE, Assembly, 3 Piece, Manual) ..... 18.5x65.5                                |
| DB11523 <sup>e</sup>       | Back Window (Encap)(Heated)(Solar) (Stationary, 2-Pin Connector) (09) ..... 17.0x64.0                             |

| <b>Lobo</b>  | <b>(cont.)</b>   |
|--|------------------|
| <b>DB11522<sup>e</sup></b> Back Window (Encap)(Solar) (Stationary) ..... | <b>17.0x64.0</b> |
| <sup>a</sup> May Require Two Person Installation                         |                  |
| <sup>b</sup> Not On Production Vehicles                                  |                  |
| <sup>c</sup> On Production Vehicles                                      |                  |
| <sup>d</sup> Urethane,Dam,Primer - 1.5 Tubes                             |                  |
| <sup>e</sup> Foam Core Butyl Tape - Quantity 1.5                         |                  |
| <sup>f</sup> Foam Core Butyl Tape - Quantity 2                           |                  |
| <sup>g</sup> Urethane,Dam,Primer - 2.5 Tubes                             |                  |
| <sup>h</sup> Fast-Cure Urethane/Dam/Primer - Quantity 2.5                |                  |

**Lobo 4 Door Crew Cab (MEXICO Only)..... 2006-2008**

|   |                  |
|---|------------------|
| <b>DW01551<sup>a e f</sup></b> Windshield (Solar) (W/Third Visor Frit, Aftermarket)   | <b>37.2x70.7</b> |
| <b>DW01548<sup>a d e f</sup></b> Windshield (Solar) (W/Third Visor Frit) .....  | <b>37.2x70.7</b> |
| <b>DD10462-63</b> Door F/R-L (Solar) .....  | <b>26.4x27.1</b> |
| <b>DD10466-67</b> Door R/R-L (Solar) .....  | <b>26.4x27.7</b> |
| <b>DR09299</b> Roof (Solar) .....   | <b>18.0x40.0</b> |
| <b>DB10767</b> Back Window C (Solar) (OE, Movable, Manual) .....  | <b>15.0x15.2</b> |
| <b>DB10672</b> Back Window C (Solar) (OE, Power, Movable) .....   | <b>14.9x15.2</b> |
| <b>DY90114<sup>h</sup></b> Back Window (Slider)(Solar) (Aftermarket, 1 Panel Flush Fit, Manual) .....   | <b>18.5x65.5</b> |
| <b>DY90110<sup>h</sup></b> Back Window (Encap)(Slider)(Solar) (Black Frame, Aftermarket, Power, Bolt-In, 3 Panel Encapsulated) ....             | <b>18.5x65.5</b> |
| <b>DY90109<sup>h</sup></b> Back Window (Encap)(Slider)(Solar) (Black Frame, Aftermarket, Manual, Bolt-In, 3 Panel Encapsulated) ..              | <b>18.5x65.5</b> |
| <b>DB11133<sup>b c h</sup></b> Back Window (Encap)(Slider)(Solar) (OE, Manual & Power, W/O Center Sliding Glass, W/O Motor, Sub-Assembly) ..... | <b>18.5x65.5</b> |
| <b>DB10951<sup>h</sup></b> Back Window (Encap)(Slider)(Solar) (OE, Assembly, Power, 3 Piece) .....  | <b>18.5x65.5</b> |
| <b>DB10474<sup>h</sup></b> Back Window (Encap)(Slider)(Solar) (OE, Assembly, 3 Piece, Manual) .....   | <b>18.5x65.5</b> |
| <b>DB10473<sup>g</sup></b> Back Window (Encap)(Heated)(Solar) (Stationary) ....   | <b>17.0x64.0</b> |
| <b>DB10472<sup>g</sup></b> Back Window (Encap)(Solar) (Stationary) .....  | <b>17.0x64.0</b> |
| <sup>a</sup> May Require Two Person Installation  |                  |
| <sup>b</sup> When Replacing a Power Slider, Plastic Insert # 4L3Z 15422B68 AA in the Lower Glass Run Channel Must Be Removed                    |                  |
| <sup>c</sup> Does Not Come With Center Slider   |                  |
| <sup>d</sup> On Production Vehicles in Mexico Only  |                  |
| <sup>e</sup> Urethane,Dam,Primer - 2 Tubes  |                  |
| <sup>f</sup> Fast-Cure Urethane/Dam/Primer - Quantity 2   |                  |
| <sup>g</sup> Foam Core Butyl Tape - Quantity 1.5  |                  |
| <sup>h</sup> Foam Core Butyl Tape - Quantity 2  |                  |

**Mondeo 4 Door Sedan (MEXICO Only)..... 2006-2007**

|   |                  |
|---|------------------|
| <b>DW01477<sup>a b</sup></b> Windshield (Mexico Only) .....         | <b>35.0x59.0</b> |
| <b>DD10112-13</b> Door F/R-L (Mexico Only) .....                    | <b>19.0x37.0</b> |
| <b>DD10115</b> Door R/L (Mexico Only) .....                         | <b>19.0x25.0</b> |
| <b>DD10114</b> Door R/R (1 Holes) (Mexico Only) .....               | <b>19.0x25.0</b> |
| <b>DV10122-23</b> Vent R/R-L (Mexico Only) .....                    | <b>7.5x11.0</b>  |
| <b>DB10116<sup>c</sup></b> Back Window (Heated) (Mexico Only) ..... | <b>29.0x49.5</b> |
| <sup>a</sup> Urethane,Dam,Primer - 2 Tubes                          |                  |
| <sup>b</sup> Fast-Cure Urethane/Dam/Primer - Quantity 2             |                  |
| <sup>c</sup> Urethane,Dam,Primer - 1.5 Tubes                        |                  |

**Mustang 2 Door Convertible..... 2006-2011**

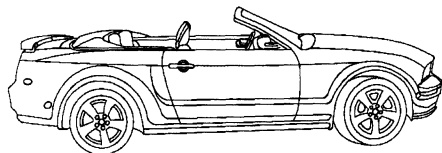

|  |                  |
|--|------------------|
| <b>DW01609<sup>a c d</sup></b> Windshield (Solar) (Aftermarket) .....  | <b>32.4x61.1</b> |
| <b>DW01570<sup>b c d</sup></b> Windshield (Solar) (Mustang Logo) ..... | <b>32.4x61.1</b> |
| <b>DD10701-02</b> Door F/R-L (2 Holes)(Solar) .....                    | <b>21.7x42.8</b> |

| <b>Mustang</b>   | <b>(cont.)</b>   |
|--|------------------|
| <b>DQ11681-82</b> Quarter R-L (Solar) (10-11) .....                        | <b>16.3x16.5</b> |
| <b>DQ11031-32</b> Quarter R-L (Solar) (06-09) .....                        | <b>15.9x16.5</b> |
| <b>DB11008</b> Back Window (Heated)(Solar) (Glass Only, Aftermarket) ..... | <b>16.2x49.6</b> |
| <sup>a</sup> Not On Production Vehicles                                    |                  |
| <sup>b</sup> On Production Vehicles  |                  |
| <sup>c</sup> Urethane,Dam,Primer - 2 Tubes                                 |                  |
| <sup>d</sup> Fast-Cure Urethane/Dam/Primer - Quantity 2                    |                  |

**Mustang 2 Door Coupe..... 2006-2011**

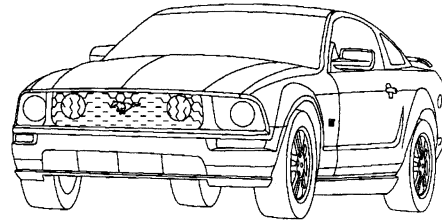

|  |                  |
|--|------------------|
| <b>DW01609<sup>a c d</sup></b> Windshield (Solar) (Aftermarket) .....                          | <b>32.4x61.1</b> |
| <b>DW01570<sup>b c d</sup></b> Windshield (Solar) (Mustang Logo) .....                         | <b>32.4x61.1</b> |
| <b>DD10696-97</b> Door F/R-L (2 Holes)(Solar) .....  | <b>21.7x42.7</b> |
| <b>DQ11721-22<sup>e</sup></b> Quarter R-L (Solar) (10-11) .....                                | <b>8.5x19.0</b>  |
| <b>DQ10698-99<sup>e</sup></b> Quarter R-L (Solar) (06-09) .....                                | <b>9.1x19.4</b>  |
| <b>DB11849<sup>c</sup></b> Back Window (Heated)(Solar) (High Amp) (11) .....                   | <b>36.9x51.8</b> |
| <b>DB11737<sup>c</sup></b> Back Window (Heated)(Solar) (High Amp) (From 06/22/2009) (10) ..... | <b>36.9x51.8</b> |
| <b>DB10700<sup>c</sup></b> Back Window (Heated)(Solar) (To 06/22/2009) (06-10) .....           | <b>36.9x51.8</b> |
| <sup>a</sup> Not On Production Vehicles  |                  |
| <sup>b</sup> On Production Vehicles  |                  |
| <sup>c</sup> Urethane,Dam,Primer - 2 Tubes   |                  |
| <sup>d</sup> Fast-Cure Urethane/Dam/Primer - Quantity 2  |                  |
| <sup>e</sup> Urethane,Dam,Primer - 1 Tube  |                  |

**Ranger Pickup 2 Door Standard Cab..... 2006-2011**

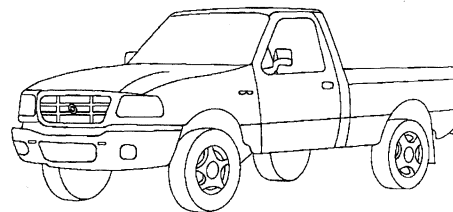

|   |                  |
|---|------------------|
| <b>DW01620<sup>b e f</sup></b> Windshield (Solar) ("Ranger" in 3rd Visor Frit) .....                              | <b>28.4x56.4</b> |
| <b>DW01357<sup>a e f</sup></b> Windshield (Solar) (Ford Logo Lwr Paint Band) .....                                | <b>28.4x56.4</b> |
| <b>DW01335<sup>a e f</sup></b> Windshield (Solar) (Ford Oval In Shade Band) .....                                 | <b>28.4x56.4</b> |
| <b>DW01317<sup>c d e f</sup></b> Windshield (Solar) .....   | <b>28.4x56.4</b> |
| <b>DD10318-19</b> Door F/R-L (2 Holes)(Solar) .....   | <b>22.0x30.0</b> |
| <b>DB10801</b> Back Window C (Solar) (OE, Movable) .....  | <b>14.1x14.8</b> |
| <b>DY90071<sup>g</sup></b> Back Window (Encap)(Slider)(Solar) (Urethane, Aftermarket, 3 Panel Encapsulated) ..... | <b>17.8x51.8</b> |
| <b>DY90040<sup>g</sup></b> Back Window (Encap)(Slider) (Urethane, Aftermarket, Power, 3 Panel Encapsulated) ..... | <b>17.8x51.8</b> |
| <b>DY90039<sup>g</sup></b> Back Window (Encap)(Slider) (Urethane, Aftermarket, 4 Panel Encapsulated) .....        | <b>17.8x51.8</b> |
| <b>DB10883<sup>h</sup></b> Back Window (Encap)(Slider)(Solar) (OE, Assembly) .....                                | <b>17.8x51.8</b> |
| <b>DB10882<sup>h</sup></b> Back Window (Encap)(Solar) (Stationary) .....  | <b>15.0x49.0</b> |
| <sup>a</sup> Not On Production Vehicles   |                  |
| <sup>b</sup> On Production Vehicles   |                  |
| <sup>c</sup> Not On Production Vehicles 2006-2010   |                  |
| <sup>d</sup> On Production Vehicles 1998-2005   |                  |

**Ranger Pickup (cont.)**

- <sup>e</sup> Urethane,Dam,Primer - 2 Tubes
- <sup>f</sup> Fast-Cure Urethane/Dam/Primer - Quantity 2
- <sup>g</sup> Urethane,Dam,Primer - 1.5 Tubes
- <sup>h</sup> Foam Core Butyl Tape - Quantity 1.5

**Ranger Pickup 2 Door Super Cab ..... 2006-2011**

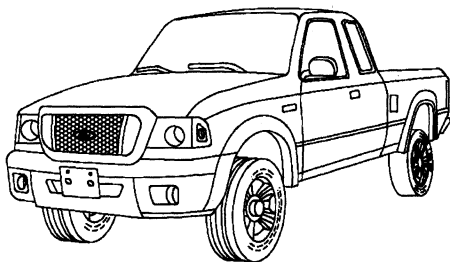

|                            |   |           |
|----------------------------|---|-----------|
| DW01620 <sup>b e f</sup>   | Windshield (Solar) ("Ranger" in 3rd Visor Frit)   | 28.4x56.4 |
| DW01357 <sup>a e f</sup>   | Windshield (Solar) (Ford Logo Lwr Paint Band)   | 28.4x56.4 |
| DW01335 <sup>a e f</sup>   | Windshield (Solar) (Ford Oval In Shade Band)  | 28.4x56.4 |
| DW01317 <sup>c d e f</sup> | Windshield (Solar)  | 28.4x56.4 |
| DD10318-19                 | Door F/R-L (2 Holes)(Solar)   | 22.0x30.0 |
| DQ09411-12 <sup>1</sup>    | Quarter R-L (Encap)(Solar) (One-Sided Rim Encapsulation, Rear Access Door)                    | 15.0x18.5 |
| DQ09345-46 <sup>1</sup>    | Quarter R-L (Solar) (Stationary)  | 14.8x16.9 |
| DB10801                    | Back Window C (Solar) (OE, Movable)   | 14.1x14.8 |
| DY90098 <sup>g</sup>       | Back Window (Encap)(Slider)(Solar) (Urethane, Aftermarket, Power, Flat, 3 Panel Encapsulated) | 17.8x51.8 |
| DY90071 <sup>g</sup>       | Back Window (Encap)(Slider)(Solar) (Urethane, Aftermarket, 3 Panel Encapsulated)              | 17.8x51.8 |
| DY90040 <sup>g</sup>       | Back Window (Encap)(Slider) (Urethane, Aftermarket, Power, 3 Panel Encapsulated)              | 17.8x51.8 |
| DY90039 <sup>g</sup>       | Back Window (Encap)(Slider) (Urethane, Aftermarket, 4 Panel Encapsulated)                     | 17.8x51.8 |
| DB10883 <sup>h</sup>       | Back Window (Encap)(Slider)(Solar) (OE, Assembly)   | 17.8x51.8 |
| DB10882 <sup>h</sup>       | Back Window (Encap)(Solar) (Stationary)   | 15.0x49.0 |

<sup>a</sup> Not On Production Vehicles  
<sup>b</sup> On Production Vehicles  
<sup>c</sup> Not On Production Vehicles 2006-2010  
<sup>d</sup> On Production Vehicles 1998-2005  
<sup>e</sup> Urethane,Dam,Primer - 2 Tubes  
<sup>f</sup> Fast-Cure Urethane/Dam/Primer - Quantity 2  
<sup>g</sup> Urethane,Dam,Primer - 1.5 Tubes  
<sup>h</sup> Foam Core Butyl Tape - Quantity 1.5  
<sup>i</sup> Foam Core Butyl Tape - Quantity 1

**Ranger Pickup 4 Door Crew Cab(MEXICO Only) 2006-2010**

|                          |  |           |
|--------------------------|--|-----------|
| DW01317 <sup>a b c</sup> | Windshield (Solar)                                   | 28.4x56.4 |
| DD10318-19               | Door F/R-L (2 Holes)(Solar)                          | 22.0x30.0 |
| DD11067-68               | Door R/R-L (2 Holes)(Solar) (Mexico Only)            | 21.3x23.5 |
| DB11070 <sup>d</sup>     | Back Window (Encap)(Slider)(Solar) (OE, Mexico Only) | 16.0x49.5 |
| DB11069 <sup>d</sup>     | Back Window (Solar) (Stationary, OE, Mexico Only)    | 16.0x49.5 |
| DB08400 <sup>d</sup>     | Back Window (Slider)(Solar) (OE)                     | 15.0x48.5 |
| DB07640 <sup>d</sup>     | Back Window (W/Band, Fixed Glass, Flat)              | 15.0x48.5 |

<sup>a</sup> On Production Vehicles  
<sup>b</sup> Urethane,Dam,Primer - 2 Tubes  
<sup>c</sup> Fast-Cure Urethane/Dam/Primer - Quantity 2  
<sup>d</sup> Urethane,Dam,Primer - 1.5 Tubes

**Taurus 4 Door Sedan..... 2010-2011**

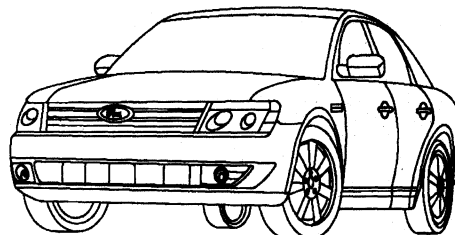

|                          |   |           |
|--------------------------|---|-----------|
| DW01873 <sup>a c d</sup> | Windshield (Solar) (W/Third Visor Frit, Aftermarket, Rain Sensor)                           | 35.7x62.4 |
| DW01872 <sup>a c d</sup> | Windshield (Solar) (W/Third Visor Frit, Aftermarket)  | 35.7x62.4 |
| DW01787 <sup>b c d</sup> | Windshield (Solar) (High Beam Sensor, W/Third Visor Frit, Acoustic Interlayer, Rain Sensor) | 35.7x62.4 |
| DW01786 <sup>b c d</sup> | Windshield (Solar) (W/Third Visor Frit, Acoustic Interlayer)                                | 35.7x62.4 |
| DD11651-52               | Door F/R-L (Solar) (Laminated, Acoustic Interlayer)   | 23.8x34.5 |
| DD11649-50               | Door F/R-L (2 Holes)(Solar)   | 23.8x34.5 |
| DD11653-54               | Door R/R-L (Solar)  | 18.5x24.6 |
| DR11723                  | Roof (Solar)  | 18.8x32.3 |
| DV11655-56               | Vent R/R-L (Solar)  | 11.5x14.0 |
| DB11657 <sup>c</sup>     | Back Window (Heated)(Solar)   | 35.4x53.5 |

<sup>a</sup> Not On Production Vehicles  
<sup>b</sup> On Production Vehicles  
<sup>c</sup> Urethane,Dam,Primer - 2 Tubes  
<sup>d</sup> Fast-Cure Urethane/Dam/Primer - Quantity 2

**Taurus 4 Door Sedan..... 2008-2009**

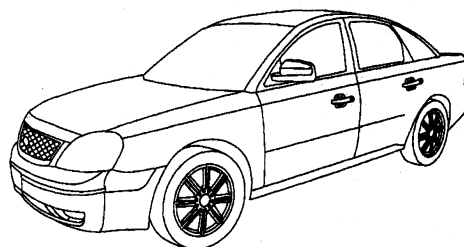

|                         |  |           |
|-------------------------|--|-----------|
| DW01690 <sup>a b</sup>  | Windshield (Solar) (Electrochromic Mirror, W/Third Visor Frit) | 38.9x63.7 |
| DD10683-84              | Door F/R-L (Solar)   | 22.6x34.3 |
| DD10685-86              | Door R/R-L (Solar)   | 22.2x30.3 |
| DR10690                 | Roof (Solar)   | 17.8x33.5 |
| DQ10687-88 <sup>c</sup> | Quarter R-L (Encap)(Solar)                                     | 14.0x24.3 |
| DB11345 <sup>a</sup>    | Back Window (Ant)(Heated)(Solar)                               | 34.9x55.4 |

<sup>a</sup> Urethane,Dam,Primer - 2 Tubes  
<sup>b</sup> Fast-Cure Urethane/Dam/Primer - Quantity 2  
<sup>c</sup> Urethane,Dam,Primer - 1 Tube

**Taurus 4 Door Sedan..... 2006-2007**

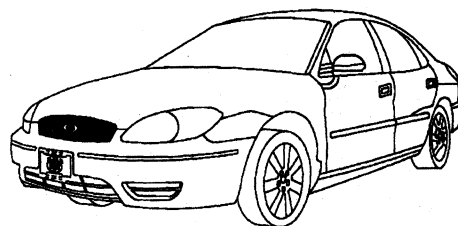

|                        |                             |           |
|------------------------|-----------------------------|-----------|
| DW01528 <sup>a b</sup> | Windshield (Solar)          | 40.0x63.0 |
| DD08853-54             | Door F/R-L (2 Holes)(Solar) | 25.0x35.5 |
| DD08855-56             | Door R/R-L (2 Holes)(Solar) | 23.3x30.3 |

| <b>Taurus</b>   |  | <b>(cont.)</b>   |
|---|--|------------------|
| <b>DR09308</b>  | Roof .....                               | <b>17.3x31.8</b> |
| <b>DQ08857-58<sup>c</sup></b>                           | Quarter R-L (Solar) .....                | <b>12.5x13.2</b> |
| <b>DB10205<sup>a</sup></b>                              | Back Window (Encap)(Heated)(Solar) ..... | <b>31.3x55.0</b> |
| <sup>a</sup> Urethane,Dam,Primer - 2 Tubes              |  |                  |
| <sup>b</sup> Fast-Cure Urethane/Dam/Primer - Quantity 2 |  |                  |
| <sup>c</sup> Foam Core Butyl Tape - Quantity 1          |  |                  |

**Taurus X 4 Door Utility** ..... **2008-2009**

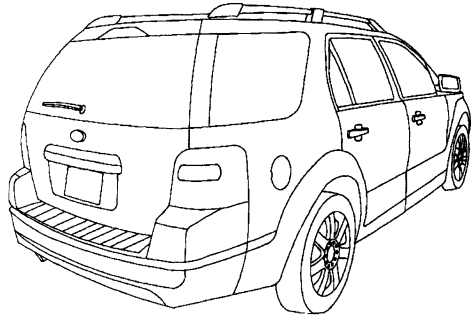

|   |  |                  |
|---|--|------------------|
| <b>DW01691<sup>a b</sup></b>                            | Windshield (Solar) (W/Third Visor Frit) .....      | <b>38.5x62.6</b> |
| <b>DD10673-74</b>                                       | Door F/R-L (Solar) .....                           | <b>23.1x36.8</b> |
| <b>DD10675-76</b>                                       | Door R/R-L (Solar) .....                           | <b>22.4x28.3</b> |
| <b>DR10682</b>  | Roof F (Solar) (Assembly, Movable) .....           | <b>17.8x33.5</b> |
| <b>DQ10679-80<sup>c</sup></b>                           | Quarter R-L (Solar) .....                          | <b>18.7x39.1</b> |
| <b>DV10677-78</b>                                       | Vent R/R-L (Solar) .....                           | <b>9.4x17.7</b>  |
| <b>DB10681<sup>c</sup></b>                              | Back Window (Heated)(1 Holes)(Solar) (W/Wiper) ... | <b>20.9x54.9</b> |
| <sup>a</sup> Urethane,Dam,Primer - 2 Tubes              |  |                  |
| <sup>b</sup> Fast-Cure Urethane/Dam/Primer - Quantity 2 |  |                  |
| <sup>c</sup> Urethane,Dam,Primer - 1.5 Tubes            |  |                  |

**Transit CONNECT Mini Van** ..... **2010-2011**

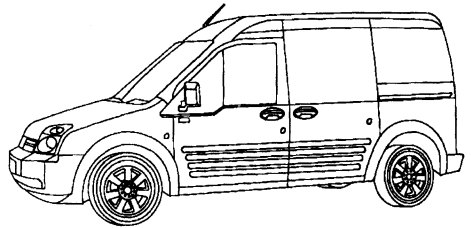

|   |  |                  |
|---|--|------------------|
| <b>DW01815<sup>a b</sup></b>                            | Windshield (Solar) (W/Third Visor Frit) .....          | <b>38.0x60.0</b> |
| <b>DD11726-27</b>                                       | Door F/R-L (Solar) .....                               | <b>21.0x24.0</b> |
| <b>DD11728-29<sup>c</sup></b>                           | Door R/R-L (Solar) (Stationary, Sliding Cargo Door) .. | <b>23.0x33.0</b> |
| <b>DV11724-25</b>                                       | Vent F/R-L (Solar) .....                               | <b>13.0x21.0</b> |
| <b>DB11732-33<sup>d</sup></b>                           | Back Window R-L (Heated)(Solar) (W/Wiper) .....        | <b>22.7x23.7</b> |
| <b>DB11730-31<sup>d</sup></b>                           | Back Window R-L (Solar) (W/Wiper) .....                | <b>22.7x23.7</b> |
| <sup>a</sup> Urethane,Dam,Primer - 2 Tubes              |  |                  |
| <sup>b</sup> Fast-Cure Urethane/Dam/Primer - Quantity 2 |  |                  |
| <sup>c</sup> Urethane,Dam,Primer - 1.5 Tubes            |  |                  |
| <sup>d</sup> Urethane,Dam,Primer - 1 Tube               |  |                  |

**Transit Van (MEXICO ONLY)** ..... **2007-2010**

|                               |  |  |
|-------------------------------|--|--|
| <b>DW01758<sup>a b</sup></b>  | Windshield (Solar) (W/Third Visor Frit, Mexico Only) |  |
| <b>DD11534-35</b>             | Door F/R-L (Solar) (Mexico Only) .....               |  |
| <b>DD11536-37</b>             | Door R/R-L (Solar) (Mexico Only, Sliding) .....      |  |
| <b>DQ11540-41</b>             | Quarter R-L (Solar) (Mexico Only, Movable) .....     |  |
| <b>DQ11538-39<sup>c</sup></b> | Quarter R-L (Solar) (Stationary, Mexico Only) .....  |  |
| <b>DV11532-33<sup>c</sup></b> | Vent F/R-L (Encap)(Solar) (Mexico Only) .....        |  |

| <b>Transit</b>  |   | <b>(cont.)</b> |
|---|---|----------------|
| <b>DB11542-43<sup>c</sup></b>                           | Back Window R-L (Heated)(Solar) (Mexico Only) ..... |                |
| <sup>a</sup> Urethane,Dam,Primer - 2 Tubes              |   |                |
| <sup>b</sup> Fast-Cure Urethane/Dam/Primer - Quantity 2 |   |                |
| <sup>c</sup> Urethane,Dam,Primer - 1.5 Tubes            |   |                |

**Sprinter Cutaway Van** ..... **2006**

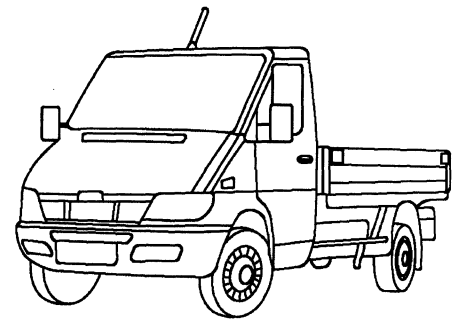

|  |  |                  |
|--|--|------------------|
| <b>DW01578<sup>a b</sup></b>   | Windshield (Heated)(Solar) (Heated Wiper Park Area, Rain Sensor) ..... | <b>33.0x66.0</b> |
| <b>DW01577<sup>a b</sup></b>   | Windshield (Solar) .....   | <b>33.0x66.0</b> |
| <b>DD10197-98</b>  | Door F/R-L (Solar) .....   | <b>20.0x25.0</b> |
| <b>DV10195-96</b>  | Vent F/R-L (Solar) .....   | <b>12.5x22.9</b> |
| <b>DB10733</b>   | Back Window (Solar) (Gasket Set) .....                                 |                  |
| <sup>a</sup> May Require Two Person Installation                       |  |                  |
| <sup>b</sup> High Modulus Non-Conductive Urethane,Dam,Primer - 2 Tubes |  |                  |

**Sprinter 144" WB Van** ..... **2007-2010**

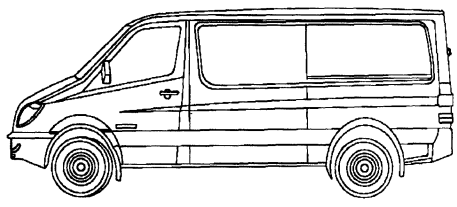

|                                 |  |                  |
|---------------------------------|--|------------------|
| <b>DW01721<sup>a i</sup></b>    | Windshield (Heated)(Solar) (W/Third Visor Frit, Rain/Light Sensor, Fully Heated) ..... | <b>42.0x70.0</b> |
| <b>DW01720<sup>a i</sup></b>    | Windshield (Solar) (W/Third Visor Frit, Rain/Light Sensor) .....                       | <b>42.0x70.0</b> |
| <b>DW01719<sup>a i</sup></b>    | Windshield (Solar) (W/Third Visor Frit) .....  | <b>42.0x70.0</b> |
| <b>DD11394-95</b>               | Door F/R-L (Solar) .....   |                  |
| <b>DD11857<sup>b d</sup></b>    | Door R/R (Encap)(Solar) (Sliding Cargo Door, Aftermarket, Movable) .....               | <b>30.3x56.0</b> |
| <b>DD11396-97<sup>c h</sup></b> | Door R/R-L (Solar) (Sliding Cargo Door) .....  | <b>30.3x56.0</b> |
| <b>DD11858<sup>b e</sup></b>    | Side L (Encap)(Solar) (Body Side, Aftermarket, Movable) .....                          | <b>30.3x56.0</b> |
| <b>DD11398-99<sup>c</sup></b>   | Side R-L (Solar) (Body Side) .....   | <b>30.3x55.3</b> |
| <b>DQ11406-07</b>               | Quarter F/R-L (Solar) (W/O Sliding Cargo Door, Stationary) .....                       |                  |
| <b>DQ11404-05</b>               | Quarter F/R-L (Solar) (Stationary, W/Sliding Cargo Door) .....                         |                  |
| <b>DQ11410-11</b>               | Quarter R/R-L (Solar) (W/O Sliding Cargo Door, Movable) .....                          |                  |
| <b>DQ11408-09</b>               | Quarter R/R-L (Solar) (Movable, W/Sliding Cargo Door) .....                            |                  |
| <b>DQ11860<sup>b g</sup></b>    | Quarter L (Encap)(Solar) (W/O Sliding Cargo Door, Aftermarket, Movable) .....          | <b>30.1x64.3</b> |
| <b>DQ11859<sup>b f</sup></b>    | Quarter R (Encap)(Solar) (Aftermarket, Movable, W/ Sliding Cargo Door) .....           | <b>27.6x64.2</b> |

**Sprinter**

(cont.)

|   |                  |
|---|------------------|
| <b>DQ11402-03<sup>c</sup></b> Quarter R-L (Solar) (W/O Sliding Cargo Door, One-Piece) ..... | <b>30.3x64.5</b> |
| <b>DQ11400-01<sup>c</sup></b> Quarter R-L (Solar) (One-Piece, W/Sliding Cargo Door) .....   | <b>27.8x64.3</b> |
| <b>DV11392-93</b> Vent F/R-L (Solar) .....  | <b>10.0x25.3</b> |
| <b>DB11420-21<sup>l</sup></b> Back Window R-L (Heated)(Solar) .....                         | <b>31.5x33.0</b> |
| <b>DB11418-19<sup>l</sup></b> Back Window R-L (Solar) .....                                 | <b>31.5x33.0</b> |

<sup>a</sup> May Require Two Person Installation  
<sup>b</sup> Not On Production Vehicles  
<sup>c</sup> On Production Vehicles  
<sup>d</sup> Movable Aftermarket  
<sup>e</sup> Movable Aftermarket Replacement for DD11399  
<sup>f</sup> Movable Aftermarket Replacement for DD11400  
<sup>g</sup> Movable Aftermarket Replacement for DD11403  
<sup>h</sup> High Modulus Non-Conductive Urethane,Dam,Primer - 2 Tubes  
<sup>i</sup> High Modulus Non-Conductive Urethane,Dam,Primer - 2.5 Tubes  
<sup>j</sup> High Modulus Non-Conductive Urethane,Dam,Primer - 1.5 Tubes

**Sprinter 170" WB Van ..... 2007-2010**

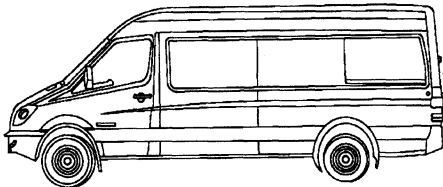

|   |                  |
|---|------------------|
| <b>DW01721<sup>a,k</sup></b> Windshield (Heated)(Solar) (W/Third Visor Frit, Rain/Light Sensor, Fully Heated) ..... | <b>42.0x70.0</b> |
| <b>DW01720<sup>a,k</sup></b> Windshield (Solar) (W/Third Visor Frit, Rain/Light Sensor) .....                       | <b>42.0x70.0</b> |
| <b>DW01719<sup>a,k</sup></b> Windshield (Solar) (W/Third Visor Frit) .....  | <b>42.0x70.0</b> |
| <b>DD11394-95</b> Door F/R-L (Solar) .....  |                  |
| <b>DD11857<sup>b,d</sup></b> Door R/R (Encap)(Solar) (Sliding Cargo Door, Aftermarket, Movable) .....               | <b>30.3x56.0</b> |
| <b>DD11396-97<sup>f</sup></b> Door R/R-L (Solar) (Sliding Cargo Door) .....   | <b>30.3x56.0</b> |
| <b>DD11858<sup>b,e</sup></b> Side L (Encap)(Solar) (Body Side, Aftermarket, Movable) .....                          | <b>30.3x56.0</b> |
| <b>DD11398-99<sup>c</sup></b> Side R-L (Solar) (Body Side) .....  | <b>30.3x55.3</b> |
| <b>DQ11862<sup>b,g</sup></b> Quarter F/L (Encap)(Solar) (W/O Sliding Cargo Door, Aftermarket, Movable) .....        | <b>30.3x55.8</b> |
| <b>DQ11861<sup>b,f</sup></b> Quarter F/R (Encap)(Solar) (Aftermarket, Movable, W/Sliding Cargo Door) .....          | <b>30.3x55.3</b> |
| <b>DQ11414-15<sup>c</sup></b> Quarter F/R-L (Solar) (W/O Sliding Cargo Door) .....                                  | <b>30.3x56.0</b> |
| <b>DQ11412-13<sup>c</sup></b> Quarter F/R-L (Solar) (W/Sliding Cargo Door) .....                                    | <b>27.8x55.8</b> |
| <b>DQ11864<sup>b,i</sup></b> Quarter R/L (Encap)(Solar) (Aftermarket, Movable) ...                                  | <b>29.6x49.0</b> |
| <b>DQ11863<sup>b,h</sup></b> Quarter R/R (Encap)(Solar) (Aftermarket, Movable) ...                                  | <b>29.6x52.8</b> |
| <b>DQ11416-17<sup>c</sup></b> Quarter R/R-L (Solar) .....   | <b>30.3x49.5</b> |
| <b>DV11392-93</b> Vent F/R-L (Solar) .....  | <b>10.0x25.3</b> |
| <b>DB11420-21<sup>l</sup></b> Back Window R-L (Heated)(Solar) .....   | <b>31.5x33.0</b> |
| <b>DB11418-19<sup>l</sup></b> Back Window R-L (Solar) .....   | <b>31.5x33.0</b> |

<sup>a</sup> May Require Two Person Installation  
<sup>b</sup> Not On Production Vehicles  
<sup>c</sup> On Production Vehicles  
<sup>d</sup> Movable Aftermarket  
<sup>e</sup> Movable Aftermarket Replacement for DD11399  
<sup>f</sup> Movable Aftermarket Replacement for DD11412  
<sup>g</sup> Movable Aftermarket Replacement for DD11415  
<sup>h</sup> Movable Aftermarket Replacement for DD11416  
<sup>i</sup> Movable Aftermarket Replacement for DD11417  
<sup>j</sup> High Modulus Non-Conductive Urethane,Dam,Primer - 2 Tubes  
<sup>k</sup> High Modulus Non-Conductive Urethane,Dam,Primer - 2.5 Tubes  
<sup>l</sup> High Modulus Non-Conductive Urethane,Dam,Primer - 1.5 Tubes

**Sprinter 118WB Van ..... 2006**

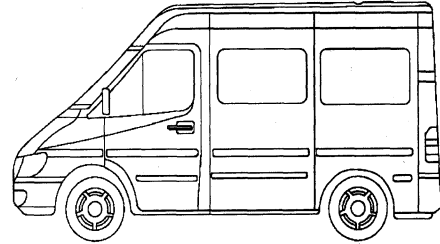

|   |                  |
|---|------------------|
| <b>DW01573<sup>a,b</sup></b> Windshield (Heated)(Solar) (Heated Wiper Park Area, Rain Sensor) ..... | <b>34.0x66.0</b> |
| <b>DW01488<sup>a,b</sup></b> Windshield (Solar) .....   | <b>34.0x66.0</b> |
| <b>DD10197-98</b> Door F/R-L (Solar) .....  | <b>20.0x25.0</b> |
| <b>DD10741</b> Door M/L (Solar) (Movable, Two-Piece) .....  |                  |
| <b>DD10739</b> Door M/L (Solar) (Stationary, Two-Piece) .....                                       |                  |
| <b>DD10737</b> Door M/L (Solar) (Assembly, Two-Piece) .....   |                  |
| <b>DD10740</b> Door M/R (Solar) (Movable, Two-Piece) .....  |                  |
| <b>DD10738</b> Door M/R (Solar) (Stationary, Two-Piece) .....                                       |                  |
| <b>DD10736</b> Door M/R (Solar) (Assembly, Two-Piece) .....   |                  |
| <b>DD10199</b> Door M/R-L (Solar) (Stationary, One-Piece) .....                                     | <b>24.2x42.0</b> |
| <b>DD10744</b> Side L (Solar) (Stationary, Two-Piece) .....   |                  |
| <b>DD10743</b> Side L (Solar) (Assembly, Two-Piece) .....   |                  |
| <b>DD10742</b> Side L (Solar) (Stationary, One-Piece) .....   | <b>24.2x40.4</b> |
| <b>DD10741</b> Side L (Solar) (Movable, Two-Piece) .....  |                  |
| <b>DD10742</b> Quarter R-L (Solar) (Stationary, One-Piece) .....                                    | <b>24.2x40.4</b> |
| <b>DV10195-96</b> Vent F/R-L (Solar) .....  | <b>12.5x22.9</b> |
| <b>DB10758-59</b> Back Window R-L (Solar) (Paint Band) .....  |                  |
| <b>DB10203-04</b> Back Window R-L (Heated)(Solar) .....   |                  |

<sup>a</sup> May Require Two Person Installation  
<sup>b</sup> High Modulus Non-Conductive Urethane,Dam,Primer - 2 Tubes

**Sprinter 140WB Van ..... 2006**

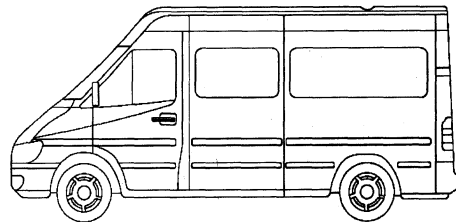

|   |                  |
|---|------------------|
| <b>DW01573<sup>a,b</sup></b> Windshield (Heated)(Solar) (Heated Wiper Park Area, Rain Sensor) ..... | <b>34.0x66.0</b> |
| <b>DW01488<sup>a,b</sup></b> Windshield (Solar) .....   | <b>34.0x66.0</b> |
| <b>DD10197-98</b> Door F/R-L (Solar) .....  | <b>20.0x25.0</b> |
| <b>DD10741</b> Door M/L (Solar) (Movable, Two-Piece) .....  |                  |
| <b>DD10739</b> Door M/L (Solar) (Stationary, Two-Piece) .....                                       |                  |
| <b>DD10737</b> Door M/L (Solar) (Assembly, Two-Piece) .....   |                  |
| <b>DD10740</b> Door M/R (Solar) (Movable, Two-Piece) .....  |                  |
| <b>DD10738</b> Door M/R (Solar) (Stationary, Two-Piece) .....                                       |                  |
| <b>DD10736</b> Door M/R (Solar) (Assembly, Two-Piece) .....   |                  |
| <b>DD10199</b> Door M/R-L (Solar) (Stationary, One-Piece) .....                                     | <b>24.2x42.0</b> |
| <b>DD10744</b> Side L (Solar) (Stationary, Two-Piece) .....   |                  |
| <b>DD10743</b> Side L (Solar) (Assembly, Two-Piece) .....   |                  |
| <b>DD10742</b> Side L (Solar) (Stationary, One-Piece) .....   | <b>24.2x40.4</b> |
| <b>DD10741</b> Side L (Solar) (Movable, Two-Piece) .....  |                  |
| <b>DQ10201</b> Quarter R-L (Solar) .....  | <b>24.5x71.0</b> |
| <b>DV10195-96</b> Vent F/R-L (Solar) .....  | <b>12.5x22.9</b> |
| <b>DB10758-59</b> Back Window R-L (Solar) (Paint Band) .....  |                  |
| <b>DB10203-04</b> Back Window R-L (Heated)(Solar) .....   |                  |

<sup>a</sup> May Require Two Person Installation  
<sup>b</sup> High Modulus Non-Conductive Urethane,Dam,Primer - 2 Tubes

**Sprinter 158WB Van..... 2006**

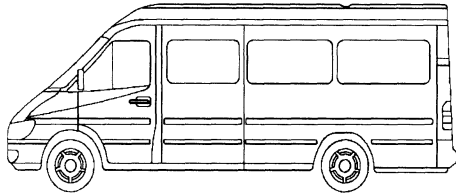

|                              |  |                  |
|------------------------------|--|------------------|
| <b>DW01573<sup>a,b</sup></b> | Windshield (Heated)(Solar) (Heated Wiper Park Area, Rain Sensor) ..... | <b>34.0x66.0</b> |
| <b>DW01488<sup>a,b</sup></b> | Windshield (Solar) .....   | <b>34.0x66.0</b> |
| <b>DD10197-98</b>            | Door F/R-L (Solar) .....   | <b>20.0x25.0</b> |
| <b>DD10741</b>               | Door M/L (Solar) (Movable, Two-Piece) .....                            |                  |
| <b>DD10739</b>               | Door M/L (Solar) (Stationary, Two-Piece) .....                         |                  |
| <b>DD10737</b>               | Door M/L (Solar) (Assembly, Two-Piece) .....                           |                  |
| <b>DD10740</b>               | Door M/R (Solar) (Movable, Two-Piece) .....                            |                  |
| <b>DD10738</b>               | Door M/R (Solar) (Stationary, Two-Piece) .....                         |                  |
| <b>DD10736</b>               | Door M/R (Solar) (Assembly, Two-Piece) .....                           |                  |
| <b>DD10199</b>               | Door M/R-L (Solar) (Stationary, One-Piece) .....                       | <b>24.2x42.0</b> |
| <b>DD10744</b>               | Side L (Solar) (Stationary, Two-Piece) .....                           |                  |
| <b>DD10743</b>               | Side L (Solar) (Assembly, Two-Piece) .....                             |                  |
| <b>DD10742</b>               | Side L (Solar) (Stationary, One-Piece) .....                           | <b>24.2x40.4</b> |
| <b>DD10741</b>               | Side L (Solar) (Movable, Two-Piece) .....                              |                  |
| <b>DQ10200</b>               | Quarter F-R/R-L (Solar) .....  | <b>24.5x52.0</b> |
| <b>DV10195-96</b>            | Vent F/R-L (Solar) .....   | <b>12.5x22.9</b> |
| <b>DB10758-59</b>            | Back Window R-L (Solar) (Paint Band) .....                             |                  |
| <b>DB10203-04</b>            | Back Window R-L (Heated)(Solar) .....                                  |                  |

<sup>a</sup> May Require Two Person Installation  
<sup>b</sup> High Modulus Non-Conductive Urethane,Dam,Primer - 2 Tubes

**Canyon 2 Door Extended Cab..... 2006-2011**

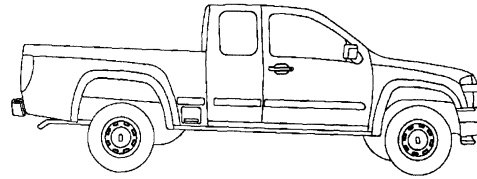

|                               |   |                  |
|-------------------------------|---|------------------|
| <b>DW01533<sup>a,b</sup></b>  | Windshield .....  | <b>32.0x57.4</b> |
| <b>DD10498-99</b>             | Door F/R-L .....  | <b>21.0x34.0</b> |
| <b>DQ10503-04<sup>d</sup></b> | Quarter R-L (Solar) .....   | <b>15.3x18.8</b> |
| <b>DY90108<sup>c</sup></b>    | Back Window (Encap)(Slider)(Solar) (Black Frame, Aftermarket, Power, 3 Panel Encapsulated) .....  | <b>13.7x54.0</b> |
| <b>DY90107<sup>c</sup></b>    | Back Window (Encap)(Slider)(Solar) (Black Frame, Aftermarket, Manual, 3 Panel Encapsulated) ..... | <b>13.7x54.0</b> |
| <b>DB10507<sup>c</sup></b>    | Back Window (Encap)(Slider)(Solar) (OE) .....   | <b>13.7x54.0</b> |
| <b>DB10500<sup>c</sup></b>    | Back Window (Solar) (Stationary) .....  | <b>13.7x54.0</b> |

<sup>a</sup> Urethane,Dam,Primer - 2 Tubes  
<sup>b</sup> Fast-Cure Urethane/Dam/Primer - Quantity 2  
<sup>c</sup> Urethane,Dam,Primer - 1.5 Tubes  
<sup>d</sup> Urethane,Dam,Primer - 1 Tube

**Canyon 2 Door Standard Cab..... 2006-2011**

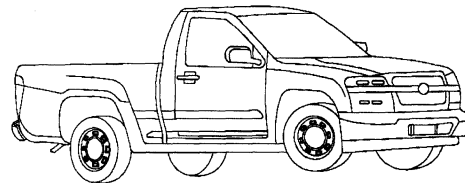

|                              |   |                  |
|------------------------------|---|------------------|
| <b>DW01533<sup>a,b</sup></b> | Windshield .....  | <b>32.0x57.4</b> |
| <b>DD10498-99</b>            | Door F/R-L .....  | <b>21.0x34.0</b> |
| <b>DY90108<sup>c</sup></b>   | Back Window (Encap)(Slider)(Solar) (Black Frame, Aftermarket, Power, 3 Panel Encapsulated) .....  | <b>13.7x54.0</b> |
| <b>DY90107<sup>c</sup></b>   | Back Window (Encap)(Slider)(Solar) (Black Frame, Aftermarket, Manual, 3 Panel Encapsulated) ..... | <b>13.7x54.0</b> |
| <b>DB10507<sup>c</sup></b>   | Back Window (Encap)(Slider)(Solar) (OE) .....   | <b>13.7x54.0</b> |
| <b>DB10500<sup>c</sup></b>   | Back Window (Solar) (Stationary) .....  | <b>13.7x54.0</b> |

<sup>a</sup> Urethane,Dam,Primer - 2 Tubes  
<sup>b</sup> Fast-Cure Urethane/Dam/Primer - Quantity 2  
<sup>c</sup> Urethane,Dam,Primer - 1.5 Tubes

**Acadia 4 Door Utility..... 2007-2011**

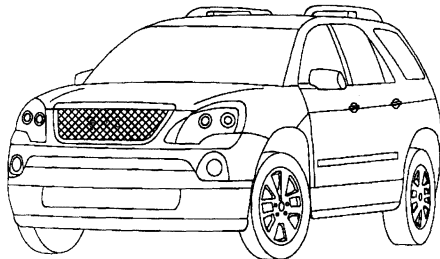

|                               |  |                  |
|-------------------------------|--|------------------|
| <b>DW01713<sup>a,b</sup></b>  | Windshield (HUD)(Solar) (W/Third Visor Frit) (08-11) ..... | <b>40.0x64.0</b> |
| <b>DW01712<sup>a,b</sup></b>  | Windshield (Solar) (W/Third Visor Frit) (08-11) .....      | <b>40.0x64.0</b> |
| <b>DW01680<sup>a,b</sup></b>  | Windshield (HUD)(Solar) (W/Third Visor Frit) (07) ...      | <b>40.0x64.0</b> |
| <b>DW01679<sup>a,b</sup></b>  | Windshield (Solar) (W/Third Visor Frit) (07) .....         | <b>40.0x64.0</b> |
| <b>DD11267-68</b>             | Door F/R-L (Solar) .....                                   | <b>27.5x33.5</b> |
| <b>DD11269-70</b>             | Door R/R-L (Solar) .....                                   | <b>24.0x29.5</b> |
| <b>DQ11274-75<sup>d</sup></b> | Quarter R-L (Solar) .....                                  | <b>17.5x35.0</b> |
| <b>DB11276<sup>c</sup></b>    | Back Window (Heated)(Solar) .....                          | <b>16.5x52.0</b> |

<sup>a</sup> Urethane,Dam,Primer - 2 Tubes  
<sup>b</sup> Fast-Cure Urethane/Dam/Primer - Quantity 2  
<sup>c</sup> Urethane,Dam,Primer - 1.5 Tubes  
<sup>d</sup> Urethane,Dam,Primer - 1 Tube

**Canyon 4 Door Crew Cab..... 2006-2011**

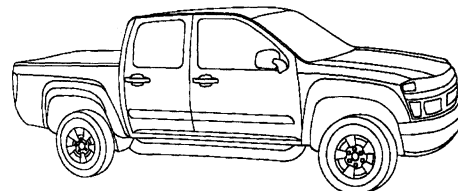

|                              |   |                  |
|------------------------------|---|------------------|
| <b>DW01533<sup>a,b</sup></b> | Windshield .....  | <b>32.0x57.4</b> |
| <b>DD10498-99</b>            | Door F/R-L .....  | <b>21.0x34.0</b> |
| <b>DD10505-06</b>            | Door R/R-L (Solar) .....  | <b>21.0x24.0</b> |
| <b>DY90108<sup>c</sup></b>   | Back Window (Encap)(Slider)(Solar) (Black Frame, Aftermarket, Power, 3 Panel Encapsulated) .....  | <b>13.7x54.0</b> |
| <b>DY90107<sup>c</sup></b>   | Back Window (Encap)(Slider)(Solar) (Black Frame, Aftermarket, Manual, 3 Panel Encapsulated) ..... | <b>13.7x54.0</b> |
| <b>DB10507<sup>c</sup></b>   | Back Window (Encap)(Slider)(Solar) (OE) .....   | <b>13.7x54.0</b> |
| <b>DB10500<sup>c</sup></b>   | Back Window (Solar) (Stationary) .....  | <b>13.7x54.0</b> |

**Canyon (cont.)**

- <sup>a</sup> Urethane,Dam,Primer - 2 Tubes
- <sup>b</sup> Fast-Cure Urethane/Dam/Primer - Quantity 2
- <sup>c</sup> Urethane,Dam,Primer - 1.5 Tubes

|                                       |                  |
|---------------------------------------|------------------|
| <b>Envoy SLT 4 Door Utility</b> ..... | <b>2006-2009</b> |
| <b>Envoy SLE 4 Door Utility</b> ..... | <b>2006-2009</b> |

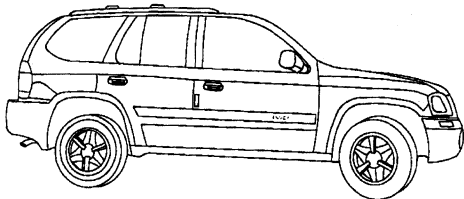

|   |                  |
|---|------------------|
| <b>DW01611<sup>bcd</sup></b> Windshield (Solar) (W/Third Visor Frit, Acoustic Inter-layer, Rain Sensor) ..... | <b>33.4x59.6</b> |
| <b>DW01610<sup>bcd</sup></b> Windshield (Solar) (W/Third Visor Frit, Acoustic Inter-layer) .....              | <b>33.4x59.6</b> |
| <b>DW01585<sup>acd</sup></b> Windshield (Solar) (W/Third Visor Frit, Rain Sensor) .....                       | <b>33.4x59.6</b> |
| <b>DW01584<sup>acd</sup></b> Windshield (Solar) (W/Third Visor Frit) .....                                    | <b>33.4x59.6</b> |
| <b>DW01446<sup>cd</sup></b> Windshield (Export Only, Rain Sensor) .....                                       | <b>33.4x59.6</b> |
| <b>DW01445<sup>cd</sup></b> Windshield (Export Only) .....  | <b>33.4x59.6</b> |
| <b>DD09965-66</b> Door F/R-L (Solar) .....  | <b>21.5x34.0</b> |
| <b>DD09967-68</b> Door R/R-L (Solar) .....  | <b>18.5x21.5</b> |
| <b>DQ10561-62<sup>e</sup></b> Quarter R-L (Encap)(Solar) .....  | <b>20.3x35.3</b> |
| <b>DV09971-72</b> Vent R/R-L (Encap)(Solar) .....   | <b>10.5x20.0</b> |
| <b>DB09983</b> Back Window (Heated)(Solar) (Movable) .....  | <b>26.0x54.0</b> |
| <b>DB09982</b> Back Window (Solar) (Movable) .....  | <b>26.0x54.0</b> |

- <sup>a</sup> Not On Production Vehicles
- <sup>b</sup> On Production Vehicles
- <sup>c</sup> Urethane,Dam,Primer - 2 Tubes
- <sup>d</sup> Fast-Cure Urethane/Dam/Primer - Quantity 2
- <sup>e</sup> Urethane,Dam,Primer - 1.5 Tubes

**Envoy DENALI 4 Door Utility**..... **2006-2009**

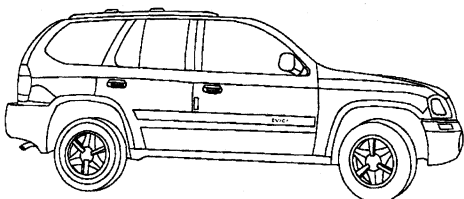

|   |                  |
|---|------------------|
| <b>DW01611<sup>bcd</sup></b> Windshield (Solar) (W/Third Visor Frit, Acoustic Inter-layer, Rain Sensor) ..... | <b>33.4x59.6</b> |
| <b>DW01585<sup>acd</sup></b> Windshield (Solar) (W/Third Visor Frit, Rain Sensor) .....                       | <b>33.4x59.6</b> |
| <b>DW01584<sup>acd</sup></b> Windshield (Solar) (W/Third Visor Frit) .....                                    | <b>33.4x59.6</b> |
| <b>DW01556<sup>bcd</sup></b> Windshield (Solar) (W/Third Visor Frit, Acoustic Inter-layer) .....              | <b>33.4x59.6</b> |
| <b>DD10574-75</b> Door F/R-L (Solar) (Laminated) .....  | <b>21.5x34.0</b> |
| <b>DD09967-68</b> Door R/R-L (Solar) .....  | <b>18.5x21.5</b> |
| <b>DQ10561-62<sup>e</sup></b> Quarter R-L (Encap)(Solar) .....  | <b>20.3x35.3</b> |
| <b>DV09971-72</b> Vent R/R-L (Encap)(Solar) .....   | <b>10.5x20.0</b> |
| <b>DB09983</b> Back Window (Heated)(Solar) (Movable) .....  | <b>26.0x54.0</b> |
| <b>DB09982</b> Back Window (Solar) (Movable) .....  | <b>26.0x54.0</b> |

- <sup>a</sup> Not On Production Vehicles
- <sup>b</sup> On Production Vehicles
- <sup>c</sup> Urethane,Dam,Primer - 2 Tubes
- <sup>d</sup> Fast-Cure Urethane/Dam/Primer - Quantity 2
- <sup>e</sup> Urethane,Dam,Primer - 1.5 Tubes

**Envoy XL DENALI 4 Door Utility**..... **2006**

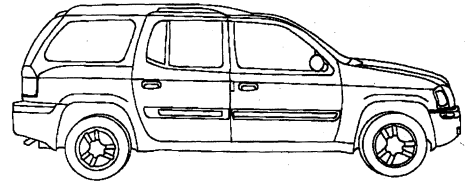

|   |                  |
|---|------------------|
| <b>DW01611<sup>bcd</sup></b> Windshield (Solar) (W/Third Visor Frit, Acoustic Inter-layer, Rain Sensor) ..... | <b>33.4x59.6</b> |
| <b>DW01585<sup>acd</sup></b> Windshield (Solar) (W/Third Visor Frit, Rain Sensor) .....                       | <b>33.4x59.6</b> |
| <b>DW01584<sup>acd</sup></b> Windshield (Solar) (W/Third Visor Frit) .....                                    | <b>33.4x59.6</b> |
| <b>DW01556<sup>bcd</sup></b> Windshield (Solar) (W/Third Visor Frit, Acoustic Inter-layer) .....              | <b>33.4x59.6</b> |
| <b>DD10574-75</b> Door F/R-L (Solar) (Laminated) .....  | <b>21.5x34.0</b> |
| <b>DD10305-06</b> Door R/R-L (Solar) .....  | <b>22.0x22.8</b> |
| <b>DQ10906-07<sup>e</sup></b> Quarter R-L (Encap)(Solar) (Stationary) .....                                   | <b>17.2x38.0</b> |
| <b>DQ10567-68<sup>e</sup></b> Quarter R-L (Encap)(1 Holes)(Solar) (Movable) .....                             | <b>17.2x38.0</b> |
| <b>DV10312-13</b> Vent R/R-L (Encap)(Solar) .....   | <b>8.0x18.8</b>  |
| <b>DB11124</b> Back Window (2 Holes)(Solar) (Movable) .....   | <b>28.5x55.0</b> |
| <b>DB10317</b> Back Window (Heated)(2 Holes)(Solar) .....   | <b>28.5x55.0</b> |

- <sup>a</sup> Not On Production Vehicles
- <sup>b</sup> On Production Vehicles
- <sup>c</sup> Urethane,Dam,Primer - 2 Tubes
- <sup>d</sup> Fast-Cure Urethane/Dam/Primer - Quantity 2
- <sup>e</sup> Urethane,Dam,Primer - 1.5 Tubes

**Envoy XL SLT 4 Door Utility**..... **2006**

**Envoy XL SLE 4 Door Utility**..... **2006**

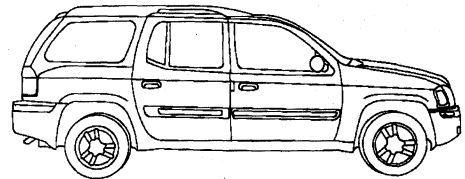

|   |                  |
|---|------------------|
| <b>DW01611<sup>bcd</sup></b> Windshield (Solar) (W/Third Visor Frit, Acoustic Inter-layer, Rain Sensor) ..... | <b>33.4x59.6</b> |
| <b>DW01610<sup>bcd</sup></b> Windshield (Solar) (W/Third Visor Frit, Acoustic Inter-layer) .....              | <b>33.4x59.6</b> |
| <b>DW01585<sup>acd</sup></b> Windshield (Solar) (W/Third Visor Frit, Rain Sensor) .....                       | <b>33.4x59.6</b> |
| <b>DW01584<sup>acd</sup></b> Windshield (Solar) (W/Third Visor Frit) .....                                    | <b>33.4x59.6</b> |
| <b>DW01446<sup>cd</sup></b> Windshield (Export Only, Rain Sensor) .....                                       | <b>33.4x59.6</b> |
| <b>DW01445<sup>cd</sup></b> Windshield (Export Only) .....  | <b>33.4x59.6</b> |
| <b>DD10574-75</b> Door F/R-L (Solar) (Laminated) .....  | <b>21.5x34.0</b> |
| <b>DD10305-06</b> Door R/R-L (Solar) .....  | <b>22.0x22.8</b> |
| <b>DQ10906-07<sup>e</sup></b> Quarter R-L (Encap)(Solar) (Stationary) .....                                   | <b>17.2x38.0</b> |
| <b>DQ10567-68<sup>e</sup></b> Quarter R-L (Encap)(1 Holes)(Solar) (Movable) .....                             | <b>17.2x38.0</b> |
| <b>DV10312-13</b> Vent R/R-L (Encap)(Solar) .....   | <b>8.0x18.8</b>  |
| <b>DB11124</b> Back Window (2 Holes)(Solar) (Movable) .....   | <b>28.5x55.0</b> |
| <b>DB10317</b> Back Window (Heated)(2 Holes)(Solar) .....   | <b>28.5x55.0</b> |

- <sup>a</sup> Not On Production Vehicles
- <sup>b</sup> On Production Vehicles
- <sup>c</sup> Urethane,Dam,Primer - 2 Tubes
- <sup>d</sup> Fast-Cure Urethane/Dam/Primer - Quantity 2
- <sup>e</sup> Urethane,Dam,Primer - 1.5 Tubes

**Envoy XUV 4 Door Utility ..... 2006**

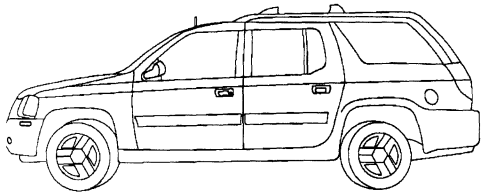

|   |           |
|---|-----------|
| DW01611 <sup>b c d</sup> Windshield (Solar) (W/Third Visor Frit, Acoustic Inter-layer, Rain Sensor) ..... | 33.4x59.6 |
| DW01610 <sup>b c d</sup> Windshield (Solar) (W/Third Visor Frit, Acoustic Inter-layer) .....              | 33.4x59.6 |
| DW01585 <sup>a c d</sup> Windshield (Solar) (W/Third Visor Frit, Rain Sensor) .....                       | 33.4x59.6 |
| DW01584 <sup>a c d</sup> Windshield (Solar) (W/Third Visor Frit) .....                                    | 33.4x59.6 |
| DW01446 <sup>c d</sup> Windshield (Export Only, Rain Sensor) .....  | 33.4x59.6 |
| DW01445 <sup>c d</sup> Windshield (Export Only) .....   | 33.4x59.6 |
| DD09965-66 Door F/R-L (Solar) .....   | 21.5x34.0 |
| DD10305-06 Door R/R-L (Solar) .....   | 22.0x22.8 |
| DQ10604-05 <sup>e</sup> Quarter R-L (Solar) .....   | 18.5x44.8 |
| DV10312-13 Vent R/R-L (Encap)(Solar) .....  | 8.0x18.8  |
| DB10606 Back Window (Heated)(Solar) .....   | 25.3x45.1 |

- <sup>a</sup> Not On Production Vehicles
- <sup>b</sup> On Production Vehicles
- <sup>c</sup> Urethane,Dam,Primer - 2 Tubes
- <sup>d</sup> Fast-Cure Urethane/Dam/Primer - Quantity 2
- <sup>e</sup> Urethane,Dam,Primer - 1.5 Tubes

**Savana Extended Van ..... 2006-2011**

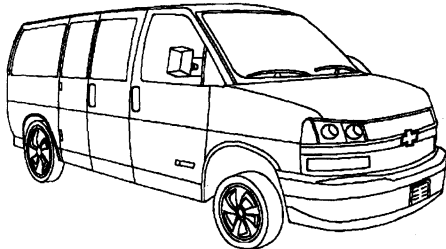

|  |           |
|--|-----------|
| DW01581 <sup>a e f</sup> Windshield (Solar) (W/O Bracket, W/Third Visor Frit) .....                                      | 39.0x73.0 |
| DW01580 <sup>a e f</sup> Windshield (Solar) (W/Third Visor Frit, W/Bracket) ..   | 39.0x73.0 |
| DD08994-95 Door F/R-L (Solar) .....  | 26.0x31.6 |
| DD10348 Door R/L (1 Holes)(Solar) (Rear, Body Side, Movable) .....   | 23.5x28.5 |
| DD10347 <sup>d</sup> Door R/L (Solar) (Stationary, Body Side, Front) .....   | 23.5x25.5 |
| DD11430 <sup>d</sup> Door R/R (Solar) (Laminated, Stationary, Sliding Cargo Door, Front) (From 07/01/2007) (07-11) ..... | 23.5x25.4 |
| DD10355-56 <sup>d</sup> Door R/R-L (Solar) (Stationary, Hinged Body Side Door, Rear) .....                               | 21.4x23.5 |
| DD10353-54 <sup>d</sup> Door R/R-L (Solar) (Stationary, Hinged Body Side Door, Front) .....                              | 23.5x25.5 |
| DD10351-52 Door R/R-L (1 Holes)(Solar) (Hinged Body Side Door, Rear, Movable) .....                                      | 21.5x23.5 |
| DD10349-50 Door R/R-L (1 Holes)(Solar) (Hinged Body Side Door, Movable, Front) .....                                     | 23.5x25.5 |
| DD10346 Door R/R (1 Holes)(Solar) (Rear, Sliding Cargo Door, Movable) .....  | 23.5x25.0 |
| DD10345 <sup>c</sup> Door R/R (Solar) (Stationary, Sliding Cargo Door, Front) (To 07/01/2007) (06-07) .....              | 23.5x25.4 |
| DD10344 <sup>b</sup> Door R/R (Solar) (Stationary, Sliding Cargo Door) .....   | 23.8x50.3 |
| DQ11429 <sup>b</sup> Quarter L (Solar) (Laminated, W/Rear A/C) (From 07/01/2007) (07-11) .....                           | 23.7x72.9 |
| DQ10370 <sup>b</sup> Quarter L (Solar) .....   | 23.7x72.9 |
| DQ10369 <sup>b</sup> Quarter L (Solar) (W/Rear A/C) (To 07/01/2007) (06-07) .....  | 23.7x72.9 |

**Savana (cont.)**

|  |           |
|--|-----------|
| DQ11428 <sup>b</sup> Quarter R (Solar) (Laminated) (From 07/01/2007) (07-11) ..... | 23.7x72.9 |
| DQ10368 <sup>b</sup> Quarter R (Solar) (To 07/01/2007) (06-07) .....               | 23.7x72.9 |
| DB11383-84 Back Window R-L (Heated)(3 Holes)(Solar) (Movable) (08-11) .....        | 24.3x27.5 |
| DB10363-64 Back Window R-L (Heated)(3 Holes)(Solar) (Movable) (06-07) .....        | 24.3x27.5 |
| DB10361-62 Back Window R-L (3 Holes)(Solar) (Movable) .....                        | 24.3x27.5 |
| DB10359-60 <sup>d</sup> Back Window R-L (Heated)(Solar) (Stationary) .....         | 24.3x27.5 |
| DB10357-58 <sup>d</sup> Back Window R-L (Solar) (Stationary) .....                 | 24.3x27.5 |

- <sup>a</sup> May Require Two Person Installation
- <sup>b</sup> Urethane,Dam,Primer - 2 Tubes
- <sup>c</sup> Urethane,Dam,Primer - 1.5 Tubes
- <sup>d</sup> Urethane,Dam,Primer - 1 Tube
- <sup>e</sup> Urethane,Dam,Primer - 2.5 Tubes
- <sup>f</sup> Fast-Cure Urethane/Dam/Primer - Quantity 2.5

**Savana Van ..... 2006-2011**

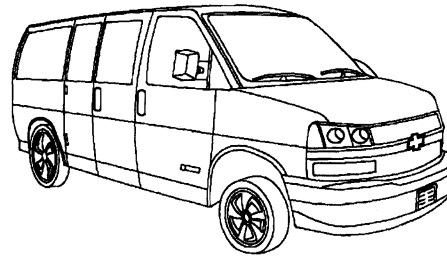

|  |           |
|--|-----------|
| DW01581 <sup>a d e</sup> Windshield (Solar) (W/O Bracket, W/Third Visor Frit) .....                                      | 39.0x73.0 |
| DW01580 <sup>a d e</sup> Windshield (Solar) (W/Third Visor Frit, W/Bracket) ..   | 39.0x73.0 |
| DD08994-95 Door F/R-L (Solar) .....  | 26.0x31.6 |
| DD10348 Door R/L (1 Holes)(Solar) (Rear, Body Side, Movable) .....   | 23.5x28.5 |
| DD10347 <sup>c</sup> Door R/L (Solar) (Stationary, Body Side, Front) .....   | 23.5x25.5 |
| DD11430 <sup>c</sup> Door R/R (Solar) (Laminated, Stationary, Sliding Cargo Door, Front) (From 07/01/2007) (07-11) ..... | 23.5x25.4 |
| DD10355-56 <sup>c</sup> Door R/R-L (Solar) (Stationary, Hinged Body Side Door, Rear) .....                               | 21.4x23.5 |
| DD10353-54 <sup>c</sup> Door R/R-L (Solar) (Stationary, Hinged Body Side Door, Front) .....                              | 23.5x25.5 |
| DD10351-52 Door R/R-L (1 Holes)(Solar) (Hinged Body Side Door, Rear, Movable) .....                                      | 21.5x23.5 |
| DD10349-50 Door R/R-L (1 Holes)(Solar) (Hinged Body Side Door, Movable, Front) .....                                     | 23.5x25.5 |
| DD10346 Door R/R (1 Holes)(Solar) (Rear, Sliding Cargo Door, Movable) .....  | 23.5x25.0 |
| DD10345 <sup>c</sup> Door R/R (Solar) (Stationary, Sliding Cargo Door, Front) (To 07/01/2007) (06-07) .....              | 23.5x25.4 |
| DD10344 <sup>b</sup> Door R/R (Solar) (Stationary, Sliding Cargo Door) .....   | 23.8x50.3 |
| DQ11427 <sup>b</sup> Quarter L (Solar) (Laminated, W/Rear A/C) (From 07/01/2007) (07-11) .....                           | 23.5x54.8 |
| DQ10374 <sup>b</sup> Quarter L (Solar) (W/60-40 Side Doors, W/Rear A/C) .....  | 23.5x54.7 |
| DQ10373 <sup>b</sup> Quarter L (Solar) (W/60-40 Side Doors) .....  | 23.5x54.7 |
| DQ10367 <sup>b</sup> Quarter L (Solar) .....   | 23.5x54.8 |
| DQ10366 <sup>b</sup> Quarter L (Solar) (W/Rear A/C) (To 07/01/2007) (06-07) .....  | 23.5x54.8 |
| DQ11426 <sup>b</sup> Quarter R (Solar) (Laminated) (From 07/01/2007) (07-11) .....                                       | 23.5x54.8 |
| DQ10365 <sup>b</sup> Quarter R (Solar) (To 07/01/2007) (06-07) .....   | 23.5x54.8 |
| DB11383-84 Back Window R-L (Heated)(3 Holes)(Solar) (Movable) (08-11) .....  | 24.3x27.5 |
| DB10363-64 Back Window R-L (Heated)(3 Holes)(Solar) (Movable) (06-07) .....  | 24.3x27.5 |
| DB10361-62 Back Window R-L (3 Holes)(Solar) (Movable) .....  | 24.3x27.5 |
| DB10359-60 <sup>c</sup> Back Window R-L (Heated)(Solar) (Stationary) .....   | 24.3x27.5 |
| DB10357-58 <sup>c</sup> Back Window R-L (Solar) (Stationary) .....   | 24.3x27.5 |

- <sup>a</sup> May Require Two Person Installation
- <sup>b</sup> Urethane,Dam,Primer - 1.5 Tubes



**Savana** (cont.)

<sup>c</sup> Urethane,Dam,Primer - 1 Tube  
<sup>d</sup> Urethane,Dam,Primer - 2.5 Tubes  
<sup>e</sup> Fast-Cure Urethane/Dam/Primer - Quantity 2.5

|   |                  |
|---|------------------|
| <b>Sierra C2500 2 Door Extended Cab</b> ..... | <b>2007-2011</b> |
| <b>Sierra K1500 2 Door Extended Cab</b> ..... | <b>2007-2011</b> |
| <b>Sierra C1500 2 Door Extended Cab</b> ..... | <b>2007-2011</b> |
| <b>Sierra K2500 2 Door Extended Cab</b> ..... | <b>2007-2011</b> |
| <b>Sierra C3500 2 Door Extended Cab</b> ..... | <b>2007-2011</b> |
| <b>Sierra K3500 2 Door Extended Cab</b> ..... | <b>2007-2011</b> |

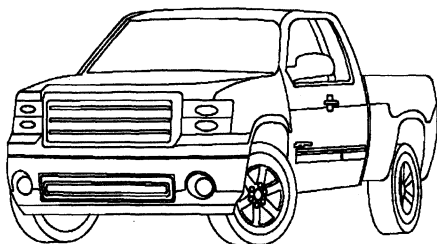

|  |                  |
|--|------------------|
| <b>DW01883<sup>a f g</sup></b> Windshield (Solar) (W/Third Visor Frit, Acoustic Inter-layer) (11) .....                      | <b>31.0x67.0</b> |
| <b>DW01658<sup>b c f g</sup></b> Windshield (Solar) (W/Third Visor Frit) .....   | <b>33.5x67.8</b> |
| <b>DD11163-64</b> Door F/R-L (Solar) .....   | <b>26.8x32.5</b> |
| <b>DQ11174-75</b> Quarter R-L (Solar) (Movable) .....  | <b>18.0x22.0</b> |
| <b>DB11388</b> Back Window C (Slider)(Solar) (OE, Power) .....   | <b>13.0x16.0</b> |
| <b>DB11386</b> Back Window C (Slider)(Solar) (OE, Manual) .....  | <b>13.0x16.0</b> |
| <b>DY90115<sup>f</sup></b> Back Window (Slider)(Solar) (Aftermarket, 1 Panel Flush Fit, Manual) .....                        | <b>17.5x64.3</b> |
| <b>DY90097<sup>f</sup></b> Back Window (Encap)(Slider)(Solar) (Aftermarket, Power, Curved, 3 Panel Encapsulated) .....       | <b>18.1x64.8</b> |
| <b>DY90096<sup>f</sup></b> Back Window (Encap)(Slider) (Aftermarket, Curved, Manual, 3 Panel Encapsulated) .....             | <b>18.1x64.8</b> |
| <b>DY90095<sup>f</sup></b> Back Window (Encap)(Slider)(Solar) (Aftermarket, Curved, Manual, 3 Panel Encapsulated) .....      | <b>18.1x64.8</b> |
| <b>DY90092<sup>f</sup></b> Back Window (Encap)(Slider) (Black Frame, Aftermarket, Manual, 3 Panel Encapsulated) .....        | <b>18.1x64.8</b> |
| <b>DY90091<sup>f</sup></b> Back Window (Encap)(Slider)(Solar) (Black Frame, Aftermarket, Manual, 3 Panel Encapsulated) ..... | <b>18.1x64.8</b> |
| <b>DY90090<sup>f</sup></b> Back Window (Encap)(Slider)(Solar) (Black Frame, Aftermarket, Power, 3 Panel Encapsulated) .....  | <b>18.1x64.8</b> |
| <b>DB11915<sup>e f</sup></b> Back Window (Slider)(Solar) (OE, Power) (11) .....  | <b>17.5x64.3</b> |
| <b>DB11914<sup>d f</sup></b> Back Window (Slider)(Solar) (Manual) (11) .....   | <b>17.5x64.3</b> |
| <b>DB11387<sup>f</sup></b> Back Window (Slider)(Solar) (OE, Power) (07-10) .....   | <b>17.5x64.3</b> |
| <b>DB11178<sup>f</sup></b> Back Window (Slider)(Solar) (Manual) (07-10) .....  | <b>17.5x64.3</b> |
| <b>DB11177<sup>f</sup></b> Back Window (Heated)(Solar) (Stationary) .....  | <b>17.5x64.3</b> |
| <b>DB11176<sup>f</sup></b> Back Window (Solar) (Stationary) .....  | <b>17.5x64.3</b> |

<sup>a</sup> On Production Vehicles  
<sup>b</sup> Not On Production Vehicles 2011 Up  
<sup>c</sup> On Production Vehicles 2007-2010  
<sup>d</sup> Lower Corners Changed From DB11178  
<sup>e</sup> Lower Corners Changed From DB11387  
<sup>f</sup> Urethane,Dam,Primer - 2 Tubes  
<sup>g</sup> Fast-Cure Urethane/Dam/Primer - Quantity 2

|   |             |
|---|-------------|
| <b>Sierra K1500CLSC 2 Door Extended Cab</b> ..... | <b>2007</b> |
| <b>Sierra K3500CLSC 2 Door Extended Cab</b> ..... | <b>2007</b> |
| <b>Sierra C2500CLSC 2 Door Extended Cab</b> ..... | <b>2007</b> |
| <b>Sierra C3500CLSC 2 Door Extended Cab</b> ..... | <b>2007</b> |
| <b>Sierra K2500CLSC 2 Door Extended Cab</b> ..... | <b>2007</b> |
| <b>Sierra C1500CLSC 2 Door Extended Cab</b> ..... | <b>2007</b> |
| <b>Sierra C3500 2 Door Extended Cab</b> .....     | <b>2006</b> |
| <b>Sierra C1500 2 Door Extended Cab</b> .....     | <b>2006</b> |
| <b>Sierra K3500 2 Door Extended Cab</b> .....     | <b>2006</b> |
| <b>Sierra K2500 HD 2 Door Extended Cab</b> .....  | <b>2006</b> |
| <b>Sierra C2500 HD 2 Door Extended Cab</b> .....  | <b>2006</b> |
| <b>Sierra K1500 2 Door Extended Cab</b> .....     | <b>2006</b> |

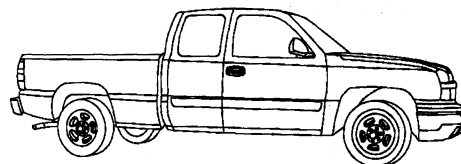

|  |                  |
|--|------------------|
| <b>DW01736<sup>a c d</sup></b> Windshield (Solar) (W/Third Visor Frit, Aftermarket, Solar Coated) (06-07) .....                      | <b>31.5x69.1</b> |
| <b>DW01549<sup>b c d</sup></b> Windshield (Solar) (W/Third Visor Frit) (06-07) .....   | <b>31.5x69.1</b> |
| <b>DD09479-80</b> Door F/R-L (Solar) (06-07) .....   | <b>26.4x32.4</b> |
| <b>DQ09481-82<sup>c</sup></b> Quarter R-L (Solar) (Movable) (06-07) .....  | <b>20.0x21.0</b> |
| <b>DY90112<sup>c</sup></b> Back Window (Slider)(Solar) (Aftermarket, 1 Panel Flush Fit, Manual) (06-07) .....                        | <b>18.1x64.8</b> |
| <b>DY90097<sup>c</sup></b> Back Window (Encap)(Slider)(Solar) (Aftermarket, Power, Curved, 3 Panel Encapsulated) (06-07) .....       | <b>18.1x64.8</b> |
| <b>DY90096<sup>c</sup></b> Back Window (Encap)(Slider) (Aftermarket, Curved, Manual, 3 Panel Encapsulated) (06-07) .....             | <b>18.1x64.8</b> |
| <b>DY90095<sup>c</sup></b> Back Window (Encap)(Slider)(Solar) (Aftermarket, Curved, Manual, 3 Panel Encapsulated) (06-07) .....      | <b>18.1x64.8</b> |
| <b>DY90092<sup>c</sup></b> Back Window (Encap)(Slider) (Black Frame, Aftermarket, Manual, 3 Panel Encapsulated) (06-07) .....        | <b>18.1x64.8</b> |
| <b>DY90091<sup>c</sup></b> Back Window (Encap)(Slider)(Solar) (Black Frame, Aftermarket, Manual, 3 Panel Encapsulated) (06-07) ..... | <b>18.1x64.8</b> |
| <b>DY90090<sup>c</sup></b> Back Window (Encap)(Slider)(Solar) (Black Frame, Aftermarket, Power, 3 Panel Encapsulated) (06-07) .....  | <b>18.1x64.8</b> |
| <b>DB09795<sup>c</sup></b> Back Window (Encap)(Slider)(Solar) (OE) (06-07) .....   | <b>17.7x63.9</b> |
| <b>DB09484<sup>c</sup></b> Back Window (Solar) (Stationary) (06-07) .....  | <b>17.7x63.9</b> |
| <b>DB09483<sup>c</sup></b> Back Window (Heated)(Solar) (Stationary) (06-07) .....  | <b>17.7x63.9</b> |

<sup>a</sup> Not On Production Vehicles  
<sup>b</sup> On Production Vehicles  
<sup>c</sup> Urethane,Dam,Primer - 2 Tubes  
<sup>d</sup> Fast-Cure Urethane/Dam/Primer - Quantity 2  
<sup>e</sup> Urethane,Dam,Primer - 1 Tube

|   |                  |
|---|------------------|
| <b>Sierra C2500 2 Door Standard Cab</b> ..... | <b>2007-2011</b> |
| <b>Sierra K2500 2 Door Standard Cab</b> ..... | <b>2007-2011</b> |
| <b>Sierra K3500 2 Door Standard Cab</b> ..... | <b>2007-2011</b> |
| <b>Sierra K1500 2 Door Standard Cab</b> ..... | <b>2007-2011</b> |
| <b>Sierra C1500 2 Door Standard Cab</b> ..... | <b>2007-2011</b> |
| <b>Sierra C3500 2 Door Standard Cab</b> ..... | <b>2007-2011</b> |

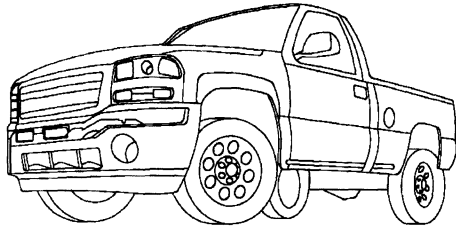

|  |                  |
|--|------------------|
| <b>DW01883<sup>a e f</sup></b> Windshield (Solar) (W/Third Visor Frit, Acoustic Inter-layer) (11) .....                      | <b>31.0x67.0</b> |
| <b>DW01658<sup>b c e f</sup></b> Windshield (Solar) (W/Third Visor Frit) .....   | <b>33.5x67.8</b> |
| <b>DD11163-64</b> Door F/R-L (Solar) .....   | <b>26.8x32.5</b> |
| <b>DB11386</b> Back Window C (Slider)(Solar) (OE, Manual) .....  | <b>13.0x16.0</b> |
| <b>DY90115<sup>e</sup></b> Back Window (Slider)(Solar) (Aftermarket, 1 Panel Flush Fit, Manual) .....                        | <b>17.5x64.3</b> |
| <b>DY90097<sup>e</sup></b> Back Window (Encap)(Slider)(Solar) (Aftermarket, Power, Curved, 3 Panel Encapsulated) .....       | <b>18.1x64.8</b> |
| <b>DY90096<sup>e</sup></b> Back Window (Encap)(Slider) (Aftermarket, Curved, Manual, 3 Panel Encapsulated) .....             | <b>18.1x64.8</b> |
| <b>DY90095<sup>e</sup></b> Back Window (Encap)(Slider)(Solar) (Aftermarket, Curved, Manual, 3 Panel Encapsulated) .....      | <b>18.1x64.8</b> |
| <b>DY90092<sup>e</sup></b> Back Window (Encap)(Slider) (Black Frame, Aftermarket, Manual, 3 Panel Encapsulated) .....        | <b>18.1x64.8</b> |
| <b>DY90091<sup>e</sup></b> Back Window (Encap)(Slider)(Solar) (Black Frame, Aftermarket, Manual, 3 Panel Encapsulated) ..... | <b>18.1x64.8</b> |
| <b>DY90090<sup>e</sup></b> Back Window (Encap)(Slider)(Solar) (Black Frame, Aftermarket, Power, 3 Panel Encapsulated) .....  | <b>18.1x64.8</b> |
| <b>DB11914<sup>d e</sup></b> Back Window (Slider)(Solar) (Manual) (11) .....   | <b>17.5x64.3</b> |
| <b>DB11178<sup>e</sup></b> Back Window (Slider)(Solar) (Manual) (07-10) .....  | <b>17.5x64.3</b> |
| <b>DB11177<sup>e</sup></b> Back Window (Heated)(Solar) (Stationary) .....  | <b>17.5x64.3</b> |
| <b>DB11176<sup>e</sup></b> Back Window (Solar) (Stationary) .....  | <b>17.5x64.3</b> |

<sup>a</sup> On Production Vehicles  
<sup>b</sup> Not On Production Vehicles 2011 Up  
<sup>c</sup> On Production Vehicles 2007-2010  
<sup>d</sup> Lower Corners Changed From DB11178  
<sup>e</sup> Urethane, Dam, Primer - 2 Tubes  
<sup>f</sup> Fast-Cure Urethane/Dam/Primer - Quantity 2

|   |             |
|---|-------------|
| <b>Sierra K3500CLSC 2 Door Standard Cab</b> ..... | <b>2007</b> |
| <b>Sierra C2500CLSC 2 Door Standard Cab</b> ..... | <b>2007</b> |
| <b>Sierra C3500CLSC 2 Door Standard Cab</b> ..... | <b>2007</b> |
| <b>Sierra K2500CLSC 2 Door Standard Cab</b> ..... | <b>2007</b> |
| <b>Sierra C1500CLSC 2 Door Standard Cab</b> ..... | <b>2007</b> |
| <b>Sierra K1500CLSC 2 Door Standard Cab</b> ..... | <b>2007</b> |
| <b>Sierra C1500 2 Door Standard Cab</b> .....     | <b>2006</b> |
| <b>Sierra K1500 2 Door Standard Cab</b> .....     | <b>2006</b> |
| <b>Sierra C3500 2 Door Standard Cab</b> .....     | <b>2006</b> |
| <b>Sierra K3500 2 Door Standard Cab</b> .....     | <b>2006</b> |
| <b>Sierra C2500 HD 2 Door Standard Cab</b> .....  | <b>2006</b> |
| <b>Sierra K2500 HD 2 Door Standard Cab</b> .....  | <b>2006</b> |

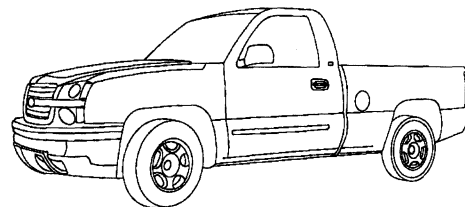

|  |                  |
|--|------------------|
| <b>DW01736<sup>a c d</sup></b> Windshield (Solar) (W/Third Visor Frit, Aftermarket, Solar Coated) (06-07) .....                      | <b>31.5x69.1</b> |
| <b>DW01549<sup>b c d</sup></b> Windshield (Solar) (W/Third Visor Frit) (06-07) .....   | <b>31.5x69.1</b> |
| <b>DD09479-80</b> Door F/R-L (Solar) (06-07) .....   | <b>26.4x32.4</b> |
| <b>DY90112<sup>c</sup></b> Back Window (Slider)(Solar) (Aftermarket, 1 Panel Flush Fit, Manual) (06-07) .....                        | <b>18.1x64.8</b> |
| <b>DY90097<sup>c</sup></b> Back Window (Encap)(Slider)(Solar) (Aftermarket, Power, Curved, 3 Panel Encapsulated) (06-07) .....       | <b>18.1x64.8</b> |
| <b>DY90096<sup>c</sup></b> Back Window (Encap)(Slider) (Aftermarket, Curved, Manual, 3 Panel Encapsulated) (06-07) .....             | <b>18.1x64.8</b> |
| <b>DY90095<sup>c</sup></b> Back Window (Encap)(Slider)(Solar) (Aftermarket, Curved, Manual, 3 Panel Encapsulated) (06-07) .....      | <b>18.1x64.8</b> |
| <b>DY90092<sup>c</sup></b> Back Window (Encap)(Slider) (Black Frame, Aftermarket, Manual, 3 Panel Encapsulated) (06-07) .....        | <b>18.1x64.8</b> |
| <b>DY90091<sup>c</sup></b> Back Window (Encap)(Slider)(Solar) (Black Frame, Aftermarket, Manual, 3 Panel Encapsulated) (06-07) ..... | <b>18.1x64.8</b> |
| <b>DY90090<sup>c</sup></b> Back Window (Encap)(Slider)(Solar) (Black Frame, Aftermarket, Power, 3 Panel Encapsulated) (06-07) .....  | <b>18.1x64.8</b> |
| <b>DB09795<sup>c</sup></b> Back Window (Encap)(Slider)(Solar) (OE) (06-07) ....  | <b>17.7x63.9</b> |
| <b>DB09484<sup>c</sup></b> Back Window (Solar) (Stationary) (06-07) .....  | <b>17.7x63.9</b> |
| <b>DB09483<sup>c</sup></b> Back Window (Heated)(Solar) (Stationary) (06-07) ....   | <b>17.7x63.9</b> |

<sup>a</sup> Not On Production Vehicles  
<sup>b</sup> On Production Vehicles  
<sup>c</sup> Urethane, Dam, Primer - 2 Tubes  
<sup>d</sup> Fast-Cure Urethane/Dam/Primer - Quantity 2

|                                    |           |
|------------------------------------|-----------|
| Sierra K1500 4 Door Crew Cab ..... | 2007-2011 |
| Sierra C1500 4 Door Crew Cab ..... | 2007-2011 |
| Sierra K3500 4 Door Crew Cab ..... | 2007-2011 |
| Sierra C3500 4 Door Crew Cab ..... | 2007-2011 |
| Sierra K2500 4 Door Crew Cab ..... | 2007-2011 |
| Sierra C2500 4 Door Crew Cab ..... | 2007-2011 |

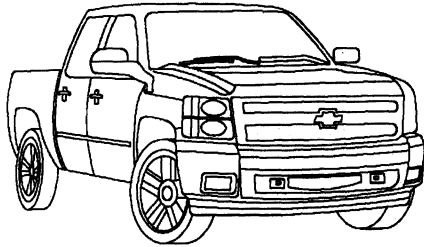

|  |           |
|--|-----------|
| DW01883 <sup>b g h</sup> Windshield (Solar) (W/Third Visor Frit, Acoustic Inter-layer) (11) .....                      | 31.0x67.0 |
| DW01659 <sup>a g h</sup> Windshield (Solar) (W/Third Visor Frit, Rain Sensor) .....                                    | 33.5x67.8 |
| DW01658 <sup>c d g h</sup> Windshield (Solar) (W/Third Visor Frit) .....   | 33.5x67.8 |
| DD11163-64 Door F/R-L (Solar) .....  | 26.8x32.5 |
| DD11169-70 Door R/R-L (Solar) .....  | 27.3x30.0 |
| DB11388 Back Window C (Slider)(Solar) (OE, Power) .....  | 13.0x16.0 |
| DB11386 Back Window C (Slider)(Solar) (OE, Manual) .....   | 13.0x16.0 |
| DY90115 <sup>g</sup> Back Window (Slider)(Solar) (Aftermarket, 1 Panel Flush Fit, Manual) .....                        | 17.5x64.3 |
| DY90097 <sup>g</sup> Back Window (Encap)(Slider)(Solar) (Aftermarket, Power, Curved, 3 Panel Encapsulated) .....       | 18.1x64.8 |
| DY90096 <sup>g</sup> Back Window (Encap)(Slider) (Aftermarket, Curved, Manual, 3 Panel Encapsulated) .....             | 18.1x64.8 |
| DY90095 <sup>g</sup> Back Window (Encap)(Slider)(Solar) (Aftermarket, Curved, Manual, 3 Panel Encapsulated) .....      | 18.1x64.8 |
| DY90092 <sup>g</sup> Back Window (Encap)(Slider) (Black Frame, Aftermarket, Manual, 3 Panel Encapsulated) .....        | 18.1x64.8 |
| DY90091 <sup>g</sup> Back Window (Encap)(Slider)(Solar) (Black Frame, Aftermarket, Manual, 3 Panel Encapsulated) ..... | 18.1x64.8 |
| DY90090 <sup>g</sup> Back Window (Encap)(Slider)(Solar) (Black Frame, Aftermarket, Power, 3 Panel Encapsulated) .....  | 18.1x64.8 |
| DB11915 <sup>f g</sup> Back Window (Slider)(Solar) (OE, Power) (11) .....  | 17.5x64.3 |
| DB11914 <sup>e g</sup> Back Window (Slider)(Solar) (Manual) (11) .....   | 17.5x64.3 |
| DB11387 <sup>g</sup> Back Window (Slider)(Solar) (OE, Power) (07-10) .....   | 17.5x64.3 |
| DB11178 <sup>g</sup> Back Window (Slider)(Solar) (Manual) (07-10) .....  | 17.5x64.3 |
| DB11177 <sup>g</sup> Back Window (Heated)(Solar) (Stationary) .....  | 17.5x64.3 |
| DB11176 <sup>g</sup> Back Window (Solar) (Stationary) .....  | 17.5x64.3 |

<sup>a</sup> May Require Replacement of Rain Sensor  
<sup>b</sup> On Production Vehicles  
<sup>c</sup> Not On Production Vehicles 2011 Up  
<sup>d</sup> On Production Vehicles 2007-2010  
<sup>e</sup> Lower Corners Changed From DB11178  
<sup>f</sup> Lower Corners Changed From DB11387  
<sup>g</sup> Urethane,Dam,Primer - 2 Tubes  
<sup>h</sup> Fast-Cure Urethane/Dam/Primer - Quantity 2

|  |      |
|--|------|
| Sierra K1500CLSC 4 Door Crew Cab ..... | 2007 |
| Sierra C1500CLSC 4 Door Crew Cab ..... | 2007 |
| Sierra C3500CLSC 4 Door Crew Cab ..... | 2007 |
| Sierra K2500CLSC 4 Door Crew Cab ..... | 2007 |
| Sierra C2500CLSC 4 Door Crew Cab ..... | 2007 |
| Sierra K3500CLSC 4 Door Crew Cab ..... | 2007 |
| Sierra K1500 4 Door Crew Cab .....     | 2006 |
| Sierra C1500 4 Door Crew Cab .....     | 2006 |
| Sierra C3500 4 Door Crew Cab .....     | 2006 |
| Sierra C2500 HD 4 Door Crew Cab .....  | 2006 |
| Sierra C1500HD 4 Door Crew Cab .....   | 2006 |
| Sierra K1500HD 4 Door Crew Cab .....   | 2006 |
| Sierra K3500 4 Door Crew Cab .....     | 2006 |
| Sierra K2500 HD 4 Door Crew Cab .....  | 2006 |

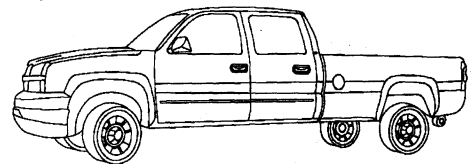

|  |           |
|--|-----------|
| DW01736 <sup>a c d</sup> Windshield (Solar) (W/Third Visor Frit, Aftermarket, Solar Coated) (06-07) .....                      | 31.5x69.1 |
| DW01549 <sup>b c d</sup> Windshield (Solar) (W/Third Visor Frit) (06-07) .....   | 31.5x69.1 |
| DD09479-80 Door F/R-L (Solar) (06-07) .....  | 26.4x32.4 |
| DD09734-35 Door R/R-L (Solar) (06-07) .....  | 26.1x30.1 |
| DY90112 <sup>c</sup> Back Window (Slider)(Solar) (Aftermarket, 1 Panel Flush Fit, Manual) (06-07) .....                        | 18.1x64.8 |
| DY90097 <sup>c</sup> Back Window (Encap)(Slider)(Solar) (Aftermarket, Power, Curved, 3 Panel Encapsulated) (06-07) .....       | 18.1x64.8 |
| DY90096 <sup>c</sup> Back Window (Encap)(Slider) (Aftermarket, Curved, Manual, 3 Panel Encapsulated) (06-07) .....             | 18.1x64.8 |
| DY90095 <sup>c</sup> Back Window (Encap)(Slider)(Solar) (Aftermarket, Curved, Manual, 3 Panel Encapsulated) (06-07) .....      | 18.1x64.8 |
| DY90092 <sup>c</sup> Back Window (Encap)(Slider) (Black Frame, Aftermarket, Manual, 3 Panel Encapsulated) (06-07) .....        | 18.1x64.8 |
| DY90091 <sup>c</sup> Back Window (Encap)(Slider)(Solar) (Black Frame, Aftermarket, Manual, 3 Panel Encapsulated) (06-07) ..... | 18.1x64.8 |
| DY90090 <sup>c</sup> Back Window (Encap)(Slider)(Solar) (Black Frame, Aftermarket, Power, 3 Panel Encapsulated) (06-07) .....  | 18.1x64.8 |
| DB09795 <sup>c</sup> Back Window (Encap)(Slider)(Solar) (OE) (06-07) .....   | 17.7x63.9 |
| DB09484 <sup>c</sup> Back Window (Solar) (Stationary) (06-07) .....  | 17.7x63.9 |
| DB09483 <sup>c</sup> Back Window (Heated)(Solar) (Stationary) (06-07) .....  | 17.7x63.9 |

<sup>a</sup> Not On Production Vehicles  
<sup>b</sup> On Production Vehicles  
<sup>c</sup> Urethane,Dam,Primer - 2 Tubes  
<sup>d</sup> Fast-Cure Urethane/Dam/Primer - Quantity 2

**Terrain 4 Door Utility .....** 2010-2011

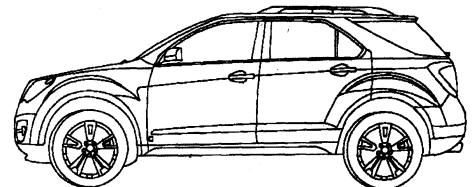

|  |           |
|--|-----------|
| DW01824 <sup>a b</sup> Windshield (Solar) (W/Third Visor Frit, Acoustic Inter-layer, W/Remote Start) ..... | 36.5x57.0 |
| DD11758-59 Door F/R-L (Solar) (Laminated) .....  | 19.0x30.5 |
| DD11772-73 Door R/R-L (Solar) .....  | 19.0x25.0 |
| DQ11776-77 <sup>d</sup> Quarter R-L (Encap)(Solar) .....   | 19.5x23.5 |

|  |                |
|--|----------------|
| <b>Terrain</b>   | <b>(cont.)</b> |
| DV11774-75 Vent R/R-L (Solar)  | 6.0x15.0       |
| DB11778 <sup>c</sup> Back Window (Heated)(1 Holes)(Solar) (W/Wiper)  | 21.0x51.5      |
| <sup>a</sup> Urethane,Dam,Primer - 2 Tubes<br><sup>b</sup> Fast-Cure Urethane/Dam/Primer - Quantity 2<br><sup>c</sup> Urethane,Dam,Primer - 1.5 Tubes<br><sup>d</sup> Urethane,Dam,Primer - 1 Tube |                |

|                                    |                  |
|------------------------------------|------------------|
| <b>Yukon 4 Door Utility</b>        | <b>2007-2011</b> |
| <b>Yukon Denali 4 Door Utility</b> | <b>2007-2011</b> |

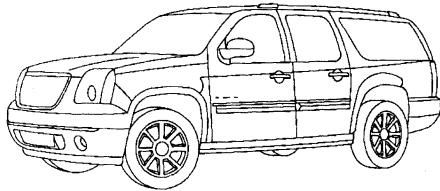

|   |           |
|---|-----------|
| DW01883 <sup>b e f</sup> Windshield (Solar) (W/Third Visor Frit, Acoustic Inter-layer) (11) | 31.0x67.0 |
| DW01659 <sup>a e f</sup> Windshield (Solar) (W/Third Visor Frit, Rain Sensor)               | 33.5x67.8 |
| DW01658 <sup>c d e f</sup> Windshield (Solar) (W/Third Visor Frit)                          | 33.5x67.8 |
| DD11163-64 Door F/R-L (Solar)   | 26.8x32.5 |
| DD11165-66 Door R/R-L (Solar)   | 26.8x30.0 |
| DQ11168 <sup>g</sup> Quarter L (Solar)  | 20.8x42.3 |
| DQ11167 <sup>g</sup> Quarter R (Ant)(Solar)   | 20.8x42.3 |
| DB11700 <sup>g</sup> Back Window (Heated)(Solar) (Hybrid) (08-11)                           | 20.0x61.0 |
| DB11173 Back Window (Heated)(3 Holes)(Solar)  | 25.0x61.5 |

- <sup>a</sup> May Require Replacement of Rain Sensor
- <sup>b</sup> On Production Vehicles
- <sup>c</sup> Not On Production Vehicles 2011 Up
- <sup>d</sup> On Production Vehicles 2007-2010
- <sup>e</sup> Urethane,Dam,Primer - 2 Tubes
- <sup>f</sup> Fast-Cure Urethane/Dam/Primer - Quantity 2
- <sup>g</sup> Urethane,Dam,Primer - 1.5 Tubes

|                                    |             |
|------------------------------------|-------------|
| <b>Yukon 4 Door Utility</b>        | <b>2006</b> |
| <b>Yukon Denali 4 Door Utility</b> | <b>2006</b> |

001I0169

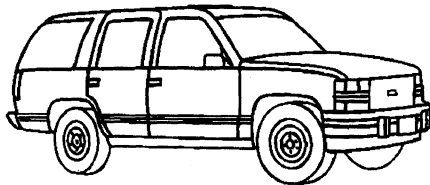

|   |           |
|---|-----------|
| DW01736 <sup>a c d</sup> Windshield (Solar) (W/Third Visor Frit, Aftermarket, Solar Coated) | 31.5x69.1 |
| DW01549 <sup>b c d</sup> Windshield (Solar) (W/Third Visor Frit)                            | 31.5x69.1 |
| DD10229-30 Door F/R-L (Solar) (Laminated)   | 26.4x32.2 |
| DD09479-80 Door F/R-L (Solar)   | 26.4x32.4 |
| DD10231-32 Door R/R-L (Solar) (Laminated)   | 23.5x32.0 |
| DD09738-39 Door R/R-L (Solar)   | 23.5x32.0 |
| DR11694 Roof (Solar)  |           |
| DQ09740-41 <sup>e</sup> Quarter R-L (Encap)(Solar)  | 20.5x35.0 |
| DB09744-45 <sup>e</sup> Back Window R-L (Encap)(Solar)                                      | 28.8x29.7 |
| DB09742-43 <sup>e</sup> Back Window R-L (Encap)(Heated)(Solar)                              | 28.8x29.7 |
| DB10829 Back Window (Heated)(Solar)   | 27.5x61.0 |

- <sup>a</sup> Not On Production Vehicles
- <sup>b</sup> On Production Vehicles
- <sup>c</sup> Urethane,Dam,Primer - 2 Tubes
- <sup>d</sup> Fast-Cure Urethane/Dam/Primer - Quantity 2
- <sup>e</sup> Urethane,Dam,Primer - 1.5 Tubes

|                                |                  |
|--------------------------------|------------------|
| <b>Yukon XL 4 Door Utility</b> | <b>2007-2011</b> |
|--------------------------------|------------------|

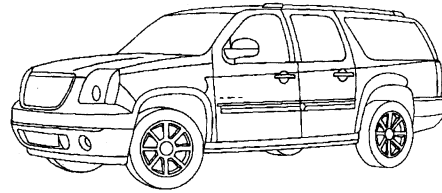

|   |           |
|---|-----------|
| DW01883 <sup>b e f</sup> Windshield (Solar) (W/Third Visor Frit, Acoustic Inter-layer) (11) | 31.0x67.0 |
| DW01659 <sup>a e f</sup> Windshield (Solar) (W/Third Visor Frit, Rain Sensor)               | 33.5x67.8 |
| DW01658 <sup>c d e f</sup> Windshield (Solar) (W/Third Visor Frit)                          | 33.5x67.8 |
| DD11163-64 Door F/R-L (Solar)   | 26.8x32.5 |
| DD11169-70 Door R/R-L (Solar)   | 27.3x30.0 |
| DQ11172 <sup>e</sup> Quarter L (Solar)  | 21.0x60.5 |
| DQ11171 <sup>e</sup> Quarter R (Ant)(Solar)   | 21.0x60.5 |
| DB11173 Back Window (Heated)(3 Holes)(Solar)  | 25.0x61.5 |

- <sup>a</sup> May Require Replacement of Rain Sensor
- <sup>b</sup> On Production Vehicles
- <sup>c</sup> Not On Production Vehicles 2011 Up
- <sup>d</sup> On Production Vehicles 2007-2010
- <sup>e</sup> Urethane,Dam,Primer - 2 Tubes
- <sup>f</sup> Fast-Cure Urethane/Dam/Primer - Quantity 2

|                                |             |
|--------------------------------|-------------|
| <b>Yukon XL 4 Door Utility</b> | <b>2006</b> |
|--------------------------------|-------------|

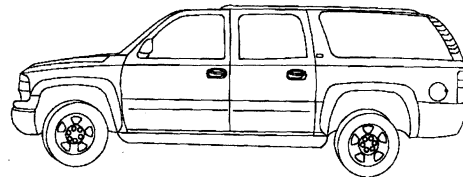

|   |           |
|---|-----------|
| DW01736 <sup>a c d</sup> Windshield (Solar) (W/Third Visor Frit, Aftermarket, Solar Coated) | 31.5x69.1 |
| DW01549 <sup>b c d</sup> Windshield (Solar) (W/Third Visor Frit)                            | 31.5x69.1 |
| DD09479-80 Door F/R-L (Solar)   | 26.4x32.4 |
| DD09734-35 Door R/R-L (Solar)   | 26.1x30.1 |
| DR11694 Roof (Solar)  |           |
| DQ09736-37 <sup>e</sup> Quarter R-L (Encap)(Solar)  | 22.0x54.0 |
| DB09744-45 <sup>e</sup> Back Window R-L (Encap)(Solar)                                      | 28.8x29.7 |
| DB09742-43 <sup>e</sup> Back Window R-L (Encap)(Heated)(Solar)                              | 28.8x29.7 |
| DB10829 Back Window (Heated)(Solar)   | 27.5x61.0 |

- <sup>a</sup> Not On Production Vehicles
- <sup>b</sup> On Production Vehicles
- <sup>c</sup> Urethane,Dam,Primer - 2 Tubes
- <sup>d</sup> Fast-Cure Urethane/Dam/Primer - Quantity 2
- <sup>e</sup> Urethane,Dam,Primer - 1.5 Tubes

|                            |                  |
|----------------------------|------------------|
| <b>Honda</b>               |                  |
| <b>Accord 2 Door Coupe</b> | <b>2008-2011</b> |

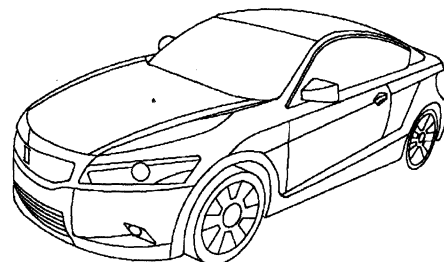

| <i>Accord</i>  | <i>(cont.)</i> |
|--|----------------|
| FW02817 <sup>a b</sup> Windshield (Solar) .....  | 36.0x59.2      |
| FD23513-14 Door F/R-L (Solar) .....  | 21.0x41.0      |
| FQ23515-16 <sup>c</sup> Quarter R-L (Solar) .....  | 13.8x28.8      |
| FB23517 <sup>a</sup> Back Window (Ant)(Heated)(Solar) .....  | 41.0x47.0      |
| <sup>a</sup> Urethane,Dam,Primer - 2 Tubes<br><sup>b</sup> Fast-Cure Urethane/Dam/Primer - Quantity 2<br><sup>c</sup> Urethane,Dam,Primer - 1 Tube |                |

**Accord 2 Door Coupe..... 2006-2007**

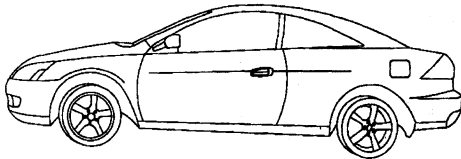

|  |           |
|--|-----------|
| FW02387 <sup>a b</sup> Windshield (Solar) (W/Third Visor Frit, W/Sunroof) ..   | 39.5x57.5 |
| FW02358 <sup>a b</sup> Windshield (Solar) (W/Third Visor Frit) .....   | 39.5x57.5 |
| FD21826-27 Door F/R-L (Solar) .....  | 17.0x40.0 |
| FQ21828-29 <sup>c</sup> Quarter R-L (Encap)(Solar) .....   | 14.4x32.0 |
| FB21830 <sup>a</sup> Back Window (Ant)(Heated)(Solar) .....  | 38.0x48.3 |
| <sup>a</sup> Urethane,Dam,Primer - 2 Tubes<br><sup>b</sup> Fast-Cure Urethane/Dam/Primer - Quantity 2<br><sup>c</sup> Urethane,Dam,Primer - 1 Tube |           |

**Accord 4 Door Sedan..... 2008-2011**



|   |           |
|---|-----------|
| FW02816 <sup>a b</sup> Windshield (Solar) (Electrochromic Mirror) .....                               | 37.8x59.2 |
| FW02815 <sup>a b</sup> Windshield (Solar) .....   | 37.8x59.2 |
| FW02814 <sup>a b</sup> Windshield (Solar) (W/Third Visor Frit) .....                                  | 37.8x59.2 |
| FD23508-09 Door F/R-L (Solar) .....   | 20.3x36.5 |
| FD23510-11 Door R/R-L (Solar) .....   | 18.0x26.5 |
| FV23539-40 Vent R/R-L (Solar) .....   | 12.5x13.3 |
| FB23512 <sup>a</sup> Back Window (Ant)(Heated)(Solar) .....   | 34.0x49.1 |
| <sup>a</sup> Urethane,Dam,Primer - 2 Tubes<br><sup>b</sup> Fast-Cure Urethane/Dam/Primer - Quantity 2 |           |

**Accord 4 Door Sedan..... 2006-2007**

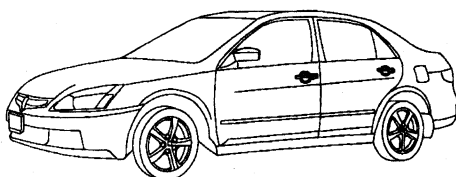

|   |           |
|---|-----------|
| FW02351 <sup>a b</sup> Windshield (Solar) .....                 | 40.0x58.3 |
| FD21806-07 Door F/R-L (Solar) .....                             | 20.5x38.3 |
| FD21808-09 Door R/R-L (Solar) .....                             | 18.7x27.8 |
| FV21810-11 Vent R/R-L (Solar) .....                             | 10.5x12.0 |
| FB23477 <sup>c</sup> Back Window (Heated)(Solar) (Hybrid) ..... | 27.8x52.0 |
| FB21812 <sup>c</sup> Back Window (Ant)(Heated)(Solar) .....     | 27.8x52.0 |

| <i>Accord</i>   | <i>(cont.)</i> |
|---|----------------|
| <sup>a</sup> Urethane,Dam,Primer - 2 Tubes<br><sup>b</sup> Fast-Cure Urethane/Dam/Primer - Quantity 2<br><sup>c</sup> Urethane,Dam,Primer - 1.5 Tubes |                |

**CR-V 4 Door Utility..... 2007-2011**

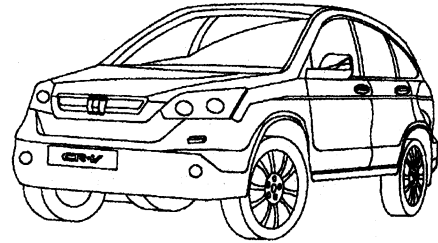

|  |           |
|--|-----------|
| FW02707 <sup>a b</sup> Windshield (Solar) (W/Third Visor Frit) .....   | 40.0x58.5 |
| FD23271-72 Door F/R-L (Solar) .....  | 23.0x37.3 |
| FD23273-74 Door R/R-L (Solar) .....  | 20.5x29.0 |
| FQ23275-76 <sup>d</sup> Quarter R-L (Solar) .....  | 15.0x25.0 |
| FB23277 <sup>c</sup> Back Window (Heated)(2 Holes)(Solar) .....  | 22.3x50.0 |
| <sup>a</sup> Urethane,Dam,Primer - 2 Tubes<br><sup>b</sup> Fast-Cure Urethane/Dam/Primer - Quantity 2<br><sup>c</sup> Urethane,Dam,Primer - 1.5 Tubes<br><sup>d</sup> Urethane,Dam,Primer - 1 Tube |           |

**CR-V 4 Door Utility..... 2006**

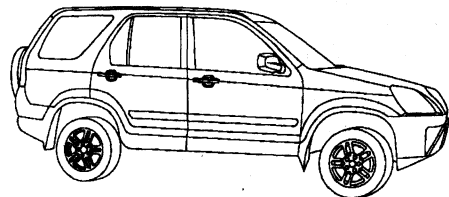

|  |           |
|--|-----------|
| FW02529 <sup>a b c</sup> Windshield (Solar) (W/Third Visor Frit) .....   | 34.2x60.2 |
| FD21571-72 Door F/R-L (Solar) .....  | 21.0x36.6 |
| FD21573-74 Door R/R-L (Solar) .....  | 21.3x21.9 |
| FQ21577-78 <sup>d</sup> Quarter R-L (Encap)(Solar) .....   | 17.8x29.6 |
| FV21575-76 Vent R/R-L (Solar) .....  | 6.8x18.0  |
| FB21579 Back Window (Heated)(6 Holes)(Solar) .....   | 19.4x49.5 |
| <sup>a</sup> Small GM-Type Mirror Button<br><sup>b</sup> Urethane,Dam,Primer - 2 Tubes<br><sup>c</sup> Fast-Cure Urethane/Dam/Primer - Quantity 2<br><sup>d</sup> Urethane,Dam,Primer - 1 Tube |           |

**CR-Z 2 Door Coupe..... 2011**

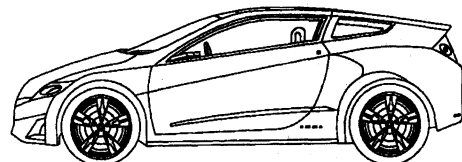

|  |  |
|--|--|
| FW03235 <sup>a b</sup> Windshield (Solar) (W/Third Visor Frit) ..... |  |
| FD24657-58 Door F/R-L (Solar) .....                                  |  |
| FQ24659-60 <sup>c</sup> Quarter R-L (Solar) .....                    |  |
| FB24663 <sup>c</sup> Back Window Lower (Heated)(Solar) .....         |  |

**CR-Z (cont.)**

|                            |   |                  |
|----------------------------|---|------------------|
| <b>FB24662<sup>c</sup></b> | Back Window Upper (Ant)(Heated)(1 Holes)(Solar) (W/Wiper) ..... | <b>32.0x36.5</b> |
| <b>FB24661<sup>c</sup></b> | Back Window Upper (Ant)(Heated)(Solar) .....                    | <b>32.0x36.5</b> |
| <sup>a</sup>               | Urethane,Dam,Primer - 2 Tubes                                   |                  |
| <sup>b</sup>               | Fast-Cure Urethane/Dam/Primer - Quantity 2                      |                  |
| <sup>c</sup>               | Urethane,Dam,Primer - 1.5 Tubes                                 |                  |

**City 4 Door Sedan (MEXICO Only)..... 2010-2011**

|                              |  |  |
|------------------------------|--|--|
| <b>FW03178<sup>a b</sup></b> | Windshield (Mexico Only) .....             |  |
| <b>FD24514-15</b>            | Door F/R-L (Mexico Only) .....             |  |
| <b>FD24516-17</b>            | Door R/R-L (Mexico Only) .....             |  |
| <b>FV24518-19</b>            | Vent R/R-L (Mexico Only) .....             |  |
| <b>FB24520<sup>c</sup></b>   | Back Window (Heated) (Mexico Only) .....   |  |
| <sup>a</sup>                 | Urethane,Dam,Primer - 2 Tubes              |  |
| <sup>b</sup>                 | Fast-Cure Urethane/Dam/Primer - Quantity 2 |  |
| <sup>c</sup>                 | Urethane,Dam,Primer - 1.5 Tubes            |  |

**Civic 2 Door Coupe..... 2006-2011**

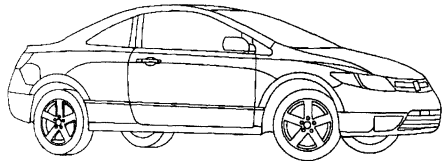

|                               |   |                  |
|-------------------------------|---|------------------|
| <b>FW02583<sup>a b</sup></b>  | Windshield (Solar) (W/Third Visor Frit) ..... | <b>45.3x54.3</b> |
| <b>FD22688-89</b>             | Door F/R-L (Solar) .....                      | <b>18.0x46.0</b> |
| <b>FQ22690-91<sup>c</sup></b> | Quarter R-L (Encap)(Solar) .....              | <b>13.0x23.3</b> |
| <b>FB22692<sup>a</sup></b>    | Back Window (Ant)(Heated)(Solar) .....        | <b>32.8x50.5</b> |
| <sup>a</sup>                  | Urethane,Dam,Primer - 2 Tubes                 |                  |
| <sup>b</sup>                  | Fast-Cure Urethane/Dam/Primer - Quantity 2    |                  |
| <sup>c</sup>                  | Urethane,Dam,Primer - 1 Tube                  |                  |

**Civic HYBRID 4 Door Sedan..... 2006-2011**  
**Civic 4 Door Sedan..... 2006-2011**

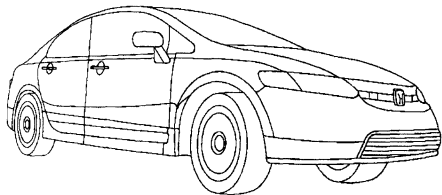

|                               |   |                  |
|-------------------------------|---|------------------|
| <b>FW02584<sup>a b</sup></b>  | Windshield (Solar) (W/Third Visor Frit) ..... | <b>43.8x54.0</b> |
| <b>FD22693-94</b>             | Door F/R-L (Solar) .....                      | <b>16.9x42.6</b> |
| <b>FD22695-96</b>             | Door R/R-L (Solar) .....                      | <b>18.0x27.5</b> |
| <b>FV22855-56<sup>d</sup></b> | Vent F/R-L (Solar) .....                      | <b>7.5x10.0</b>  |
| <b>FV22697-98</b>             | Vent R/R-L (Solar) .....                      | <b>7.0x10.0</b>  |
| <b>FB22699<sup>c</sup></b>    | Back Window (Ant)(Heated)(Solar) .....        | <b>30.0x48.5</b> |
| <sup>a</sup>                  | Urethane,Dam,Primer - 2 Tubes                 |                  |
| <sup>b</sup>                  | Fast-Cure Urethane/Dam/Primer - Quantity 2    |                  |
| <sup>c</sup>                  | Urethane,Dam,Primer - 1.5 Tubes               |                  |
| <sup>d</sup>                  | Urethane,Dam,Primer - 1 Tube                  |                  |

**Crosstour 4 Door Utility..... 2010-2011**

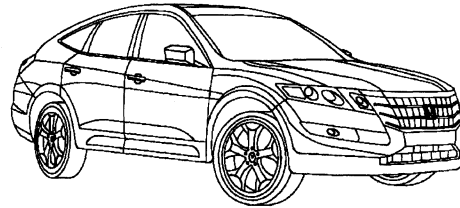

|                               |  |                  |
|-------------------------------|--|------------------|
| <b>FW03161<sup>a b</sup></b>  | Windshield (Solar) (Electrochromic Mirror) ..... | <b>36.5x58.0</b> |
| <b>FW03160<sup>a b</sup></b>  | Windshield (Solar) .....                         | <b>36.5x58.0</b> |
| <b>FD24447-48</b>             | Door F/R-L (Solar) .....                         | <b>23.0x34.0</b> |
| <b>FD24449-50</b>             | Door R/R-L (Solar) .....                         | <b>19.0x27.0</b> |
| <b>FQ24451-52<sup>d</sup></b> | Quarter R-L (Encap)(Solar) .....                 | <b>12.0x22.5</b> |
| <b>FB24454<sup>d</sup></b>    | Back Window Lower (Heated)(Solar) .....          | <b>7.5x41.5</b>  |
| <b>FB24453<sup>c</sup></b>    | Back Window Upper (Heated)(1 Holes)(Solar) ..... | <b>33.0x42.3</b> |
| <sup>a</sup>                  | Urethane,Dam,Primer - 2 Tubes                    |                  |
| <sup>b</sup>                  | Fast-Cure Urethane/Dam/Primer - Quantity 2       |                  |
| <sup>c</sup>                  | Urethane,Dam,Primer - 1.5 Tubes                  |                  |
| <sup>d</sup>                  | Urethane,Dam,Primer - 1 Tube                     |                  |

**Element 4 Door Utility..... 2006-2011**

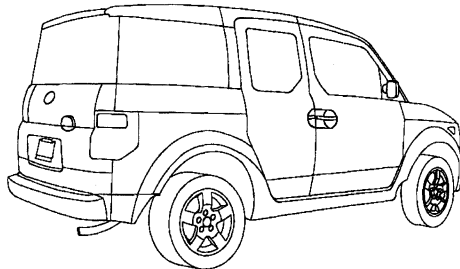

|                               |  |                  |
|-------------------------------|--|------------------|
| <b>FW02380<sup>a b</sup></b>  | Windshield .....                           | <b>28.6x59.7</b> |
| <b>FD21901-02</b>             | Door F/R-L .....                           | <b>20.4x34.2</b> |
| <b>FD21903-04</b>             | Door R/R-L (3 Holes) .....                 | <b>17.2x19.8</b> |
| <b>FQ21905-06<sup>c</sup></b> | Quarter R-L .....                          | <b>18.0x38.6</b> |
| <b>FB21907<sup>c</sup></b>    | Back Window (Heated)(1 Holes) .....        | <b>17.3x49.8</b> |
| <sup>a</sup>                  | Urethane,Dam,Primer - 2 Tubes              |                  |
| <sup>b</sup>                  | Fast-Cure Urethane/Dam/Primer - Quantity 2 |                  |
| <sup>c</sup>                  | Urethane,Dam,Primer - 1.5 Tubes            |                  |

**Fit 4 Door Hatchback..... 2009-2011**

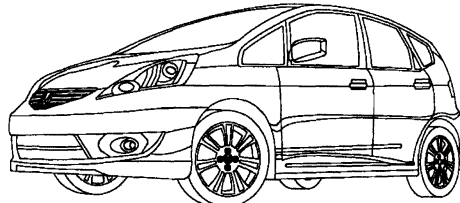

|                               |  |                  |
|-------------------------------|--|------------------|
| <b>FW03013<sup>a b</sup></b>  | Windshield (W/Third Visor Frit) .....      | <b>44.0x55.0</b> |
| <b>FD24062-63</b>             | Door F/R-L .....                           | <b>20.0x34.0</b> |
| <b>FD24064-65</b>             | Door R/R-L .....                           | <b>20.0x25.0</b> |
| <b>FQ24066-67<sup>d</sup></b> | Quarter R-L .....                          | <b>16.0x18.0</b> |
| <b>FV24060-61<sup>d</sup></b> | Vent F/R-L .....                           | <b>15.0x16.0</b> |
| <b>FB24068<sup>c</sup></b>    | Back Window (Heated) .....                 | <b>18.0x53.0</b> |
| <sup>a</sup>                  | Urethane,Dam,Primer - 2 Tubes              |                  |
| <sup>b</sup>                  | Fast-Cure Urethane/Dam/Primer - Quantity 2 |                  |
| <sup>c</sup>                  | Urethane,Dam,Primer - 1.5 Tubes            |                  |
| <sup>d</sup>                  | Urethane,Dam,Primer - 1 Tube               |                  |

**Fit 4 Door Hatchback..... 2006-2008**

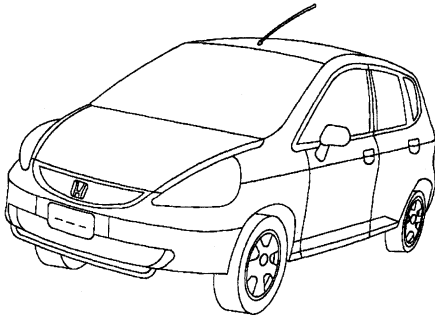

|  |                  |
|--|------------------|
| <b>FW02631<sup>a b</sup></b> Windshield (W/Third Visor Frit) ..... | <b>36.0x53.0</b> |
| <b>FD22962-63</b> Door F/R-L .....                                 | <b>20.8x37.5</b> |
| <b>FD22964-65</b> Door R/R-L .....                                 | <b>19.5x26.3</b> |
| <b>FQ22966-67<sup>d</sup></b> Quarter R-L .....                    | <b>14.5x16.0</b> |
| <b>FV22960-61<sup>d</sup></b> Vent F/R-L (Encap) .....             | <b>10.5x11.0</b> |
| <b>FB22968<sup>c</sup></b> Back Window (Heated) .....              | <b>18.5x52.0</b> |
| <sup>a</sup> Urethane,Dam,Primer - 2 Tubes                         |                  |
| <sup>b</sup> Fast-Cure Urethane/Dam/Primer - Quantity 2            |                  |
| <sup>c</sup> Urethane,Dam,Primer - 1.5 Tubes                       |                  |
| <sup>d</sup> Urethane,Dam,Primer - 1 Tube                          |                  |

**Insight 2 Door Hatchback..... 2006**

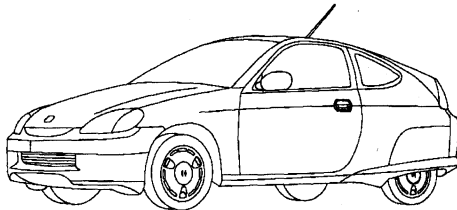

|  |                  |
|--|------------------|
| <b>FW02171<sup>a b</sup></b> Windshield (Solar) .....        | <b>35.0x58.0</b> |
| <b>FD20962-63</b> Door F/R-L (Solar) .....                   | <b>17.0x35.5</b> |
| <b>FQ20964-65<sup>d</sup></b> Quarter R-L (Solar) .....      | <b>15.5x23.0</b> |
| <b>FB20966<sup>c</sup></b> Back Window (Heated)(Solar) ..... | <b>38.0x42.0</b> |
| <sup>a</sup> Urethane,Dam,Primer - 2 Tubes                   |                  |
| <sup>b</sup> Fast-Cure Urethane/Dam/Primer - Quantity 2      |                  |
| <sup>c</sup> Urethane,Dam,Primer - 1.5 Tubes                 |                  |
| <sup>d</sup> Urethane,Dam,Primer - 1 Tube                    |                  |

**Insight 4 Door Hatchback..... 2010-2011**

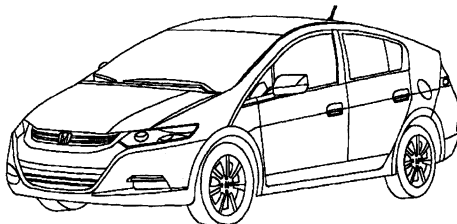

|   |                  |
|---|------------------|
| <b>FW03254<sup>a c d</sup></b> Windshield (Solar) (W/Third Visor Frit, Aftermarket) .....         | <b>39.0x55.0</b> |
| <b>FW03066<sup>b c d</sup></b> Windshield (Solar) (W/Third Visor Frit, Acoustic Interlayer) ..... | <b>39.0x55.0</b> |
| <b>FD24208-09</b> Door F/R-L (Solar) .....  | <b>18.0x32.0</b> |
| <b>FD24210-11</b> Door R/R-L (Solar) .....  | <b>18.0x24.0</b> |
| <b>FV24206-07</b> Vent F/R-L (Encap)(Solar) .....   | <b>7.0x10.0</b>  |
| <b>FV24212-13</b> Vent R/R-L (Encap)(Solar) .....   | <b>9.0x10.0</b>  |
| <b>FB24215<sup>f</sup></b> Back Window Lower (Heated)(Solar) .....                                | <b>7.0x42.0</b>  |

**Insight (cont.)**

|   |                  |
|---|------------------|
| <b>FB24214<sup>e</sup></b> Back Window Upper (Ant)(Heated)(1 Holes)(Solar) .. | <b>30.0x43.0</b> |
| <sup>a</sup> Not On Production Vehicles                                       |                  |
| <sup>b</sup> On Production Vehicles   |                  |
| <sup>c</sup> Urethane,Dam,Primer - 2 Tubes                                    |                  |
| <sup>d</sup> Fast-Cure Urethane/Dam/Primer - Quantity 2                       |                  |
| <sup>e</sup> Urethane,Dam,Primer - 1.5 Tubes                                  |                  |
| <sup>f</sup> Urethane,Dam,Primer - 1 Tube                                     |                  |

**Odyssey Mini Van ..... 2011**

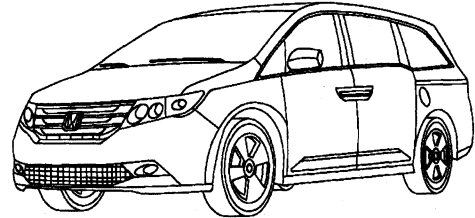

|  |                  |
|--|------------------|
| <b>FW03284<sup>a c d</sup></b> Windshield (Solar) (Electrochromic Mirror, W/Third Visor Frit, Acoustic Interlayer) ..... | <b>44.8x65.7</b> |
| <b>FW03283<sup>a c d</sup></b> Windshield (Solar) (Electrochromic Mirror, W/Third Visor Frit) .....                      | <b>44.8x65.7</b> |
| <b>FW03282<sup>a c d</sup></b> Windshield (Solar) (W/Third Visor Frit) .....   | <b>44.8x65.7</b> |
| <b>FD24728-29</b> Door F/R-L (Solar) .....   |                  |
| <b>FD24730-31</b> Door R/R-L (Solar) (Sliding Cargo Door) .....  |                  |
| <b>FQ24894<sup>b</sup></b> Quarter L (Ant)(Encap)(Solar) (W/Navigation) .....  |                  |
| <b>FQ24733<sup>b</sup></b> Quarter L (Encap)(Solar) .....  |                  |
| <b>FQ24732<sup>b</sup></b> Quarter R (Ant)(Encap)(Solar) .....   |                  |
| <b>FV24726-27<sup>b</sup></b> Vent F/R-L (Encap)(Solar) .....  |                  |
| <b>FB24734<sup>b</sup></b> Back Window (Heated)(1 Holes)(Solar) (W/Wiper) ...  |                  |
| <sup>a</sup> May Require Two Person Installation   |                  |
| <sup>b</sup> Urethane,Dam,Primer - 1.5 Tubes   |                  |
| <sup>c</sup> Urethane,Dam,Primer - 2.5 Tubes   |                  |
| <sup>d</sup> Fast-Cure Urethane/Dam/Primer - Quantity 2.5  |                  |

**Odyssey Mini Van ..... 2006-2010**

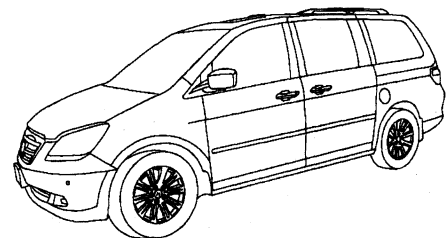

|   |                  |
|---|------------------|
| <b>FW02502<sup>a e f</sup></b> Windshield (Solar) (Electrochromic Mirror) ..... | <b>42.5x66.5</b> |
| <b>FW02501<sup>a e f</sup></b> Windshield (Solar) .....                         | <b>42.5x66.5</b> |
| <b>FD22405-06</b> Door F/R-L (Solar) .....                                      | <b>27.0x37.5</b> |
| <b>FD22407-08<sup>d</sup></b> Door R/R-L (Solar) (Sliding Cargo Door) .....     | <b>20.9x30.3</b> |
| <b>FQ22409-10<sup>c</sup></b> Quarter R-L (Solar) .....                         | <b>20.1x37.2</b> |
| <b>FV22439-40</b> Vent R/R-L (Solar) (Stationary, Sliding Cargo Door) ..        | <b>8.0x20.0</b>  |
| <b>FB22411<sup>b</sup></b> Back Window (Heated)(1 Holes)(Solar) .....           | <b>23.0x59.5</b> |
| <sup>a</sup> May Require Two Person Installation                                |                  |
| <sup>b</sup> Urethane,Dam,Primer - 2 Tubes                                      |                  |
| <sup>c</sup> Urethane,Dam,Primer - 1.5 Tubes                                    |                  |
| <sup>d</sup> Urethane,Dam,Primer - 1 Tube                                       |                  |
| <sup>e</sup> Urethane,Dam,Primer - 2.5 Tubes                                    |                  |
| <sup>f</sup> Fast-Cure Urethane/Dam/Primer - Quantity 2.5                       |                  |

**Pilot 4 Door Utility ..... 2009-2011**

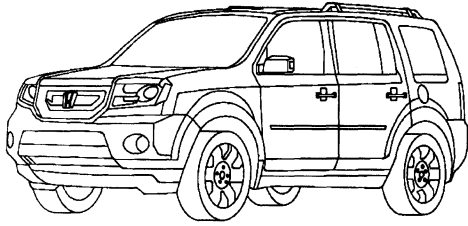

|  |                  |
|--|------------------|
| <b>FW03262<sup>a c d</sup></b> Windshield (Solar) (Electrochromic Mirror, Aftermarket) .....         | <b>37.1x63.9</b> |
| <b>FW03253<sup>b c d</sup></b> Windshield (Solar) (Acoustic Interlayer) (11) .....                   | <b>37.1x63.9</b> |
| <b>FW02926<sup>b c d</sup></b> Windshield (Solar) (Electrochromic Mirror, Acoustic Interlayer) ..... | <b>37.1x63.9</b> |
| <b>FW02925<sup>b c d</sup></b> Windshield (Solar) .....  | <b>37.1x63.9</b> |
| <b>FD23786-87</b> Door F/R-L (Solar) .....   | <b>21.0x33.0</b> |
| <b>FD23788-89</b> Door R/R-L (Solar) .....   | <b>21.0x24.0</b> |
| <b>FQ23793<sup>f</sup></b> Quarter L (Solar) .....   | <b>18.0x24.0</b> |
| <b>FQ23792<sup>f</sup></b> Quarter R (Ant)(Solar) .....  | <b>18.0x24.0</b> |
| <b>FV23790-91</b> Vent R/R-L (Solar) .....   | <b>7.0x18.0</b>  |
| <b>FB23794<sup>e</sup></b> Back Window (Heated)(Solar) .....   | <b>20.0x59.0</b> |

<sup>a</sup> Not On Production Vehicles  
<sup>b</sup> On Production Vehicles  
<sup>c</sup> Urethane,Dam,Primer - 2 Tubes  
<sup>d</sup> Fast-Cure Urethane/Dam/Primer - Quantity 2  
<sup>e</sup> Urethane,Dam,Primer - 1.5 Tubes  
<sup>f</sup> Urethane,Dam,Primer - 1 Tube

**Pilot 4 Door Utility ..... 2006-2008**

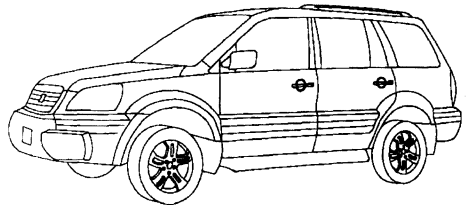

|   |                  |
|---|------------------|
| <b>FW02582<sup>a b</sup></b> Windshield (Solar) (Electrochromic Mirror) ..... | <b>39.0x62.5</b> |
| <b>FW02314<sup>a b</sup></b> Windshield (Solar) .....                         | <b>39.0x62.5</b> |
| <b>FD21708-09</b> Door F/R-L (Solar) .....                                    | <b>22.0x38.0</b> |
| <b>FD21710-11</b> Door R/R-L (Solar) .....                                    | <b>23.6x25.8</b> |
| <b>FQ21715<sup>d</sup></b> Quarter L (Ant)(Solar) .....                       | <b>19.5x30.0</b> |
| <b>FQ21714<sup>d</sup></b> Quarter R (Solar) .....                            | <b>19.5x30.0</b> |
| <b>FV21712-13</b> Vent R/R-L (Solar) .....                                    | <b>7.7x18.5</b>  |
| <b>FB21716<sup>c</sup></b> Back Window (Heated)(1 Holes)(Solar) (W/Wiper) ... | <b>20.8x53.9</b> |

<sup>a</sup> Urethane,Dam,Primer - 2 Tubes  
<sup>b</sup> Fast-Cure Urethane/Dam/Primer - Quantity 2  
<sup>c</sup> Urethane,Dam,Primer - 1.5 Tubes  
<sup>d</sup> Urethane,Dam,Primer - 1 Tube

**Ridgeline 4 Door Crew Cab ..... 2006-2011**

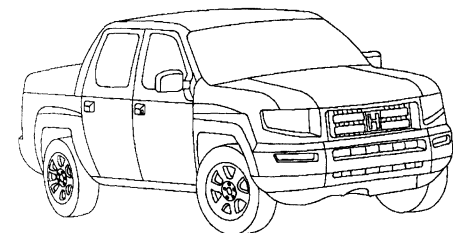

**Ridgeline (cont.)**

|  |                  |
|--|------------------|
| <b>FW02538<sup>b c d</sup></b> Windshield (Heated)(Solar) (Electrochromic Mirror, W/Sunroof, Heated Wiper Park Area) ..... | <b>36.6x66.1</b> |
| <b>FW02537<sup>b c d</sup></b> Windshield (Heated)(Solar) (W/Sunroof, Heated Wiper Park Area) .....                        | <b>36.6x66.1</b> |
| <b>FW02536<sup>b c d</sup></b> Windshield (Heated)(Solar) (Electrochromic Mirror, Heated Wiper Park Area) .....            | <b>36.6x66.1</b> |
| <b>FW02535<sup>b c d</sup></b> Windshield (Heated)(Solar) (Heated Wiper Park Area) .....                                   | <b>36.6x66.1</b> |
| <b>FD22564-65</b> Door F/R-L (Solar) .....   | <b>23.5x31.5</b> |
| <b>FD22566-67</b> Door R/R-L (Solar) .....   | <b>21.5x29.0</b> |
| <b>FB22675</b> Back Window C (Slider)(Solar) .....   | <b>13.8x15.8</b> |
| <b>FB22568<sup>a e</sup></b> Back Window (Slider)(Solar) .....   | <b>12.0x51.0</b> |

<sup>a</sup> Does Not Include Center Slider  
<sup>b</sup> May Require Two Person Installation  
<sup>c</sup> Urethane,Dam,Primer - 2 Tubes  
<sup>d</sup> Fast-Cure Urethane/Dam/Primer - Quantity 2  
<sup>e</sup> Urethane,Dam,Primer - 1.5 Tubes

**S2000 2 Door Convertible ..... 2006-2009**

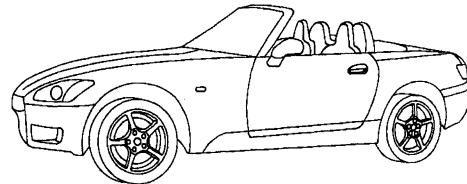

|  |                  |
|--|------------------|
| <b>FW02161<sup>a b</sup></b> Windshield (Solar) .....                                | <b>25.0x56.0</b> |
| <b>FD20884-85</b> Door F/R-L (6 Holes)(Solar) .....                                  | <b>16.0x28.0</b> |
| <b>FB22722</b> Back Window (Solar) (Glass Only, Aftermarket, Soft Top) .....         | <b>11.5x36.8</b> |
| <b>FB22333</b> Back Window (Heated)(Solar) (Glass Only, Aftermarket, Soft Top) ..... | <b>11.5x36.8</b> |

<sup>a</sup> Urethane,Dam,Primer - 1.5 Tubes  
<sup>b</sup> Fast-Cure Urethane/Dam/Primer - Quantity 1.5

**Hummer H2 SUT 4 Door Crew Cab ..... 2006-2010**

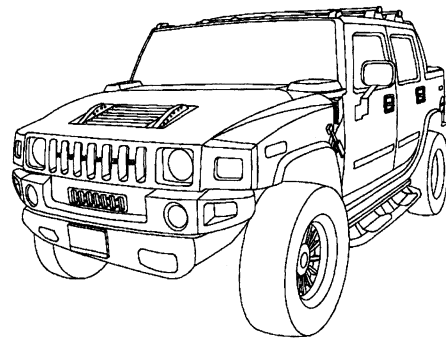

|   |                  |
|---|------------------|
| <b>DW01486<sup>a b c</sup></b> Windshield (Solar) .....             | <b>24.1x76.1</b> |
| <b>DD10175-76</b> Door F/R-L (Solar) .....                          | <b>17.0x32.0</b> |
| <b>DD10177-78</b> Door R/R-L (Solar) .....                          | <b>24.0x29.2</b> |
| <b>DR10865</b> Roof (Solar) .....                                   | <b>18.9x36.8</b> |
| <b>DB10853<sup>d</sup></b> Back Window C (Heated)(Solar) .....      | <b>17.0x57.0</b> |
| <b>DB11390<sup>d</sup></b> Back Window L/Outer (Encap)(Solar) ..... | <b>17.0x57.0</b> |
| <b>DB11389<sup>d</sup></b> Back Window R/Outer (Encap)(Solar) ..... | <b>17.0x57.0</b> |

<sup>a</sup> May Require Two Person Installation  
<sup>b</sup> Urethane,Dam,Primer - 2 Tubes  
<sup>c</sup> Fast-Cure Urethane/Dam/Primer - Quantity 2  
<sup>d</sup> Urethane,Dam,Primer - 1.5 Tubes



**H2 4 Door Utility ..... 2006-2010**

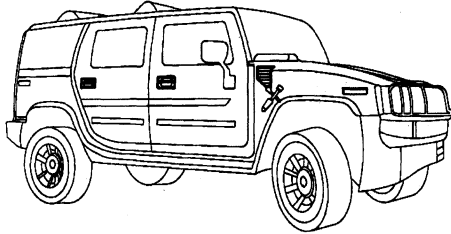

|  |           |
|--|-----------|
| DW01486 <sup>a b c</sup> Windshield (Solar) .....                | 24.1x76.1 |
| DD10175-76 Door F/R-L (Solar) .....                              | 17.0x32.0 |
| DD10177-78 Door R/R-L (Solar) .....                              | 24.0x29.2 |
| DR10865 Roof (Solar) .....                                       | 18.9x36.8 |
| DQ11578-79 <sup>e</sup> Quarter R-L (Encap)(Solar) (08-10) ..... | 14.0x35.0 |
| DQ10179-80 <sup>e</sup> Quarter R-L (Encap)(Solar) (06-07) ..... | 14.0x35.0 |
| DB10181 <sup>d</sup> Back Window (Heated)(Solar) .....           | 17.0x57.0 |

<sup>a</sup> May Require Two Person Installation  
<sup>b</sup> Urethane,Dam,Primer - 2 Tubes  
<sup>c</sup> Fast-Cure Urethane/Dam/Primer - Quantity 2  
<sup>d</sup> Urethane,Dam,Primer - 1.5 Tubes  
<sup>e</sup> Urethane,Dam,Primer - 1 Tube

**H3 4 Door Utility ..... 2006-2010**

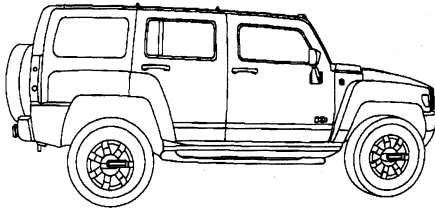

|   |           |
|---|-----------|
| DW01764 <sup>a b</sup> Windshield (Solar) (07-10) ..... | 25.0x62.0 |
| DW01626 <sup>a b</sup> Windshield (Solar) (06) .....    | 25.0x62.0 |
| DD10955-56 Door F/R-L (Solar) .....                     | 15.0x31.0 |
| DD10957-58 Door R/R-L (Solar) .....                     | 15.0x20.5 |
| DR11366 Roof (Solar) .....                              |           |
| DQ10961-62 <sup>d</sup> Quarter R-L (Solar) .....       | 14.5x27.0 |
| DV10959-60 Vent R/R-L (Solar) .....                     | 5.0x13.0  |
| DB10963 <sup>c</sup> Back Window (Heated)(Solar) .....  | 15.0x53.5 |

<sup>a</sup> Urethane,Dam,Primer - 2 Tubes  
<sup>b</sup> Fast-Cure Urethane/Dam/Primer - Quantity 2  
<sup>c</sup> Urethane,Dam,Primer - 1.5 Tubes  
<sup>d</sup> Urethane,Dam,Primer - 1 Tube

**H3T 4 Door Crew Cab ..... 2009-2010**

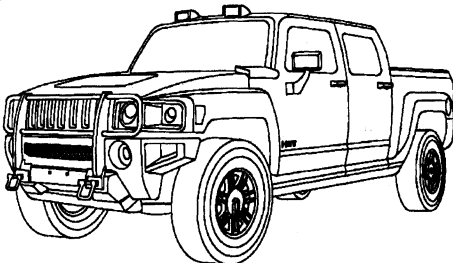

|  |           |
|--|-----------|
| DW01764 <sup>a b</sup> Windshield (Solar) .....        | 25.0x62.0 |
| DD10955-56 Door F/R-L (Solar) .....                    | 15.0x31.0 |
| DD11734-35 Door R/R-L (Solar) .....                    | 15.0x31.0 |
| DB11736 <sup>c</sup> Back Window (Heated)(Solar) ..... | 13.5x52.0 |

**H3T (cont.)**

- <sup>a</sup> Urethane,Dam,Primer - 2 Tubes
- <sup>b</sup> Fast-Cure Urethane/Dam/Primer - Quantity 2
- <sup>c</sup> Urethane,Dam,Primer - 1.5 Tubes

**Accent 2 Door Hatchback ..... 2007-2011**

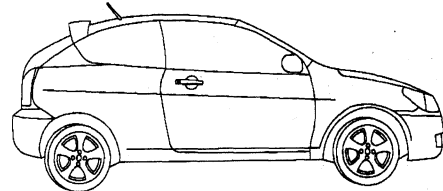

|  |           |
|--|-----------|
| FW02716 <sup>a b</sup> Windshield (Solar) .....                    | 32.9x55.5 |
| FW02632 <sup>a b</sup> Windshield .....                            | 32.9x55.5 |
| FD23211-12 Door F/R-L (2 Holes) .....                              | 24.3x44.0 |
| FQ23213-14 <sup>d</sup> Quarter R-L (Encap) .....                  | 16.8x31.8 |
| FB23216 <sup>c</sup> Back Window (Heated)(1 Holes) (W/Wiper) ..... | 20.5x41.0 |
| FB23215 <sup>c</sup> Back Window (Heated) .....                    | 20.5x41.0 |

<sup>a</sup> Urethane,Dam,Primer - 2 Tubes  
<sup>b</sup> Fast-Cure Urethane/Dam/Primer - Quantity 2  
<sup>c</sup> Urethane,Dam,Primer - 1.5 Tubes  
<sup>d</sup> Urethane,Dam,Primer - 1 Tube

**Accent 2 Door Hatchback ..... 2006**

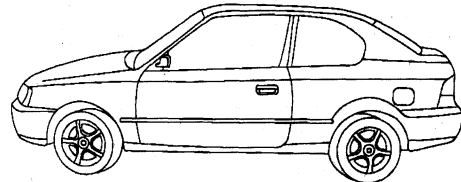

|  |           |
|--|-----------|
| FW02162 <sup>a b</sup> Windshield .....                            | 32.9x55.5 |
| FD21079-80 Door F/R-L .....  | 23.5x43.0 |
| FQ20909-10 <sup>d</sup> Quarter R-L (Encap) .....                  | 15.5x24.0 |
| FB22188 <sup>c</sup> Back Window (Heated)(1 Holes) (W/Wiper) ..... | 27.8x50.3 |
| FB22187 <sup>c</sup> Back Window (Heated) (W/O Wiper) .....        | 27.8x50.3 |

<sup>a</sup> Urethane,Dam,Primer - 2 Tubes  
<sup>b</sup> Fast-Cure Urethane/Dam/Primer - Quantity 2  
<sup>c</sup> Urethane,Dam,Primer - 1.5 Tubes  
<sup>d</sup> Urethane,Dam,Primer - 1 Tube

**Accent 4 Door Hatchback ..... 2006 (CANADA Only)**

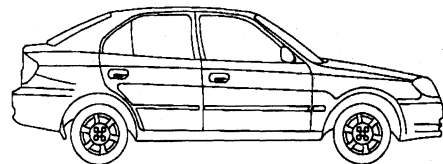

|   |           |
|---|-----------|
| FW02162 <sup>a b</sup> Windshield .....         | 32.9x55.5 |
| FD20907-08 Door F/R-L (2 Holes) .....           | 22.0x30.5 |
| FD20913-14 Door R/R-L (2 Holes) .....           | 22.0x25.0 |
| FV20915-16 Vent R/R-L .....                     | 11.0x13.5 |
| FB22586 <sup>c</sup> Back Window (Heated) ..... |           |

|   |                |
|---|----------------|
| <b>Accent</b>   | <b>(cont.)</b> |
| <sup>a</sup> Urethane,Dam,Primer - 2 Tubes<br><sup>b</sup> Fast-Cure Urethane/Dam/Primer - Quantity 2<br><sup>c</sup> Urethane,Dam,Primer - 1.5 Tubes |                |

|  |                |
|--|----------------|
| <b>Elantra</b>   | <b>(cont.)</b> |
| <sup>b</sup> Fast-Cure Urethane/Dam/Primer - Quantity 2<br><sup>c</sup> Urethane,Dam,Primer - 1.5 Tubes<br><sup>d</sup> Urethane,Dam,Primer - 1 Tube |                |

**Accent 4 Door Sedan ..... 2006-2011**

**Elantra 4 Door Sedan..... 2007-2011**

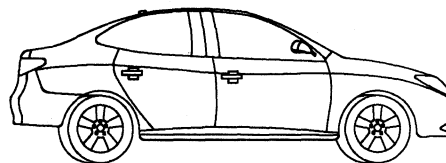
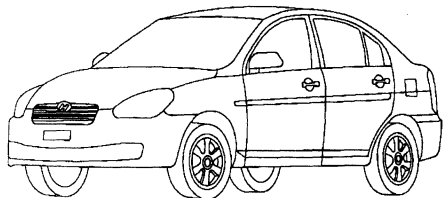

|                              |                            |                  |
|------------------------------|----------------------------|------------------|
| <b>FW02716<sup>a b</sup></b> | Windshield (Solar) .....   | <b>32.9x55.5</b> |
| <b>FW02632<sup>a b</sup></b> | Windshield .....           | <b>32.9x55.5</b> |
| <b>FD23033-34</b>            | Door F/R-L (2 Holes) ..... | <b>22.0x35.0</b> |
| <b>FD23035-36</b>            | Door R/R-L (2 Holes) ..... | <b>19.5x24.8</b> |
| <b>FV23037-38</b>            | Vent R/R-L .....           | <b>9.3x11.8</b>  |
| <b>FB23039<sup>c</sup></b>   | Back Window (Heated) ..... | <b>26.8x46.8</b> |

<sup>a</sup> Urethane,Dam,Primer - 2 Tubes  
<sup>b</sup> Fast-Cure Urethane/Dam/Primer - Quantity 2  
<sup>c</sup> Urethane,Dam,Primer - 1.5 Tubes

|                               |  |                  |
|-------------------------------|--|------------------|
| <b>FW02713<sup>a b</sup></b>  | Windshield (Solar) (Electrochromic Mirror) ..... | <b>38.0x58.0</b> |
| <b>FW02712<sup>a b</sup></b>  | Windshield (Solar) .....                         | <b>38.0x58.0</b> |
| <b>FW02711<sup>a b</sup></b>  | Windshield (Electrochromic Mirror) .....         | <b>38.0x58.0</b> |
| <b>FW02710<sup>a b</sup></b>  | Windshield .....                                 | <b>38.0x58.0</b> |
| <b>FD23290-91</b>             | Door F/R-L .....                                 | <b>21.5x36.3</b> |
| <b>FD23292-93</b>             | Door R/R-L .....                                 | <b>19.8x28.8</b> |
| <b>FQ23294-95<sup>d</sup></b> | Quarter R-L (Encap) .....                        | <b>11.0x12.0</b> |
| <b>FB23297<sup>c</sup></b>    | Back Window (Ant)(Heated) .....                  | <b>28.3x48.5</b> |
| <b>FB23296<sup>c</sup></b>    | Back Window (Heated)(Solar) .....                | <b>28.3x48.5</b> |

<sup>a</sup> Urethane,Dam,Primer - 2 Tubes  
<sup>b</sup> Fast-Cure Urethane/Dam/Primer - Quantity 2  
<sup>c</sup> Urethane,Dam,Primer - 1.5 Tubes  
<sup>d</sup> Urethane,Dam,Primer - 1 Tube

**Azera 4 Door Sedan ..... 2006-2011**

**Elantra 4 Door Sedan..... 2006**

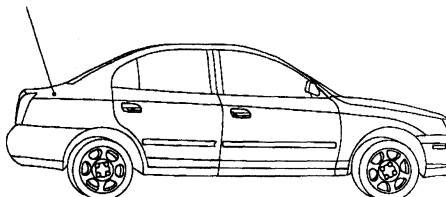
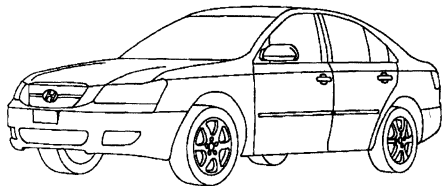

|                               |  |                  |
|-------------------------------|--|------------------|
| <b>FW02618<sup>a b</sup></b>  | Windshield (Heated)(Solar) (W/Third Visor Frit, Heated Wiper Park Area, Rain Sensor) ..... | <b>40.3x61.8</b> |
| <b>FW02617<sup>a b</sup></b>  | Windshield (Heated)(Solar) (W/Third Visor Frit, Heated Wiper Park Area) .....              | <b>40.3x61.8</b> |
| <b>FW02616<sup>a b</sup></b>  | Windshield (Solar) (W/Third Visor Frit, Rain Sensor) .....                                 | <b>40.3x61.8</b> |
| <b>FW02615<sup>a b</sup></b>  | Windshield (Solar) (W/Third Visor Frit) .....  | <b>40.3x61.8</b> |
| <b>FD22887-88</b>             | Door F/R-L (Solar) .....   | <b>22.0x35.5</b> |
| <b>FD22889-90</b>             | Door R/R-L (1 Holes)(Solar) .....  | <b>21.3x30.5</b> |
| <b>FQ22891-92<sup>c</sup></b> | Quarter R-L (Encap)(Solar) .....   | <b>12.0x13.0</b> |
| <b>FB22893<sup>a</sup></b>    | Back Window (Ant)(Heated)(Solar) .....   | <b>32.5x51.5</b> |

<sup>a</sup> Urethane,Dam,Primer - 2 Tubes  
<sup>b</sup> Fast-Cure Urethane/Dam/Primer - Quantity 2  
<sup>c</sup> Urethane,Dam,Primer - 1 Tube

|                              |                            |                  |
|------------------------------|----------------------------|------------------|
| <b>FW02228<sup>a b</sup></b> | Windshield .....           | <b>34.7x56.4</b> |
| <b>FD21230-31</b>            | Door F/R-L .....           | <b>20.0x32.0</b> |
| <b>FD21232-33</b>            | Door R/R-L .....           | <b>18.6x25.0</b> |
| <b>FV21234-35</b>            | Vent R/R-L .....           | <b>8.0x12.0</b>  |
| <b>FB21236<sup>c</sup></b>   | Back Window (Heated) ..... | <b>27.3x50.0</b> |

<sup>a</sup> Urethane,Dam,Primer - 2 Tubes  
<sup>b</sup> Fast-Cure Urethane/Dam/Primer - Quantity 2  
<sup>c</sup> Urethane,Dam,Primer - 1.5 Tubes

**Elantra 4 Door Hatchback..... 2006**

**Elantra 4 Door Station Wagon..... 2009-2011**

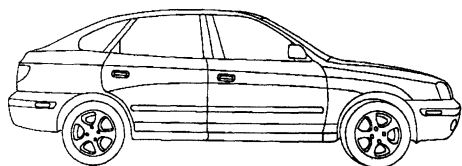

|                               |                            |                  |
|-------------------------------|----------------------------|------------------|
| <b>FW02228<sup>a b</sup></b>  | Windshield .....           | <b>34.7x56.4</b> |
| <b>FD21230-31</b>             | Door F/R-L .....           | <b>20.0x32.0</b> |
| <b>FD21452-53</b>             | Door R/R-L (2 Holes) ..... | <b>21.5x29.0</b> |
| <b>FQ21454-55<sup>d</sup></b> | Quarter R-L (Encap) .....  | <b>13.5x18.0</b> |
| <b>FB21456<sup>c</sup></b>    | Back Window (Heated) ..... | <b>35.0x45.5</b> |

<sup>a</sup> Urethane,Dam,Primer - 2 Tubes

|                                |   |                  |
|--------------------------------|---|------------------|
| <b>FW03084<sup>a b d</sup></b> | Windshield (Heated)(Solar) (Electrochromic Mirror, Heated Wiper Park Area, Rain Sensor) ..... | <b>40.0x57.0</b> |
| <b>FW03083<sup>a b</sup></b>   | Windshield (Heated)(Solar) (Electrochromic Mirror, Heated Wiper Park Area) .....              | <b>40.0x57.0</b> |

**Elantra (cont.)**

|                          |  |           |
|--------------------------|--|-----------|
| FW03082 <sup>a b d</sup> | Windshield (Solar) (Electrochromic Mirror, Rain Sensor)                          | 40.0x57.0 |
| FW03081 <sup>a b</sup>   | Windshield (Solar) (Electrochromic Mirror)                                       | 40.0x57.0 |
| FW03080 <sup>a b d</sup> | Windshield (Heated)(Solar) (Heated Wiper Park Area, Rain Sensor)                 | 40.0x57.0 |
| FW03079 <sup>a b</sup>   | Windshield (Heated)(Solar) (Heated Wiper Park Area)                              | 40.0x57.0 |
| FW03078 <sup>a b d</sup> | Windshield (Solar) (Rain Sensor)   | 40.0x57.0 |
| FW03077 <sup>a b</sup>   | Windshield (Solar)   | 40.0x57.0 |
| FW03076 <sup>a b d</sup> | Windshield (Heated) (Electrochromic Mirror, Heated Wiper Park Area, Rain Sensor) | 40.0x57.0 |
| FW03075 <sup>a b</sup>   | Windshield (Heated) (Electrochromic Mirror, Heated Wiper Park Area)              | 40.0x57.0 |
| FW03074 <sup>a b d</sup> | Windshield (Electrochromic Mirror, Rain Sensor)                                  | 40.0x57.0 |
| FW03073 <sup>a b</sup>   | Windshield (Electrochromic Mirror)   | 40.0x57.0 |
| FW03072 <sup>a b d</sup> | Windshield (Heated) (Heated Wiper Park Area, Rain Sensor)                        | 40.0x57.0 |
| FW03071 <sup>a b</sup>   | Windshield (Heated) (Heated Wiper Park Area)                                     | 40.0x57.0 |
| FW03070 <sup>a b d</sup> | Windshield (Rain Sensor)   | 40.0x57.0 |
| FW03069 <sup>a b</sup>   | Windshield   | 40.0x57.0 |
| FD24216-17               | Door F/R-L (Solar)   | 19.0x31.0 |
| FD24218-19               | Door R/R-L (Solar)   | 20.6x30.5 |
| FQ24220-21 <sup>c</sup>  | Quarter R-L (Solar)  | 15.5x20.0 |
| FB24222 <sup>c</sup>     | Back Window (Heated)(Solar)  | 19.5x49.0 |

<sup>a</sup> Urethane,Dam,Primer - 2 Tubes  
<sup>b</sup> Fast-Cure Urethane/Dam/Primer - Quantity 2  
<sup>c</sup> Urethane,Dam,Primer - 1.5 Tubes  
<sup>d</sup> Rain Sensor Kit  
<sup>e</sup> Urethane,Dam,Primer - 1 Tube

**Entourage Mini Van 2007-2011**

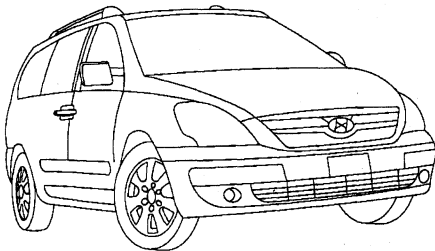

|                          |   |           |
|--------------------------|---|-----------|
| FW02642 <sup>a b c</sup> | Windshield (Heated)(Solar) (Electrochromic Mirror, Heated Wiper Park Area, Rain Sensor) | 42.0x65.0 |
| FW02641 <sup>a b c</sup> | Windshield (Heated)(Solar) (Heated Wiper Park Area, Rain Sensor)                        | 42.0x65.0 |
| FW02640 <sup>a b</sup>   | Windshield (Heated)(Solar) (Heated Wiper Park Area)                                     | 42.0x65.0 |
| FW02639 <sup>a b</sup>   | Windshield (Heated)(Solar) (Electrochromic Mirror, Heated Wiper Park Area)              | 42.0x65.0 |
| FW02638 <sup>a b</sup>   | Windshield (Heated) (Heated Wiper Park Area)  | 42.0x65.0 |
| FD23006-07               | Door F/R-L (Solar)  | 22.0x33.0 |
| FD23004-05               | Door F/R-L  | 22.0x33.0 |
| FD23008-09               | Door R/R-L (Solar) (Sliding Cargo Door)   | 23.3x33.0 |
| FQ23010-11               | Quarter R-L (Ant)(1 Holes)(Solar)   | 20.5x40.5 |
| FB23012 <sup>a</sup>     | Back Window (Heated)(1 Holes)(Solar) (W/Wiper)  | 23.8x57.8 |

<sup>a</sup> Urethane,Dam,Primer - 2 Tubes  
<sup>b</sup> Fast-Cure Urethane/Dam/Primer - Quantity 2  
<sup>c</sup> Rain Sensor Kit

**Genesis 2 Door Coupe 2010-2011**

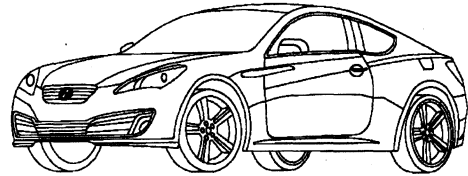

|                         |  |           |
|-------------------------|--|-----------|
| FW03144 <sup>a b</sup>  | Windshield (Heated) (Electrochromic Mirror, W/Third Visor Frit, Heated Wiper Park Area)        | 35.0x58.5 |
| FW03111 <sup>a b</sup>  | Windshield (Heated)(Solar) (Electrochromic Mirror, W/Third Visor Frit, Heated Wiper Park Area) | 35.0x58.5 |
| FW03110 <sup>a b</sup>  | Windshield (Solar) (Electrochromic Mirror, W/Third Visor Frit)                                 | 35.0x58.5 |
| FW03109 <sup>a b</sup>  | Windshield (Heated)(Solar) (W/Third Visor Frit, Heated Wiper Park Area)                        | 35.0x58.5 |
| FW03108 <sup>a b</sup>  | Windshield (Solar) (W/Third Visor Frit)  | 35.0x58.5 |
| FW03107 <sup>a b</sup>  | Windshield (Electrochromic Mirror, W/Third Visor Frit)   | 35.0x58.5 |
| FW03106 <sup>a b</sup>  | Windshield (Heated) (W/Third Visor Frit, Heated Wiper Park Area)                               | 35.0x58.5 |
| FW03105 <sup>a b</sup>  | Windshield (W/Third Visor Frit)  | 35.0x58.5 |
| FD24330-31              | Door F/R-L (Solar)   | 16.0x40.5 |
| FD24328-29              | Door F/R-L   | 16.0x40.5 |
| FQ24334-35 <sup>c</sup> | Quarter R-L (Encap)(Solar)   | 13.5x24.0 |
| FQ24332-33 <sup>c</sup> | Quarter R-L (Encap)  | 13.5x24.0 |
| FB24343 <sup>a</sup>    | Back Window (Ant)(Solar) (W/Spoiler)   | 39.5x45.5 |
| FB24342 <sup>a</sup>    | Back Window (Solar) (W/Spoiler)  | 39.5x45.5 |
| FB24341 <sup>a</sup>    | Back Window (Ant)(Solar)   | 39.5x45.5 |
| FB24340 <sup>a</sup>    | Back Window (Solar)  | 39.5x45.5 |
| FB24339 <sup>a</sup>    | Back Window (Ant) (W/Spoiler)  | 39.5x45.5 |
| FB24338 <sup>a</sup>    | Back Window (W/Spoiler)  | 39.5x45.5 |
| FB24337 <sup>a</sup>    | Back Window (Ant)  | 39.5x45.5 |
| FB24336 <sup>a</sup>    | Back Window  | 39.5x45.5 |

<sup>a</sup> Urethane,Dam,Primer - 2 Tubes  
<sup>b</sup> Fast-Cure Urethane/Dam/Primer - Quantity 2  
<sup>c</sup> Urethane,Dam,Primer - 1 Tube

**Genesis 4 Door Sedan 2009-2011**

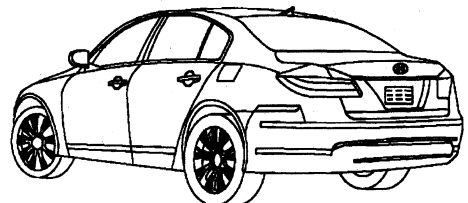

|                            |  |           |
|----------------------------|--|-----------|
| FW03267 <sup>a c d e</sup> | Windshield (Heated)(Solar) (W/Third Visor Frit, Aftermarket, Heated Wiper Park Area, Rain Sensor, Condensation Sensor)         | 34.0x56.0 |
| FW03266 <sup>a c d</sup>   | Windshield (Heated)(Solar) (W/Third Visor Frit, Aftermarket, Heated Wiper Park Area)   | 34.0x56.0 |
| FW02997 <sup>b c d</sup>   | Windshield (Heated)(Solar) (W/Third Visor Frit, Acoustic Interlayer, Heated Wiper Park Area)                                   | 34.0x56.0 |
| FW02997 <sup>b c d</sup>   | Windshield (Heated)(Solar) (W/Third Visor Frit, Acoustic Interlayer, Heated Wiper Park Area, Rain Sensor, Condensation Sensor) | 34.0x56.0 |
| FD23989-90                 | Door F/R-L (Solar) (Laminated, Acoustic Interlayer)  | 20.0x33.0 |
| FD24004-05                 | Door R/R-L (Solar) (Laminated)   | 20.0x28.0 |
| FD23991-92                 | Door R/R-L (Solar)   | 20.0x28.0 |
| FV24006-07                 | Vent R/R-L (Solar) (Laminated)   | 11.0x12.0 |
| FV23993-94                 | Vent R/R-L (Solar)   | 11.0x12.0 |
| FB23995 <sup>c</sup>       | Back Window (Heated)(Solar)  | 30.0x53.0 |

<sup>a</sup> Not On Production Vehicles  
<sup>b</sup> On Production Vehicles

**Genesis (cont.)**

<sup>c</sup> Urethane,Dam,Primer - 2 Tubes  
<sup>d</sup> Fast-Cure Urethane/Dam/Primer - Quantity 2  
<sup>e</sup> Rain Sensor Kit

**Santa Fe 4 Door Utility ..... 2007-2011**

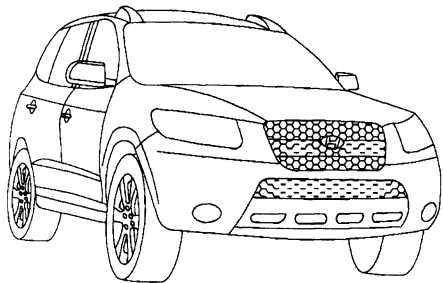

|                                |  |                  |
|--------------------------------|--|------------------|
| <b>FW03251<sup>a,c,d</sup></b> | Windshield (Electrochromic Mirror, W/Third Visor Frit) (10-11)   | <b>35.0x58.0</b> |
| <b>FW03118<sup>c,d</sup></b>   | Windshield (Heated) (Electrochromic Mirror, W/Third Visor Frit, Heated Wiper Park Area) (08-11)        | <b>35.0x58.0</b> |
| <b>FW03117<sup>c,d</sup></b>   | Windshield (Heated) (W/Third Visor Frit, Heated Wiper Park Area) (08-11)                               | <b>35.0x58.0</b> |
| <b>FW02963<sup>b,c,d</sup></b> | Windshield (W/Third Visor Frit)  | <b>35.0x58.0</b> |
| <b>FW02655<sup>c,d</sup></b>   | Windshield (Heated)(Solar) (Electrochromic Mirror, W/Third Visor Frit, Heated Wiper Park Area) (07-09) | <b>35.0x58.0</b> |
| <b>FW02654<sup>c,d</sup></b>   | Windshield (Heated)(Solar) (W/Third Visor Frit, Heated Wiper Park Area) (07-09)                        | <b>35.0x58.0</b> |
| <b>FD23071-72</b>              | Door F/R-L (Solar)   | <b>22.3x32.8</b> |
| <b>FD23075-76</b>              | Door R/R-L (Solar)   | <b>21.8x24.5</b> |
| <b>FD23073-74</b>              | Door R/R-L   | <b>21.8x24.5</b> |
| <b>FQ23083-84<sup>f</sup></b>  | Quarter R-L (Encap)(Solar)   | <b>16.3x22.0</b> |
| <b>FQ23081-82<sup>f</sup></b>  | Quarter R-L (Encap)  | <b>16.3x22.0</b> |
| <b>FV23079-80</b>              | Vent R/R-L (Solar)   | <b>10.3x17.5</b> |
| <b>FV23077-78</b>              | Vent R/R-L   | <b>10.3x17.5</b> |
| <b>FB23086<sup>e</sup></b>     | Back Window (Heated)(1 Holes)(Solar)   | <b>22.3x50.8</b> |
| <b>FB23085<sup>e</sup></b>     | Back Window (Heated)   | <b>22.3x50.8</b> |

<sup>a</sup> Has GM Style Mirror Button  
<sup>b</sup> Has Hyundai Style Mirror Button  
<sup>c</sup> Urethane,Dam,Primer - 2 Tubes  
<sup>d</sup> Fast-Cure Urethane/Dam/Primer - Quantity 2  
<sup>e</sup> Urethane,Dam,Primer - 1.5 Tubes  
<sup>f</sup> Urethane,Dam,Primer - 1 Tube

**Santa Fe 4 Door Utility ..... 2006**

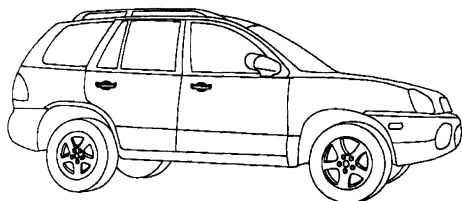

|                              |                               |                  |
|------------------------------|-------------------------------|------------------|
| <b>FW02216<sup>a,b</sup></b> | Windshield                    | <b>35.0x59.0</b> |
| <b>FD21129-30</b>            | Door F/R-L (2 Holes)          | <b>24.0x35.0</b> |
| <b>FD21133-34</b>            | Door R/R-L (2 Holes)(Solar)   | <b>25.0x27.0</b> |
| <b>FD21131-32</b>            | Door R/R-L (2 Holes)          | <b>25.0x27.0</b> |
| <b>FQ21591<sup>c</sup></b>   | Quarter L (Encap)(Solar)      | <b>16.0x20.0</b> |
| <b>FQ21590<sup>c</sup></b>   | Quarter L (Encap)             | <b>16.0x20.0</b> |
| <b>FQ21142<sup>c</sup></b>   | Quarter L (Ant)(Encap)(Solar) | <b>16.0x20.0</b> |
| <b>FQ21140<sup>c</sup></b>   | Quarter L (Ant)(Encap)        | <b>16.0x20.0</b> |
| <b>FQ21141<sup>c</sup></b>   | Quarter R (Encap)(Solar)      | <b>16.0x20.0</b> |
| <b>FQ21139<sup>c</sup></b>   | Quarter R (Encap)             | <b>16.0x20.0</b> |

**Santa Fe (cont.)**

|                   |                                      |                  |
|-------------------|--------------------------------------|------------------|
| <b>FV21137-38</b> | Vent R/R-L (Solar)                   | <b>8.0x17.0</b>  |
| <b>FV21135-36</b> | Vent R/R-L                           | <b>8.0x17.0</b>  |
| <b>FB21144</b>    | Back Window (Heated)(6 Holes)(Solar) | <b>20.5x51.0</b> |
| <b>FB21143</b>    | Back Window (Heated)(6 Holes)        | <b>20.5x51.0</b> |

<sup>a</sup> Urethane,Dam,Primer - 2 Tubes  
<sup>b</sup> Fast-Cure Urethane/Dam/Primer - Quantity 2  
<sup>c</sup> Urethane,Dam,Primer - 1 Tube

**Sonata 4 Door Sedan ..... 2011**

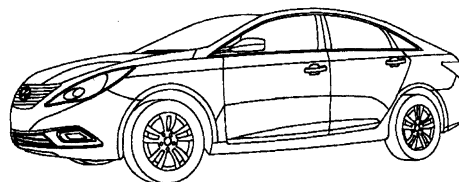

|                               |   |                  |
|-------------------------------|---|------------------|
| <b>FW03250<sup>a,b</sup></b>  | Windshield (Heated)(Solar) (W/Third Visor Frit, Heated Wiper Park Area) | <b>35.0x57.0</b> |
| <b>FW03239<sup>a,b</sup></b>  | Windshield (Solar) (W/Third Visor Frit)                                 | <b>35.0x57.0</b> |
| <b>FD24681-82</b>             | Door F/R-L (Solar)  | <b>17.5x37.5</b> |
| <b>FD24683-84</b>             | Door R/R-L (Solar)  | <b>19.0x30.0</b> |
| <b>FQ24685-86<sup>d</sup></b> | Quarter R-L (Encap)(Solar)  | <b>9.0x15.5</b>  |
| <b>FB24688<sup>c</sup></b>    | Back Window (Ant)(Heated)(Solar)  | <b>30.0x49.0</b> |
| <b>FB24687<sup>c</sup></b>    | Back Window (Heated)(Solar)   | <b>30.0x49.0</b> |

<sup>a</sup> Urethane,Dam,Primer - 2 Tubes  
<sup>b</sup> Fast-Cure Urethane/Dam/Primer - Quantity 2  
<sup>c</sup> Urethane,Dam,Primer - 1.5 Tubes  
<sup>d</sup> Urethane,Dam,Primer - 1 Tube

**Sonata 4 Door Sedan ..... 2006-2010**

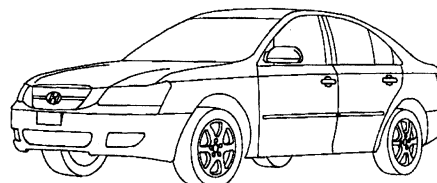

|                              |  |                  |
|------------------------------|--|------------------|
| <b>FW02577<sup>a,b</sup></b> | Windshield (Solar)   | <b>38.7x59.8</b> |
| <b>FW02566<sup>a,b</sup></b> | Windshield (Heated)(Solar) (Electrochromic Mirror, Heated Wiper Park Area) | <b>38.7x59.8</b> |
| <b>FW02565<sup>a,b</sup></b> | Windshield (Heated) (Electrochromic Mirror, Heated Wiper Park Area)        | <b>38.7x59.8</b> |
| <b>FW02564<sup>a,b</sup></b> | Windshield (Solar) (Electrochromic Mirror)                                 | <b>38.7x59.8</b> |
| <b>FW02563<sup>a,b</sup></b> | Windshield (Electrochromic Mirror)   | <b>38.7x59.8</b> |
| <b>FW02562<sup>a,b</sup></b> | Windshield (Heated)(Solar) (Heated Wiper Park Area)                        | <b>38.7x59.8</b> |
| <b>FW02561<sup>a,b</sup></b> | Windshield (Heated) (Heated Wiper Park Area)                               | <b>38.7x59.8</b> |
| <b>FW02560<sup>a,b</sup></b> | Windshield   | <b>38.7x59.8</b> |
| <b>FD22641-42</b>            | Door F/R-L (Solar)   | <b>18.9x36.5</b> |
| <b>FD22639-40</b>            | Door F/R-L   | <b>18.9x36.5</b> |
| <b>FD22645-46</b>            | Door R/R-L (Solar)   | <b>20.5x25.1</b> |
| <b>FD22643-44</b>            | Door R/R-L   | <b>20.5x25.1</b> |
| <b>FV22649-50</b>            | Vent R/R-L (Solar)   | <b>10.8x13.0</b> |
| <b>FV22647-48</b>            | Vent R/R-L   | <b>10.8x13.0</b> |
| <b>FB22652<sup>a</sup></b>   | Back Window (Heated)(Solar)  | <b>31.7x51.9</b> |
| <b>FB22651<sup>a</sup></b>   | Back Window (Heated)   | <b>31.7x51.9</b> |

<sup>a</sup> Urethane,Dam,Primer - 2 Tubes  
<sup>b</sup> Fast-Cure Urethane/Dam/Primer - Quantity 2

**Tiburon 2 Door Hatchback ..... 2006-2009**

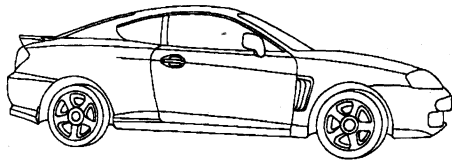

|   |                  |
|---|------------------|
| <b>FW02303<sup>a b</sup></b> Windshield .....                     | <b>33.5x56.0</b> |
| <b>FD21647-48</b> Door F/R-L .....                                | <b>15.5x37.0</b> |
| <b>FQ21649-50<sup>c</sup></b> Quarter R-L (Encap) .....           | <b>12.0x18.0</b> |
| <b>FB21725<sup>a</sup></b> Back Window (Heated) (W/Spoiler) ..... | <b>36.6x50.2</b> |
| <b>FB21651<sup>a</sup></b> Back Window (Heated) .....             | <b>36.6x50.2</b> |

<sup>a</sup> Urethane,Dam,Primer - 2 Tubes  
<sup>b</sup> Fast-Cure Urethane/Dam/Primer - Quantity 2  
<sup>c</sup> Urethane,Dam,Primer - 1 Tube

**Tucson 4 Door Utility ..... 2010-2011**

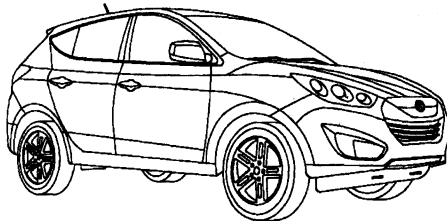

|  |                  |
|--|------------------|
| <b>FW03223<sup>a b</sup></b> Windshield (Heated)(Solar) (Heated Wiper Park Area) ..... | <b>39.5x58.0</b> |
| <b>FW03222<sup>a b</sup></b> Windshield (Heated) (Heated Wiper Park Area) .....        | <b>39.5x58.0</b> |
| <b>FW03221<sup>a b</sup></b> Windshield (Solar) .....                                  | <b>39.5x58.0</b> |
| <b>FW03220<sup>a b</sup></b> Windshield .....  | <b>39.5x58.0</b> |
| <b>FD24595-96</b> Door F/R-L (Solar) .....   | <b>19.0x31.5</b> |
| <b>FD24597-98</b> Door R/R-L (Solar) .....   | <b>19.0x26.5</b> |
| <b>FQ24599-00<sup>d</sup></b> Quarter R-L (Encap)(Solar) .....                         | <b>12.5x18.0</b> |
| <b>FB24601<sup>c</sup></b> Back Window (Heated)(1 Holes)(Solar) (W/Wiper) ...          | <b>19.0x52.0</b> |

<sup>a</sup> Urethane,Dam,Primer - 2 Tubes  
<sup>b</sup> Fast-Cure Urethane/Dam/Primer - Quantity 2  
<sup>c</sup> Urethane,Dam,Primer - 1.5 Tubes  
<sup>d</sup> Urethane,Dam,Primer - 1 Tube

**Tucson 4 Door Utility ..... 2006-2009**

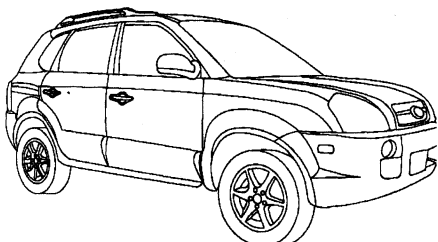

|  |                  |
|--|------------------|
| <b>FW02518<sup>a b</sup></b> Windshield (Heated) (W/Third Visor Frit, W/Compass, Heated Wiper Park Area) ..... | <b>36.4x57.9</b> |
| <b>FW02517<sup>a b</sup></b> Windshield (Heated) (W/Third Visor Frit, Heated Wiper Park Area) .....            | <b>36.4x57.9</b> |
| <b>FW02516<sup>a b</sup></b> Windshield (W/Third Visor Frit) .....   | <b>36.4x57.9</b> |
| <b>FD22504-05</b> Door F/R-L (2 Holes)(Solar) .....  | <b>21.3x35.3</b> |
| <b>FD22506-07</b> Door R/R-L (2 Holes)(Solar) .....  | <b>20.0x30.3</b> |
| <b>FQ22508-09<sup>c</sup></b> Quarter R-L (Encap)(Solar) .....   | <b>15.0x15.0</b> |
| <b>FB24135</b> Back Window (Heated)(7 Holes)(Solar) (1/2" Holes, W/Wiper) .....                                | <b>21.5x47.5</b> |

**Tucson (cont.)**

|  |                  |
|--|------------------|
| <b>FB24134</b> Back Window (Heated)(8 Holes)(Solar) (1/2" Holes) . | <b>21.5x47.5</b> |
|--|------------------|

<sup>a</sup> Urethane,Dam,Primer - 2 Tubes  
<sup>b</sup> Fast-Cure Urethane/Dam/Primer - Quantity 2  
<sup>c</sup> Foam Core Butyl Tape - Quantity 1

**Veracruz 4 Door Utility ..... 2007-2011**

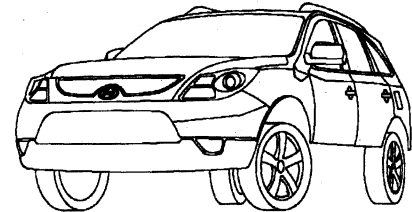

|  |                  |
|--|------------------|
| <b>FW03123<sup>a b d</sup></b> Windshield (Solar) (Electrochromic Mirror) .....  | <b>37.0x61.0</b> |
| <b>FW02832<sup>a b</sup></b> Windshield (Heated)(Solar) (Electrochromic Mirror, Heated Wiper Park Area, Rain Sensor) ..... | <b>37.0x61.0</b> |
| <b>FW02831<sup>a b</sup></b> Windshield (Heated)(Solar) (Electrochromic Mirror, Heated Wiper Park Area) .....              | <b>37.0x61.0</b> |
| <b>FW02830<sup>a b</sup></b> Windshield (Heated)(Solar) (Heated Wiper Park Area) .....                                     | <b>37.0x61.0</b> |
| <b>FW02829<sup>a b</sup></b> Windshield (Solar) (Electrochromic Mirror, Rain Sensor) .....                                 | <b>37.0x61.0</b> |
| <b>FW02828<sup>a b</sup></b> Windshield (Solar) .....  | <b>37.0x61.0</b> |
| <b>FW02827<sup>a b</sup></b> Windshield .....  | <b>37.0x61.0</b> |
| <b>FD23543-44</b> Door F/R-L (Solar) .....   | <b>23.0x36.0</b> |
| <b>FD23541-42</b> Door F/R-L .....   | <b>23.0x36.0</b> |
| <b>FD23545-46</b> Door R/R-L (Solar) .....   | <b>23.0x32.3</b> |
| <b>FQ23547-48<sup>c</sup></b> Quarter R-L (Encap)(Solar) .....   | <b>16.0x27.0</b> |
| <b>FB23549<sup>c</sup></b> Back Window (Heated)(1 Holes)(Solar) (W/Wiper) ...  | <b>23.0x57.0</b> |

<sup>a</sup> Urethane,Dam,Primer - 2 Tubes  
<sup>b</sup> Fast-Cure Urethane/Dam/Primer - Quantity 2  
<sup>c</sup> Urethane,Dam,Primer - 1.5 Tubes  
<sup>d</sup> Rain Sensor Kit  
<sup>e</sup> Urethane,Dam,Primer - 1 Tube

**EX35 4 Door Utility ..... 2008-2011**

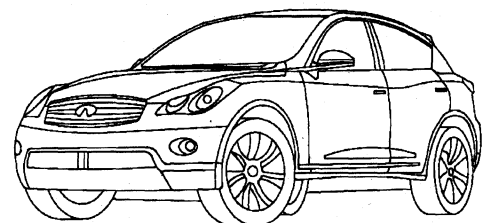

|   |                  |
|---|------------------|
| <b>FW02905<sup>a b</sup></b> Windshield (Solar) (W/Lane Departure Warning System) ..... | <b>36.5x55.0</b> |
| <b>FW02904<sup>a b</sup></b> Windshield (Solar) .....                                   | <b>36.5x55.0</b> |
| <b>FD23707-08</b> Door F/R-L (Solar) .....  | <b>19.0x30.0</b> |
| <b>FD23709-10</b> Door R/R-L (Solar) .....  | <b>19.0x26.0</b> |
| <b>FQ23711-12<sup>d</sup></b> Quarter R-L (Encap)(Solar) .....                          | <b>13.0x15.0</b> |
| <b>FB23713<sup>c</sup></b> Back Window (Heated)(1 Holes)(Solar) .....                   | <b>21.5x48.0</b> |

<sup>a</sup> Urethane,Dam,Primer - 2 Tubes  
<sup>b</sup> Fast-Cure Urethane/Dam/Primer - Quantity 2  
<sup>c</sup> Urethane,Dam,Primer - 1.5 Tubes  
<sup>d</sup> Urethane,Dam,Primer - 1 Tube

**FX35** 4 Door Utility ..... **2009-2011**  
**FX50** 4 Door Utility ..... **2009-2011**

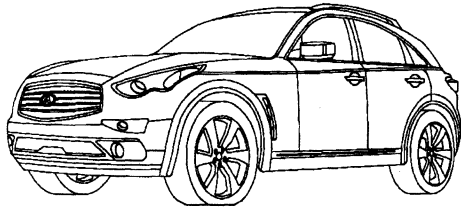

**FW03000<sup>a</sup>** Windshield (Solar) (W/Lane Departure Warning System, Rain Sensor) ..... **36.0x66.0**  
**FW02999<sup>a</sup>** Windshield (Solar) ..... **36.0x66.0**  
**FD24015-16** Door F/R-L (Solar) ..... **20.0x30.0**  
**FD24017-18** Door R/R-L (Solar) ..... **20.0x28.0**  
**FQ24019-20<sup>d</sup>** Quarter R-L (Encap)(Solar) ..... **12.0x17.0**  
**FB24021<sup>c</sup>** Back Window (Ant)(Heated)(1 Holes)(Solar) ..... **20.0x55.0**

<sup>a</sup> Urethane,Dam,Primer - 2 Tubes  
<sup>b</sup> Fast-Cure Urethane/Dam/Primer - Quantity 2  
<sup>c</sup> Urethane,Dam,Primer - 1.5 Tubes  
<sup>d</sup> Urethane,Dam,Primer - 1 Tube

**FX35** 4 Door Utility ..... **2006-2008**

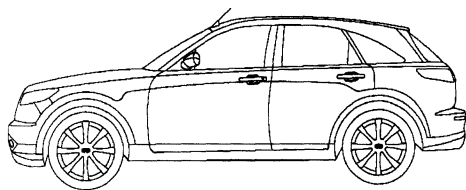

**FW02588<sup>a</sup>** Windshield (Solar) (W/Lane Departure Warning System) ..... **37.0x63.0**  
**FW02394<sup>a</sup>** Windshield (Solar) ..... **37.0x63.0**  
**FD21966-67** Door F/R-L (Solar) ..... **19.0x31.0**  
**FD21968-69** Door R/R-L (Solar) ..... **19.0x27.0**  
**FQ21970-71<sup>d</sup>** Quarter R-L (Encap)(Solar) ..... **12.0x20.5**  
**FB21972<sup>c</sup>** Back Window (Ant)(Heated)(1 Holes)(Solar) ..... **21.5x56.8**

<sup>a</sup> Urethane,Dam,Primer - 2 Tubes  
<sup>b</sup> Fast-Cure Urethane/Dam/Primer - Quantity 2  
<sup>c</sup> Urethane,Dam,Primer - 1.5 Tubes  
<sup>d</sup> Urethane,Dam,Primer - 1 Tube

**FX45** 4 Door Utility ..... **2006-2008**

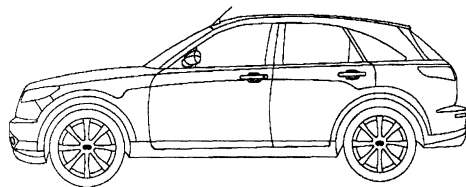

**FW02588<sup>a</sup>** Windshield (Solar) (W/Lane Departure Warning System) ..... **37.0x63.0**  
**FW02394<sup>a</sup>** Windshield (Solar) ..... **37.0x63.0**  
**FD21966-67** Door F/R-L (Solar) ..... **19.0x31.0**  
**FD21968-69** Door R/R-L (Solar) ..... **19.0x27.0**  
**FQ23250-51<sup>d</sup>** Quarter R-L (Encap)(Solar) (Chrome Moulding) ..... **12.0x20.5**  
**FB21972<sup>c</sup>** Back Window (Ant)(Heated)(1 Holes)(Solar) ..... **21.5x56.8**

<sup>a</sup> Urethane,Dam,Primer - 2 Tubes  
<sup>b</sup> Fast-Cure Urethane/Dam/Primer - Quantity 2  
<sup>c</sup> Urethane,Dam,Primer - 1.5 Tubes

**FX45** (cont.)

<sup>d</sup> Urethane,Dam,Primer - 1 Tube

**G35** 2 Door Coupe..... **2006-2007**

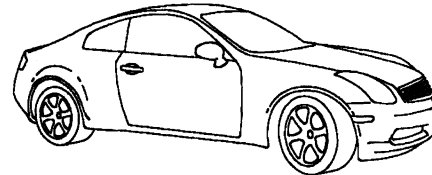

06610008

**FW02367<sup>a</sup>** Windshield (Solar) ..... **33.0x57.5**  
**FD21857-58** Door F/R-L (Solar) ..... **19.0x42.5**  
**FQ21859-60<sup>d</sup>** Quarter R-L (Encap)(Solar) ..... **13.0x22.0**  
**FB21861<sup>c</sup>** Back Window (Heated)(Solar) ..... **34.0x45.5**

<sup>a</sup> Urethane,Dam,Primer - 2 Tubes  
<sup>b</sup> Fast-Cure Urethane/Dam/Primer - Quantity 2  
<sup>c</sup> Urethane,Dam,Primer - 1.5 Tubes  
<sup>d</sup> Urethane,Dam,Primer - 1 Tube

**G35** 4 Door Sedan ..... **2007-2008**

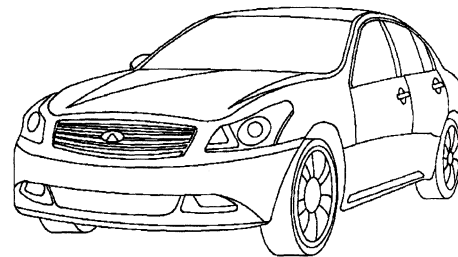

**FW02717<sup>a</sup>** Windshield (Solar) ..... **37.0x55.0**  
**FD23311-12** Door F/R-L (Solar) ..... **18.5x31.0**  
**FD23313-14** Door R/R-L (Solar) ..... **19.0x24.5**  
**FV23315-16** Vent R/R-L (Solar) ..... **11.5x13.0**  
**FB23317<sup>c</sup>** Back Window (Ant)(Heated)(Solar) ..... **28.5x45.5**

<sup>a</sup> Urethane,Dam,Primer - 2 Tubes  
<sup>b</sup> Fast-Cure Urethane/Dam/Primer - Quantity 2  
<sup>c</sup> Urethane,Dam,Primer - 1.5 Tubes

**G35** 4 Door Sedan ..... **2006**

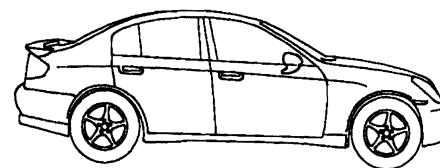

06610007

**FW02332<sup>a</sup>** Windshield (Solar) (Electrochromic Mirror, W/Bullet Shaped Mirror Paint) ..... **36.0x54.5**  
**FW02300<sup>a</sup>** Windshield (Solar) (W/Square Shaped Mirror Paint) .. **36.0x54.5**  
**FD21624-25** Door F/R-L (Solar) ..... **19.0x31.5**  
**FD21626-27** Door R/R-L (Solar) ..... **19.0x23.5**

| <b>G35</b>  | <b>(cont.)</b> |
|---|----------------|
| FW21628-29 Vent R/R-L (Solar)                           | 9.5x12.0       |
| FB21630 <sup>c</sup> Back Window (Ant)(Heated)(Solar)   | 29.0x46.5      |
| <sup>a</sup> Urethane,Dam,Primer - 2 Tubes              |                |
| <sup>b</sup> Fast-Cure Urethane/Dam/Primer - Quantity 2 |                |
| <sup>c</sup> Urethane,Dam,Primer - 1.5 Tubes            |                |

**G37 2 Door Convertible ..... 2009-2011**

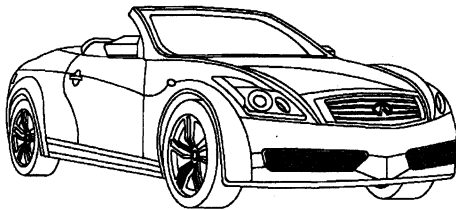

|  |           |
|--|-----------|
| FW03137 <sup>a b d</sup> Windshield (Solar) (Electrochromic Mirror, W/Third Visor Frit, Rain/Light Sensor) | 35.0x57.0 |
| FW02879 <sup>a b</sup> Windshield (Solar) (W/Third Visor Frit)   | 35.0x57.0 |
| FD24393-94 Door F/R-L (Solar)  |           |
| FQ24395-96 Quarter R-L (Solar)   |           |
| FB24397 <sup>c</sup> Back Window (Heated)(Solar)   |           |
| <sup>a</sup> Urethane,Dam,Primer - 2 Tubes   |           |
| <sup>b</sup> Fast-Cure Urethane/Dam/Primer - Quantity 2  |           |
| <sup>c</sup> Urethane,Dam,Primer - 1.5 Tubes   |           |
| <sup>d</sup> Rain Sensor Kit   |           |

**G37 2 Door Coupe ..... 2008-2011**

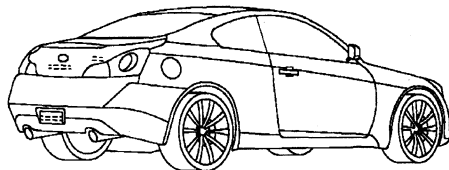

|  |           |
|--|-----------|
| FW03137 <sup>a b d</sup> Windshield (Solar) (Electrochromic Mirror, W/Third Visor Frit, Rain/Light Sensor) (10-11) | 35.0x57.0 |
| FW02879 <sup>a b</sup> Windshield (Solar) (W/Third Visor Frit)   | 35.0x57.0 |
| FD23643-44 Door F/R-L (1 Holes)(Solar)   | 23.0x42.3 |
| FQ23645-46 <sup>e</sup> Quarter R-L (Encap)(Solar)   | 13.5x23.0 |
| FB23647 <sup>c</sup> Back Window (Ant)(Heated)(Solar)  | 33.5x44.5 |
| <sup>a</sup> Urethane,Dam,Primer - 2 Tubes   |           |
| <sup>b</sup> Fast-Cure Urethane/Dam/Primer - Quantity 2  |           |
| <sup>c</sup> Urethane,Dam,Primer - 1.5 Tubes   |           |
| <sup>d</sup> Rain Sensor Kit   |           |
| <sup>e</sup> Urethane,Dam,Primer - 1 Tube  |           |

**G37 4 Door Sedan ..... 2009-2011**

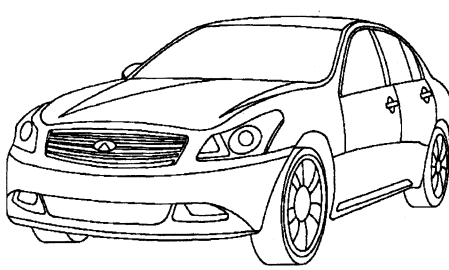

|   |           |
|---|-----------|
| FW03247 <sup>a b d</sup> Windshield (Solar) (Rain Sensor) | 37.0x55.0 |
| FW02717 <sup>a b</sup> Windshield (Solar)                 | 37.0x55.0 |

| <b>G37</b>  | <b>(cont.)</b> |
|---|----------------|
| FD23311-12 Door F/R-L (Solar)                           | 18.5x31.0      |
| FD23313-14 Door R/R-L (Solar)                           | 19.0x24.5      |
| FW23315-16 Vent R/R-L (Solar)                           | 11.5x13.0      |
| FB23317 <sup>c</sup> Back Window (Ant)(Heated)(Solar)   | 28.5x45.5      |
| <sup>a</sup> Urethane,Dam,Primer - 2 Tubes              |                |
| <sup>b</sup> Fast-Cure Urethane/Dam/Primer - Quantity 2 |                |
| <sup>c</sup> Urethane,Dam,Primer - 1.5 Tubes            |                |
| <sup>d</sup> Rain Sensor Kit                            |                |

**M35 4 Door Sedan ..... 2006-2010**  
**M45 4 Door Sedan ..... 2006-2010**

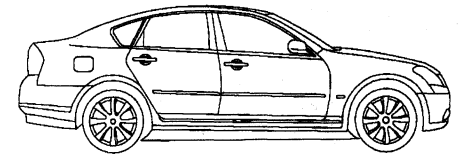

|  |           |
|--|-----------|
| FW02960 <sup>a b</sup> Windshield (Solar) (W/Third Visor Frit, Rain Sensor) (08-10)                                  | 37.6x58.8 |
| FW02956 <sup>a b</sup> Windshield (Solar) (W/Third Visor Frit, W/Lane Departure Warning System, Rain Sensor) (08-10) | 37.6x58.8 |
| FW02572 <sup>a b</sup> Windshield (Solar) (W/Third Visor Frit, W/Lane Departure Warning System) (06-07)              | 37.6x58.8 |
| FW02571 <sup>a b</sup> Windshield (Solar) (W/Third Visor Frit) (06-07)   | 37.6x58.8 |
| FD22668-69 Door F/R-L (Solar)  | 22.8x37.0 |
| FD22670-71 Door R/R-L (Solar)  | 22.5x33.0 |
| FQ22672-73 <sup>c</sup> Quarter R-L (Encap)(Solar)   | 13.0x13.5 |
| FB22674 <sup>a</sup> Back Window (Ant)(Heated)(Solar)  | 34.3x49.5 |
| <sup>a</sup> Urethane,Dam,Primer - 2 Tubes   |           |
| <sup>b</sup> Fast-Cure Urethane/Dam/Primer - Quantity 2  |           |
| <sup>c</sup> Urethane,Dam,Primer - 1 Tube  |           |

**M37 4 Door Sedan ..... 2011**  
**M56 4 Door Sedan ..... 2011**

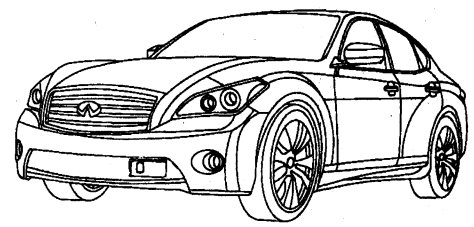

|  |  |
|--|--|
| FW03310 <sup>b c e</sup> Windshield (Solar) (W/Third Visor Frit, W/Lane Departure Warning System, Rain Sensor) |  |
| FW03309 <sup>b c e</sup> Windshield (Solar) (W/Third Visor Frit, Rain Sensor)                                  |  |
| FD24799-00 Door F/R-L (Solar)  |  |
| FD24801-02 Door R/R-L (Solar)  |  |
| FQ24803-04 <sup>a d</sup> Quarter R-L (Encap)(Solar)   |  |
| FB24805 <sup>d</sup> Back Window (Ant)(Heated)(Solar)  |  |
| <sup>a</sup> Non-Reuseable Part  |  |
| <sup>b</sup> Urethane,Dam,Primer - 2 Tubes   |  |
| <sup>c</sup> Fast-Cure Urethane/Dam/Primer - Quantity 2  |  |
| <sup>d</sup> Urethane,Dam,Primer - 1.5 Tubes   |  |
| <sup>e</sup> Rain Sensor Kit   |  |

**Q45 4 Door Sedan..... 2006**

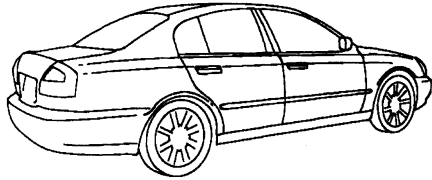

06610010

|   |           |
|---|-----------|
| FW02527 <sup>a b d</sup> Windshield (Solar) (Rain Sensor) ..... | 37.0x59.8 |
| FD21384-85 Door F/R-L (Solar) .....                             | 20.0x33.0 |
| FD21388-89 Door R/R-L (Solar) .....                             | 20.0x25.0 |
| FD21386-87 Door R/R-L (Solar) (W/Sunshade) .....                | 20.0x25.0 |
| FV21390-91 Vent R/R-L (Solar) .....                             | 10.5x13.0 |
| FB21392 <sup>c</sup> Back Window (Ant)(Heated)(Solar) .....     | 25.0x51.0 |

<sup>a</sup> Urethane,Dam,Primer - 2 Tubes  
<sup>b</sup> Fast-Cure Urethane/Dam/Primer - Quantity 2  
<sup>c</sup> Urethane,Dam,Primer - 1.5 Tubes  
<sup>d</sup> Rain Sensor Kit

**QX56 4 Door Utility..... 2011**

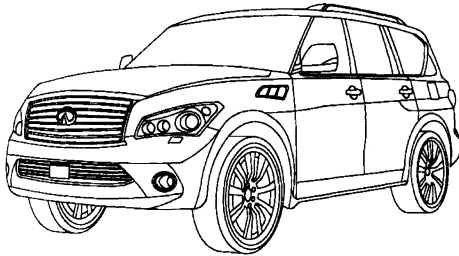

|   |           |
|---|-----------|
| FW03333 <sup>a b c</sup> Windshield (Acoustic Interlayer, W/Lane Departure Warning System, Rain Sensor) ..... |           |
| FW03249 <sup>a b c</sup> Windshield (Heated) (Acoustic Interlayer, Heated Wiper Park Area, Rain Sensor) ..... |           |
| FW03248 <sup>a b c</sup> Windshield (Acoustic Interlayer, Rain Sensor) .....                                  |           |
| FD24704-05 Door F/R-L (Laminated) .....   | 23.0x36.5 |
| FD24706-07 Door R/R-L (Solar) .....   | 21.8x29.0 |
| FQ24710-11 Quarter R-L (Solar) .....  |           |
| FV24708-09 Vent R/R-L (Solar) .....   |           |
| FB24712 <sup>d</sup> Back Window (Heated)(Solar) .....  |           |

<sup>a</sup> May Require Two Person Installation  
<sup>b</sup> Urethane,Dam,Primer - 2 Tubes  
<sup>c</sup> Fast-Cure Urethane/Dam/Primer - Quantity 2  
<sup>d</sup> Urethane,Dam,Primer - 1.5 Tubes

**QX56 4 Door Utility..... 2006-2010**

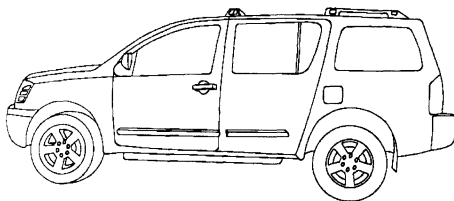

|  |           |
|--|-----------|
| FW02391 <sup>a b c</sup> Windshield .....          | 34.8x63.9 |
| FD23967-68 Door F/R-L (Laminated) (07-10) .....    | 27.2x39.2 |
| FD21945-46 Door F/R-L (06) .....                   | 27.2x39.2 |
| FD22144-45 Door R/R-L (Solar) .....                | 26.3x30.2 |
| FQ22150-51 Quarter R-L (Ant)(Solar) (Power) .....  | 19.1x36.1 |
| FQ22148-49 Quarter R-L (Ant)(Solar) (Manual) ..... | 19.1x36.1 |

**QX56 (cont.)**

|   |           |
|---|-----------|
| FV22146-47 Vent R/R-L (Solar) .....       | 8.6x20.4  |
| FB22153 Back Window (Heated)(Solar) ..... | 20.1x60.2 |

<sup>a</sup> May Require Two Person Installation  
<sup>b</sup> Urethane,Dam,Primer - 2 Tubes  
<sup>c</sup> Fast-Cure Urethane/Dam/Primer - Quantity 2

**Isuzu**

**Ascender 5 PASSENGER 4 Door Utility..... 2006-2009**

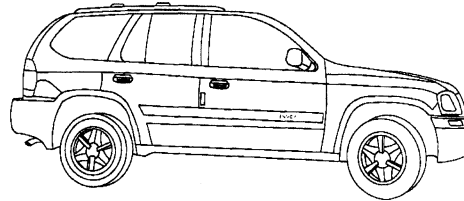

|  |           |
|--|-----------|
| DW01611 <sup>b c d</sup> Windshield (Solar) (W/Third Visor Frit, Acoustic Interlayer, Rain Sensor) ..... | 33.4x59.6 |
| DW01610 <sup>b c d</sup> Windshield (Solar) (W/Third Visor Frit, Acoustic Interlayer) .....              | 33.4x59.6 |
| DW01585 <sup>a c d</sup> Windshield (Solar) (W/Third Visor Frit, Rain Sensor) .....                      | 33.4x59.6 |
| DW01584 <sup>a c d</sup> Windshield (Solar) (W/Third Visor Frit) .....                                   | 33.4x59.6 |
| DW01446 <sup>c d</sup> Windshield (Export Only, Rain Sensor) .....                                       | 33.4x59.6 |
| DW01445 <sup>c d</sup> Windshield (Export Only) .....  | 33.4x59.6 |
| DD09965-66 Door F/R-L (Solar) .....  | 21.5x34.0 |
| DD09967-68 Door R/R-L (Solar) .....  | 18.5x21.5 |
| DQ10561-62 <sup>e</sup> Quarter R-L (Encap)(Solar) .....   | 20.3x35.3 |
| DV09971-72 Vent R/R-L (Encap)(Solar) .....   | 10.5x20.0 |
| DB09983 Back Window (Heated)(Solar) (Movable) .....  | 26.0x54.0 |
| DB09982 Back Window (Solar) (Movable) .....  | 26.0x54.0 |

<sup>a</sup> Not On Production Vehicles  
<sup>b</sup> On Production Vehicles  
<sup>c</sup> Urethane,Dam,Primer - 2 Tubes  
<sup>d</sup> Fast-Cure Urethane/Dam/Primer - Quantity 2  
<sup>e</sup> Urethane,Dam,Primer - 1.5 Tubes

**Ascender 7 PASSENGER 4 Door Utility..... 2006**

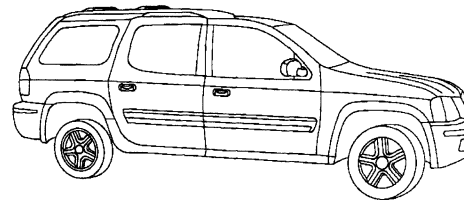

|  |           |
|--|-----------|
| DW01611 <sup>b c d</sup> Windshield (Solar) (W/Third Visor Frit, Acoustic Interlayer, Rain Sensor) ..... | 33.4x59.6 |
| DW01610 <sup>b c d</sup> Windshield (Solar) (W/Third Visor Frit, Acoustic Interlayer) .....              | 33.4x59.6 |
| DW01585 <sup>a c d</sup> Windshield (Solar) (W/Third Visor Frit, Rain Sensor) .....                      | 33.4x59.6 |
| DW01584 <sup>a c d</sup> Windshield (Solar) (W/Third Visor Frit) .....                                   | 33.4x59.6 |
| DW01446 <sup>c d</sup> Windshield (Export Only, Rain Sensor) .....                                       | 33.4x59.6 |
| DW01445 <sup>c d</sup> Windshield (Export Only) .....  | 33.4x59.6 |
| DD09965-66 Door F/R-L (Solar) .....  | 21.5x34.0 |
| DD10305-06 Door R/R-L (Solar) .....  | 22.0x22.8 |
| DQ10906-07 <sup>e</sup> Quarter R-L (Encap)(Solar) (Stationary) .....                                    | 17.2x38.0 |
| DQ10567-68 <sup>e</sup> Quarter R-L (Encap)(1 Holes)(Solar) (Movable) .....                              | 17.2x38.0 |
| DV10312-13 Vent R/R-L (Encap)(Solar) .....   | 8.0x18.8  |
| DB11124 Back Window (2 Holes)(Solar) (Movable) .....   | 28.5x55.0 |
| DB10317 Back Window (Heated)(2 Holes)(Solar) .....   | 28.5x55.0 |

<sup>a</sup> Not On Production Vehicles



**Ascender**

(cont.)

- <sup>b</sup> On Production Vehicles
- <sup>c</sup> Urethane,Dam,Primer - 2 Tubes
- <sup>d</sup> Fast-Cure Urethane/Dam/Primer - Quantity 2
- <sup>e</sup> Urethane,Dam,Primer - 1.5 Tubes

|  |                  |
|--|------------------|
| <b>i-280</b> 2 Door Extended Cab ..... | <b>2006</b>      |
| <b>i-290</b> 2 Door Extended Cab ..... | <b>2007-2009</b> |
| <b>i-370</b> 2 Door Extended Cab ..... | <b>2007-2009</b> |

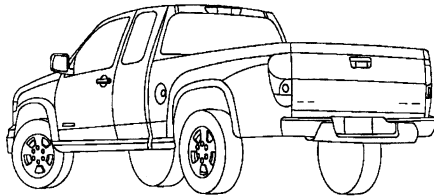

|  |                  |
|--|------------------|
| <b>DW01533<sup>a,b</sup></b> Windshield (06-09) .....  | <b>32.0x57.4</b> |
| <b>DD10498-99</b> Door F/R-L (06-09) .....   | <b>21.0x34.0</b> |
| <b>DQ10503-04<sup>d</sup></b> Quarter R-L (Solar) (06-09) .....  | <b>15.3x18.8</b> |
| <b>DY90108<sup>c</sup></b> Back Window (Encap)(Slider)(Solar) (Black Frame, Aftermarket, Power, 3 Panel Encapsulated) (06-09) .....  | <b>13.7x54.0</b> |
| <b>DY90107<sup>c</sup></b> Back Window (Encap)(Slider)(Solar) (Black Frame, Aftermarket, Manual, 3 Panel Encapsulated) (06-09) ..... | <b>13.7x54.0</b> |
| <b>DB10507<sup>c</sup></b> Back Window (Encap)(Slider)(Solar) (OE) (06-09) .....   | <b>13.7x54.0</b> |
| <b>DB10500<sup>c</sup></b> Back Window (Solar) (Stationary) (06-09) .....  | <b>13.7x54.0</b> |

- <sup>a</sup> Urethane,Dam,Primer - 2 Tubes
- <sup>b</sup> Fast-Cure Urethane/Dam/Primer - Quantity 2
- <sup>c</sup> Urethane,Dam,Primer - 1.5 Tubes
- <sup>d</sup> Urethane,Dam,Primer - 1 Tube

|                                    |                  |
|------------------------------------|------------------|
| <b>i-350</b> 4 Door Crew Cab ..... | <b>2006</b>      |
| <b>i-370</b> 4 Door Crew Cab ..... | <b>2007-2009</b> |

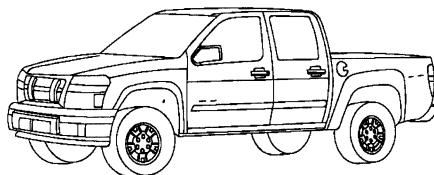

|  |                  |
|--|------------------|
| <b>DW01533<sup>a,b</sup></b> Windshield (06-09) .....  | <b>32.0x57.4</b> |
| <b>DD10498-99</b> Door F/R-L (06-09) .....   | <b>21.0x34.0</b> |
| <b>DD10505-06</b> Door R/R-L (Solar) (06-09) .....   | <b>21.0x24.0</b> |
| <b>DY90108<sup>c</sup></b> Back Window (Encap)(Slider)(Solar) (Black Frame, Aftermarket, Power, 3 Panel Encapsulated) (06-09) .....  | <b>13.7x54.0</b> |
| <b>DY90107<sup>c</sup></b> Back Window (Encap)(Slider)(Solar) (Black Frame, Aftermarket, Manual, 3 Panel Encapsulated) (06-09) ..... | <b>13.7x54.0</b> |
| <b>DB10507<sup>c</sup></b> Back Window (Encap)(Slider)(Solar) (OE) (06-09) .....   | <b>13.7x54.0</b> |
| <b>DB10500<sup>c</sup></b> Back Window (Solar) (Stationary) (06-09) .....  | <b>13.7x54.0</b> |

- <sup>a</sup> Urethane,Dam,Primer - 2 Tubes
- <sup>b</sup> Fast-Cure Urethane/Dam/Primer - Quantity 2
- <sup>c</sup> Urethane,Dam,Primer - 1.5 Tubes

**S-Type 4 Door Sedan..... 2006-2008**

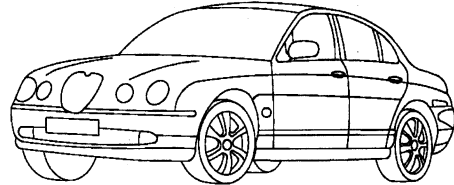

|  |                  |
|--|------------------|
| <b>FW02551<sup>a</sup></b> Windshield (Solar) .....  | <b>32.0x54.0</b> |
| <b>FW02550<sup>a</sup></b> Windshield (Solar) (Rain Sensor) .....  | <b>32.0x54.0</b> |
| <b>FW02549<sup>a</sup></b> Windshield (Heated)(Solar) (Electrochromic Mirror, Fully Heated, Rain Sensor) ..... | <b>32.0x54.0</b> |
| <b>FW02548<sup>a</sup></b> Windshield (Heated)(Solar) (Electrochromic Mirror, Fully Heated) .....              | <b>32.0x54.0</b> |
| <b>FD20791-92</b> Door F/R-L (Solar) .....   | <b>22.0x36.0</b> |
| <b>FD20793-94</b> Door R/R-L (1 Holes)(Solar) .....  | <b>21.0x24.5</b> |
| <b>FV20795-96</b> Vent R/R-L (Solar) .....   | <b>11.3x13.3</b> |
| <b>FB22013<sup>a</sup></b> Back Window (Ant)(Heated)(Solar) (W/Diversity Antenna, W/TV Antenna) .....          | <b>23.7x57.5</b> |
| <b>FB22012<sup>a</sup></b> Back Window (Ant)(Heated)(Solar) (W/TV Antenna) .....                               | <b>23.7x57.5</b> |
| <b>FB22011<sup>a</sup></b> Back Window (Ant)(Heated)(Solar) (W/Diversity Antenna) .....                        | <b>23.7x57.5</b> |
| <b>FB22010<sup>a</sup></b> Back Window (Heated)(Solar) .....   | <b>23.7x57.5</b> |

<sup>a</sup> High Modulus Non-Conductive Urethane,Dam,Primer - 2 Tubes

|                                       |                  |
|---------------------------------------|------------------|
| <b>Vanden Plas</b> 4 Door Sedan ..... | <b>2006-2009</b> |
| <b>XJ Super</b> 4 Door Sedan .....    | <b>2006-2009</b> |
| <b>XJ8L</b> 4 Door Sedan .....        | <b>2006-2009</b> |

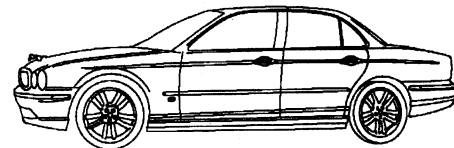

|  |                  |
|--|------------------|
| <b>FW02663<sup>a</sup></b> Windshield (Heated)(Solar) (Acoustic Interlayer, Rain Sensor) ..... | <b>36.5x63.0</b> |
| <b>FW02662<sup>a</sup></b> Windshield (Solar) (Acoustic Interlayer, Rain Sensor) .....         | <b>36.5x63.0</b> |
| <b>FD24638-39</b> Door F/R-L (Solar) (Laminated) .....   | <b>19.0x32.0</b> |
| <b>FD22121-22</b> Door F/R-L (1 Holes)(Solar) .....  | <b>19.0x32.0</b> |
| <b>FD24642-43</b> Door R/R-L (Solar) (Laminated, 124" WB, LWB) .....                           | <b>19.0x30.0</b> |
| <b>FD23060-61</b> Door R/R-L (Solar) (124" WB, LWB) .....                                      | <b>19.0x30.0</b> |
| <b>FV22125-26</b> Vent R/R-L (Encap)(Solar) .....  | <b>9.8x12.0</b>  |
| <b>FB22128<sup>a</sup></b> Back Window (Ant)(Heated)(Solar) (W/TV Antenna) .....               | <b>29.5x61.8</b> |
| <b>FB22127<sup>a</sup></b> Back Window (Ant)(Heated)(Solar) .....                              | <b>29.5x61.8</b> |

<sup>a</sup> High Modulus Non-Conductive Urethane,Dam,Primer - 2 Tubes

**X Type 4 Door Sedan..... 2006-2008**

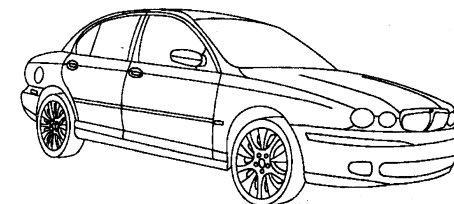

| <i>X Type</i>        | <i>(cont.)</i>   |
|----------------------|--|
| FW02667 <sup>a</sup> | Windshield (Heated)(Solar) (Electrochromic Mirror, PAAS System, W/Third Visor Frit, Rain Sensor, Fine Wire Heated) ..... 36.0x56.5 |
| FW02666 <sup>a</sup> | Windshield (Heated)(Solar) (PAAS System, W/Third Visor Frit, Fine Wire Heated) ..... 36.0x56.5                                     |
| FW02665 <sup>a</sup> | Windshield (Solar) (Electrochromic Mirror, PAAS System, W/Third Visor Frit, Rain Sensor) ..... 36.0x56.5                           |
| FW02664 <sup>a</sup> | Windshield (Solar) (PAAS System, W/Third Visor Frit) ..... 36.0x56.5   |
| FD21495-96           | Door F/R-L (Solar) ..... 19.0x33.0   |
| FD21497-98           | Door R/R-L (Solar) ..... 19.0x22.5   |
| FV23441-42           | Vent R/R-L (Solar) (Chrome Frame) (07-08) ..... 9.5x12.5   |
| FV23439-40           | Vent R/R-L (Solar) (Flat Black Frame) (07-08) ..... 9.5x12.5   |
| FV21500-01           | Vent R/R-L (Solar) (Glossy Black Frame) ..... 9.5x12.5   |
| FB22081 <sup>b</sup> | Back Window (Ant)(Heated)(Solar) (PAAS System, W/TV Antenna, W/GPS Antenna) ..... 25.8x53.0  |
| FB22080 <sup>b</sup> | Back Window (Ant)(Heated)(Solar) (PAAS System, W/GPS Antenna) ..... 25.8x53.0  |
| FB21503 <sup>b</sup> | Back Window (Ant)(Heated)(Solar) (PAAS System, W/TV Antenna) ..... 25.8x53.0   |
| FB21502 <sup>b</sup> | Back Window (Ant)(Heated)(Solar) (PAAS System) .. 25.8x53.0  |

| <i>XF</i>            | <i>(cont.)</i>  |
|----------------------|---|
| FW03174 <sup>a</sup> | Windshield (Solar) (W/Third Visor Frit, Acoustic Interlayer, Rain Sensor) (10-11) ..... 39.0x60.0 |
| FW02943 <sup>a</sup> | Windshield (Heated)(Solar) (W/Third Visor Frit, Rain Sensor) (09) ..... 39.0x60.0                 |
| FW02942 <sup>a</sup> | Windshield (Solar) (W/Third Visor Frit, Rain Sensor) (09) ..... 39.0x60.0                         |
| FD23851-52           | Door F/R-L (2 Holes)(Solar) (09-11) ..... 24.3x37.3   |
| FD23853-54           | Door R/R-L (1 Holes)(Solar) (09-11) ..... 22.0x25.5   |
| FV23855-56           | Vent R/R-L (Encap)(Solar) (09-11) ..... 9.0x10.0  |
| FB23857 <sup>b</sup> | Back Window (Ant)(Heated)(Solar) (09-11) ..... 31.0x46.0  |

**XJ 4 Door Sedan..... 2010-2011**

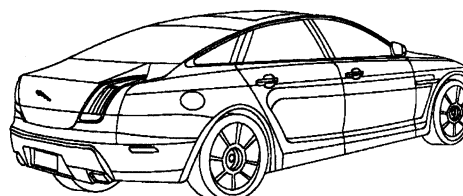

|                         |  |
|-------------------------|--|
| FW03182 <sup>a</sup>    | Windshield (Encap)(Heated)(Solar) (Acoustic Interlayer, Rain Sensor) ..... 43.0x57.0     |
| FW03181 <sup>a</sup>    | Windshield (Encap)(Solar) (Acoustic Interlayer, Rain Sensor) ..... 43.0x57.0             |
| FD24524-25              | Door F/R-L (Solar) (Laminated, Hydrophobic Coating, Acoustic Interlayer) ..... 18.0x31.0 |
| FD24526-27              | Door R/R-L (Solar) (Laminated) ..... 18.0x26.0   |
| FQ24530-31 <sup>c</sup> | Quarter R-L (Encap)(Solar) ..... 13.0x23.0   |
| FB24532 <sup>b</sup>    | Back Window (Ant)(Heated)(Solar) (Laminated) ..... 32.0x45.5                             |

**XJ8 4 Door Sedan ..... 2006-2009**  
**XJR 4 Door Sedan ..... 2006-2009**

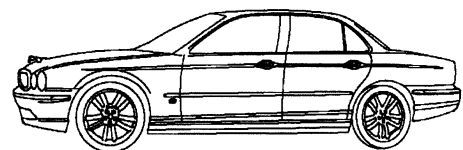

|                      |   |
|----------------------|---|
| FW02663 <sup>a</sup> | Windshield (Heated)(Solar) (Acoustic Interlayer, Rain Sensor) ..... 36.5x63.0 |
| FW02662 <sup>a</sup> | Windshield (Solar) (Acoustic Interlayer, Rain Sensor) ..... 36.5x63.0         |
| FD24638-39           | Door F/R-L (Solar) (Laminated) ..... 19.0x32.0                                |
| FD22121-22           | Door F/R-L (1 Holes)(Solar) ..... 19.0x32.0                                   |
| FD24640-41           | Door R/R-L (Solar) (Laminated, 119" WB) ..... 19.0x25.0                       |
| FD22123-24           | Door R/R-L (1 Holes)(Solar) (119" WB) ..... 19.0x25.0                         |
| FV22125-26           | Vent R/R-L (Encap)(Solar) ..... 9.8x12.0                                      |
| FB22128 <sup>a</sup> | Back Window (Ant)(Heated)(Solar) (W/TV Antenna) ..... 29.5x61.8               |
| FB22127 <sup>a</sup> | Back Window (Ant)(Heated)(Solar) ..... 29.5x61.8                              |

**X Type 4 Door Station Wagon ..... 2006-2008**

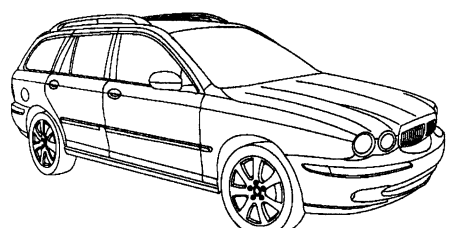

|                         |  |
|-------------------------|--|
| FW02667 <sup>a</sup>    | Windshield (Heated)(Solar) (Electrochromic Mirror, PAAS System, W/Third Visor Frit, Rain Sensor, Fine Wire Heated) ..... 36.0x56.5 |
| FW02666 <sup>a</sup>    | Windshield (Heated)(Solar) (PAAS System, W/Third Visor Frit, Fine Wire Heated) ..... 36.0x56.5                                     |
| FW02665 <sup>a</sup>    | Windshield (Solar) (Electrochromic Mirror, PAAS System, W/Third Visor Frit, Rain Sensor) ..... 36.0x56.5                           |
| FW02664 <sup>a</sup>    | Windshield (Solar) (PAAS System, W/Third Visor Frit) ..... 36.0x56.5   |
| FD21495-96              | Door F/R-L (Solar) ..... 19.0x33.0   |
| FD22497-98              | Door R/R-L (Solar) ..... 19.0x33.0   |
| FQ22501-02 <sup>b</sup> | Quarter R-L (Encap)(Solar) (Chrome Frame) ..... 15.0x30.0  |
| FV22499-00              | Vent R/R-L (Solar) ..... 7.5x15.0  |
| FB22503                 | Back Window (Heated)(Solar) ..... 21.0x50.0  |

**XF 4 Door Sedan..... 2009-2011**  
**XFR 4 Door Sedan ..... 2010-2011**

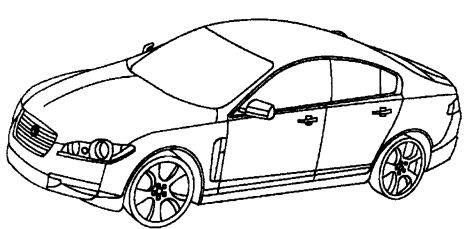

|                      |   |
|----------------------|---|
| FW03175 <sup>a</sup> | Windshield (Heated)(Solar) (W/Third Visor Frit, Acoustic Interlayer, Rain Sensor) (10-11) ..... 39.0x60.0 |
|----------------------|---|

**XJL 4 Door Sedan..... 2010-2011**

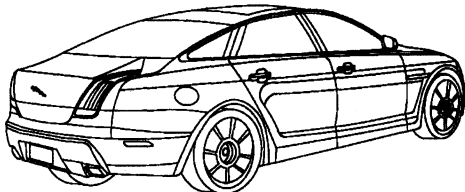

|                               |  |                  |
|-------------------------------|--|------------------|
| <b>FW03182<sup>a</sup></b>    | Windshield (Encap)(Heated)(Solar) (Acoustic Interlayer, Rain Sensor) .....     | <b>43.0x57.0</b> |
| <b>FW03181<sup>a</sup></b>    | Windshield (Encap)(Solar) (Acoustic Interlayer, Rain Sensor) .....             | <b>43.0x57.0</b> |
| <b>FD24524-25</b>             | Door F/R-L (Solar) (Laminated, Hydrophobic Coating, Acoustic Interlayer) ..... | <b>18.0x31.0</b> |
| <b>FD24528-29</b>             | Door R/R-L (Solar) (Laminated) .....   | <b>18.0x31.0</b> |
| <b>FQ24530-31<sup>c</sup></b> | Quarter R-L (Encap)(Solar) .....   | <b>13.0x23.0</b> |
| <b>FB24532<sup>b</sup></b>    | Back Window (Ant)(Heated)(Solar) (Laminated) .....                             | <b>32.0x45.5</b> |

<sup>a</sup> High Modulus Non-Conductive Urethane,Dam,Primer - 2 Tubes  
<sup>b</sup> High Modulus Non-Conductive Urethane,Dam,Primer - 1.5 Tubes  
<sup>c</sup> High Modulus Non-Conductive Urethane,Dam,Primer - 1 Tube

**XK 2 Door Convertible..... 2007-2011**  
**XKR 2 Door Convertible ..... 2007-2011**

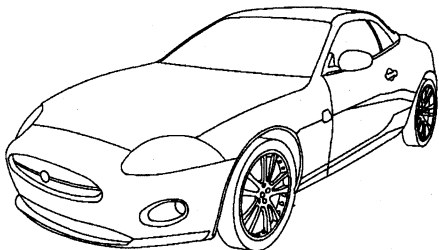

|                            |  |                  |
|----------------------------|--|------------------|
| <b>FW02658<sup>a</sup></b> | Windshield (Heated) (PAAS System, Rain Sensor) ..... | <b>34.0x60.0</b> |
| <b>FW02657<sup>a</sup></b> | Windshield (PAAS System, Rain Sensor) .....          | <b>34.0x60.0</b> |
| <b>FD23096-97</b>          | Door F/R-L .....                                     | <b>14.0x37.0</b> |
| <b>FQ23101-02</b>          | Quarter R-L .....                                    | <b>14.0x15.5</b> |

<sup>a</sup> High Modulus Non-Conductive Urethane,Dam,Primer - 2 Tubes

**XK 2 Door Coupe..... 2007-2011**  
**XKR 2 Door Coupe..... 2007-2011**

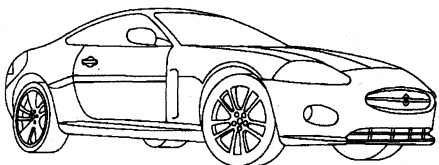

|                               |  |                  |
|-------------------------------|--|------------------|
| <b>FW02658<sup>a</sup></b>    | Windshield (Heated) (PAAS System, Rain Sensor) ..... | <b>34.0x60.0</b> |
| <b>FW02657<sup>a</sup></b>    | Windshield (PAAS System, Rain Sensor) .....          | <b>34.0x60.0</b> |
| <b>FD23096-97</b>             | Door F/R-L .....                                     | <b>14.0x37.0</b> |
| <b>FQ23098-99<sup>c</sup></b> | Quarter R-L (Encap) .....                            | <b>12.0x22.5</b> |
| <b>FB23100<sup>b</sup></b>    | Back Window .....                                    | <b>36.0x36.5</b> |

<sup>a</sup> High Modulus Non-Conductive Urethane,Dam,Primer - 2 Tubes  
<sup>b</sup> High Modulus Non-Conductive Urethane,Dam,Primer - 1.5 Tubes  
<sup>c</sup> High Modulus Non-Conductive Urethane,Dam,Primer - 1 Tube

**XK8 2 Door Convertible..... 2006**  
**XKR 2 Door Convertible..... 2006**

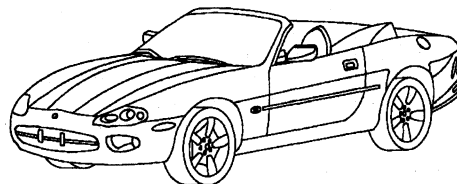

|                            |  |                  |
|----------------------------|--|------------------|
| <b>FW02363<sup>a</sup></b> | Windshield (Rain Sensor, Light Sensor) ..... | <b>32.0x65.0</b> |
| <b>FW02251<sup>a</sup></b> | Windshield (Heated) (Rain Sensor) .....      | <b>32.0x65.0</b> |
| <b>FW02027<sup>a</sup></b> | Windshield (Heated) .....                    | <b>32.0x65.0</b> |
| <b>FW02026<sup>a</sup></b> | Windshield .....                             | <b>32.0x65.0</b> |
| <b>FD20176-77</b>          | Door F/R-L .....                             | <b>17.0x34.5</b> |
| <b>FQ20178-79</b>          | Quarter R-L .....                            | <b>12.0x13.0</b> |
| <b>FB20180</b>             | Back Window (Heated) .....                   | <b>17.7x40.0</b> |

<sup>a</sup> High Modulus Urethane,Dam,Primer - 2 Tubes

**XK8 2 Door Coupe ..... 2006**  
**XKR 2 Door Coupe ..... 2006**

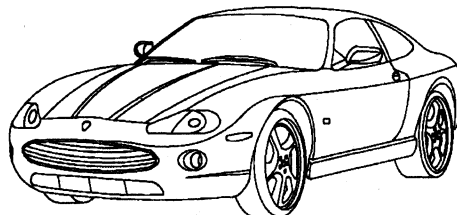

|                               |  |                  |
|-------------------------------|--|------------------|
| <b>FW02363<sup>b</sup></b>    | Windshield (Rain Sensor, Light Sensor) ..... | <b>32.0x65.0</b> |
| <b>FW02251<sup>b</sup></b>    | Windshield (Heated) (Rain Sensor) .....      | <b>32.0x65.0</b> |
| <b>FW02027<sup>b</sup></b>    | Windshield (Heated) .....                    | <b>32.0x65.0</b> |
| <b>FW02026<sup>b</sup></b>    | Windshield .....                             | <b>32.0x65.0</b> |
| <b>FD20146-47</b>             | Door F/R-L .....                             | <b>18.2x33.5</b> |
| <b>FQ20148-49<sup>c</sup></b> | Quarter R-L .....                            | <b>13.5x25.8</b> |
| <b>FB20150<sup>a</sup></b>    | Back Window (Heated) .....                   | <b>33.5x47.0</b> |

<sup>a</sup> High Modulus Urethane,Dam,Primer - 1.5 Tubes  
<sup>b</sup> High Modulus Urethane,Dam,Primer - 2 Tubes  
<sup>c</sup> High Modulus Urethane,Dam,Primer - 1 Tube

**Commander 4 Door Utility ..... 2006-2011**

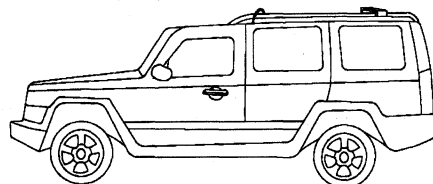

|                                |  |                  |
|--------------------------------|--|------------------|
| <b>DW01701<sup>a,b,c</sup></b> | Windshield (W/Third Visor Frit, Rain Sensor) (From 10/23/2006) (07-11) ..... | <b>28.5x66.5</b> |
| <b>DW01700<sup>a,b,c</sup></b> | Windshield (W/Third Visor Frit) (From 10/23/2006) (07-11) .....              | <b>28.5x66.5</b> |
| <b>DW01628<sup>b,c</sup></b>   | Windshield (W/Third Visor Frit, Rain Sensor) (To 10/23/2006) (06-07) .....   | <b>28.5x66.5</b> |
| <b>DW01627<sup>b,c</sup></b>   | Windshield (W/Third Visor Frit) (To 10/23/2006) (06-07) .....                | <b>28.5x66.5</b> |
| <b>DD11129-30</b>              | Door F/R-L (From 01/03/2006) .....   | <b>21.0x33.1</b> |
| <b>DD10983-84</b>              | Door F/R-L (Laminated, Secure Shield Logo) (To 01/03/2006) (06) .....        | <b>21.0x33.1</b> |

**Commander**

(cont.)

|                               |  |           |
|-------------------------------|--|-----------|
| <b>DD10985-86</b>             | Door R/R-L (Solar)                           | 20.0x27.0 |
| <b>DR11033</b>                | Roof F (Encap)(Solar) (Power)                |           |
| <b>DR11034-35</b>             | Roof R/R-L (Encap)(Solar)                    | 16.0x22.0 |
| <b>DQ10989-90<sup>e</sup></b> | Quarter R-L (Encap)(Solar)                   | 18.0x26.6 |
| <b>DV10987-88</b>             | Vent R/R-L (Solar)                           | 9.5x18.0  |
| <b>DB11686<sup>d</sup></b>    | Back Window (Heated)(6 Holes)(Solar) (09-11) | 18.0x51.0 |
| <b>DB11505<sup>d</sup></b>    | Back Window (Heated)(6 Holes)(Solar) (08)    | 18.0x51.0 |
| <b>DB10991<sup>d</sup></b>    | Back Window (Heated)(6 Holes)(Solar) (06-07) | 18.0x51.0 |

- <sup>a</sup> Per Chrysler, No Upper Moulding Required
- <sup>b</sup> Urethane,Dam,Primer - 2 Tubes
- <sup>c</sup> Fast-Cure Urethane/Dam/Primer - Quantity 2
- <sup>d</sup> Urethane,Dam,Primer - 1.5 Tubes
- <sup>e</sup> Urethane,Dam,Primer - 1 Tube

**Compass 4 Door Utility**..... 2007-2011

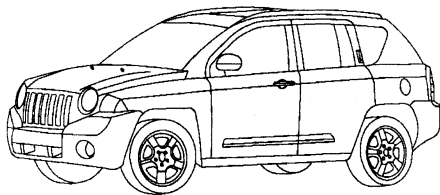

|                               |  |           |
|-------------------------------|--|-----------|
| <b>DW01662<sup>a,b</sup></b>  | Windshield (Solar) (W/Third Visor Frit)        | 33.1x55.7 |
| <b>DD11181-82</b>             | Door F/R-L (2 Holes)(Solar)                    | 22.0x36.0 |
| <b>DD11183-84</b>             | Door R/R-L (1 Holes)(Solar)                    | 19.5x21.0 |
| <b>DQ11187-88<sup>d</sup></b> | Quarter R-L (Encap)(Solar)                     | 15.1x15.5 |
| <b>DV11185-86</b>             | Vent R/R-L (Encap)(Solar)                      | 7.5x15.5  |
| <b>DB11189<sup>c</sup></b>    | Back Window (Heated)(1 Holes)(Solar) (W/Wiper) | 21.0x51.0 |

- <sup>a</sup> Urethane,Dam,Primer - 2 Tubes
- <sup>b</sup> Fast-Cure Urethane/Dam/Primer - Quantity 2
- <sup>c</sup> Urethane,Dam,Primer - 1.5 Tubes
- <sup>d</sup> Urethane,Dam,Primer - 1 Tube

**Grand Cherokee 4 Door Utility**..... 2011

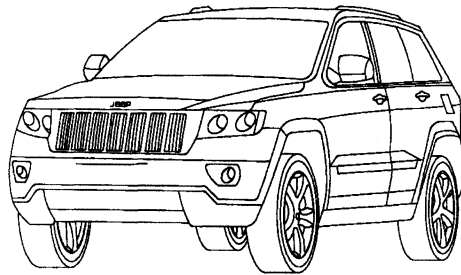

|                                 |  |           |
|---------------------------------|--|-----------|
| <b>DW01840<sup>b,c,e</sup></b>  | Windshield (Solar) (W/Third Visor Frit, Rain Sensor) |           |
| <b>DW01839<sup>b,c</sup></b>    | Windshield (Solar) (W/Third Visor Frit)              |           |
| <b>DD11815-16</b>               | Door F/R-L (Solar) (Laminated)                       | 24.5x36.0 |
| <b>DD11813-14</b>               | Door F/R-L (Solar)                                   | 24.5x36.0 |
| <b>DD11817-18</b>               | Door R/R-L (Solar)                                   |           |
| <b>DQ11819-20<sup>a,d</sup></b> | Quarter R-L (Encap)(Solar)                           |           |
| <b>DB11821<sup>d</sup></b>      | Back Window (Heated)(1 Holes)(Solar)                 |           |

- <sup>a</sup> GTY is Export Only
- <sup>b</sup> Urethane,Dam,Primer - 2 Tubes
- <sup>c</sup> Fast-Cure Urethane/Dam/Primer - Quantity 2
- <sup>d</sup> Urethane,Dam,Primer - 1.5 Tubes
- <sup>e</sup> Rain Sensor Kit

**Grand Cherokee 4 Door Utility**..... 2006-2010

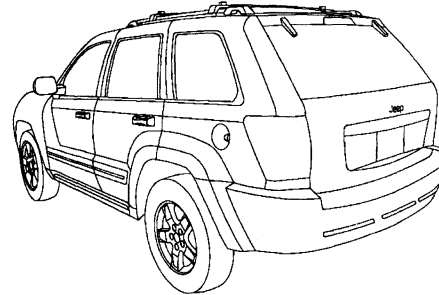

|                                |   |           |
|--------------------------------|---|-----------|
| <b>DW01705<sup>a,b,c</sup></b> | Windshield (Rain Sensor) (From 11/06/2006) (07-10)              | 31.1x62.0 |
| <b>DW01704<sup>a,b,c</sup></b> | Windshield (From 11/06/2006) (07-10)                            | 31.1x62.0 |
| <b>DW01592<sup>b,c</sup></b>   | Windshield (Rain Sensor) (To 11/06/2006) (06-07)                | 31.0x62.0 |
| <b>DW01591<sup>b,c</sup></b>   | Windshield (To 11/06/2006) (06-07)                              | 31.0x62.0 |
| <b>DD11131-32</b>              | Door F/R-L  | 17.0x30.1 |
| <b>DD11085-86</b>              | Door F/R-L (Laminated, Secure Shield Logo) (From 09/05/2005)    | 17.0x30.1 |
| <b>DD10849-50</b>              | Door F/R-L (Laminated, Secure Shield Logo) (To 09/05/2005) (06) | 17.0x30.1 |
| <b>DD10789-90</b>              | Door R/R-L (Solar)  | 16.5x27.6 |
| <b>DQ11049-50<sup>d</sup></b>  | Quarter R-L (Encap)(Solar) (Brushed Aluminum Frame)             | 16.1x26.0 |
| <b>DQ10793-94<sup>d</sup></b>  | Quarter R-L (Encap)(Solar) (Chrome Frame)                       | 16.1x26.0 |
| <b>DQ10791-92<sup>d</sup></b>  | Quarter R-L (Encap)(Solar) (Black Frame)                        | 16.1x26.0 |
| <b>DB10795</b>                 | Back Window (Heated)(Solar)                                     | 20.1x52.8 |

- <sup>a</sup> Per Chrysler, No Upper Moulding Required
- <sup>b</sup> Urethane,Dam,Primer - 2 Tubes
- <sup>c</sup> Fast-Cure Urethane/Dam/Primer - Quantity 2
- <sup>d</sup> Urethane,Dam,Primer - 1 Tube

**Liberty 4 Door Utility**..... 2008-2011

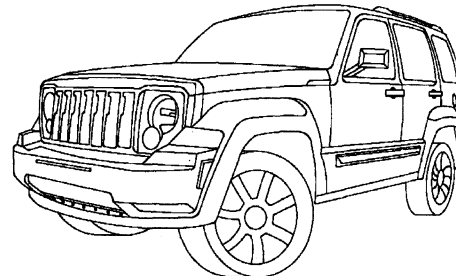

|                               |  |           |
|-------------------------------|--|-----------|
| <b>DW01724<sup>a,b</sup></b>  | Windshield (W/Third Visor Frit, Rain Sensor) | 26.0x60.5 |
| <b>DW01723<sup>a,b</sup></b>  | Windshield (W/Third Visor Frit)              | 26.0x60.5 |
| <b>DD11434-35</b>             | Door F/R-L (1 Holes)                         | 22.8x26.0 |
| <b>DD11438-39</b>             | Door R/R-L (1 Holes)(Solar)                  | 22.3x22.8 |
| <b>DD11436-37</b>             | Door R/R-L (1 Holes)                         | 22.3x22.8 |
| <b>DQ11446-47<sup>c</sup></b> | Quarter R-L (Solar)                          | 18.0x23.0 |
| <b>DQ11444-45<sup>c</sup></b> | Quarter R-L                                  | 18.0x23.0 |
| <b>DV11442-43</b>             | Vent R/R-L (Solar)                           | 5.5x17.0  |
| <b>DV11440-41</b>             | Vent R/R-L                                   | 5.5x17.0  |
| <b>DB11449</b>                | Back Window (Heated)(6 Holes)(Solar)         | 17.3x54.5 |
| <b>DB11448</b>                | Back Window (Heated)(6 Holes)                | 17.3x54.5 |

- <sup>a</sup> Urethane,Dam,Primer - 2 Tubes
- <sup>b</sup> Fast-Cure Urethane/Dam/Primer - Quantity 2
- <sup>c</sup> Urethane,Dam,Primer - 1 Tube

**Liberty 4 Door Utility ..... 2006-2007**

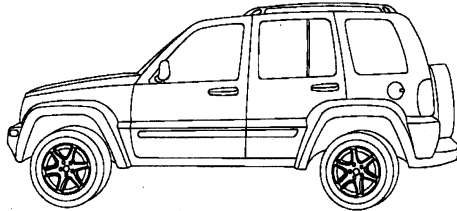

|   |           |
|---|-----------|
| DW01678 <sup>a e f</sup> Windshield (W/Third Visor Frit) (07) .....         | 25.7x60.3 |
| DW01511 <sup>a e f</sup> Windshield (W/Third Visor Frit) (06) .....         | 25.7x60.3 |
| DD11118-19 <sup>b</sup> Door F/R-L (1 Holes) (From 03/01/2006) .....        | 22.0x27.0 |
| DD09984-85 Door F/R-L .....   | 22.0x27.0 |
| DD11122-23 <sup>d</sup> Door R/R-L (1 Holes)(Solar) (From 03/01/2006) ..... | 17.4x24.2 |
| DD11120-21 <sup>c</sup> Door R/R-L (1 Holes) (From 03/01/2006) .....        | 17.4x24.2 |
| DD10725-26 Door R/R-L (Solar) .....   | 17.4x24.2 |
| DD09986-87 Door R/R-L .....   | 17.4x24.2 |
| DQ10729-30 <sup>e</sup> Quarter R-L (Solar) .....                           | 18.5x19.9 |
| DQ10069 <sup>g</sup> Quarter R (Ant)(Solar) (Export Only) .....             | 18.5x19.9 |
| DQ09990 <sup>g</sup> Quarter R (Ant) (Export Only) .....                    | 18.5x19.9 |
| DQ09988-89 <sup>g</sup> Quarter R-L .....                                   | 18.5x19.9 |
| DV11038-39 Vent R/R-L (Solar) .....   | 9.6x21.4  |
| DV11036-37 Vent R/R-L .....   | 9.6x21.4  |
| DB10571 Back Window (Encap)(Heated)(2 Holes)(Solar) .....                   | 18.7x54.0 |
| DB10570 Back Window (Encap)(Heated)(2 Holes) .....                          | 18.7x54.0 |

<sup>a</sup> Per Chrysler, No Upper Moulding Required  
<sup>b</sup> No Longer Produced, Use DD09984-5GTY  
<sup>c</sup> No Longer Produced, Use DD09986-7GTY  
<sup>d</sup> No Longer Produced, Use DD10725-6YPY  
<sup>e</sup> Urethane,Dam,Primer - 2 Tubes  
<sup>f</sup> Fast-Cure Urethane/Dam/Primer - Quantity 2  
<sup>g</sup> Urethane,Dam,Primer - 1 Tube

**Patriot 4 Door Utility ..... 2007-2011**

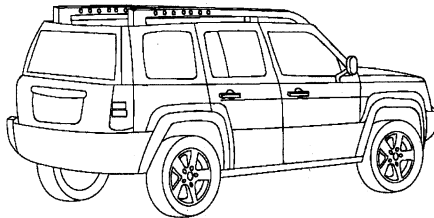

|   |           |
|---|-----------|
| DW01682 <sup>a b</sup> Windshield (Solar) (W/Third Visor Frit) .....    | 26.9x56.7 |
| DD11300-01 Door F/R-L (2 Holes)(Solar) .....                            | 23.5x34.8 |
| DD11302-03 Door R/R-L (1 Holes)(Solar) .....                            | 19.8x21.3 |
| DQ11306-07 <sup>d</sup> Quarter R-L (Solar) .....                       | 16.0x22.5 |
| DV11304-05 Vent R/R-L (Solar) .....                                     | 7.4x16.3  |
| DB11308 <sup>c</sup> Back Window (Heated)(1 Holes)(Solar) (W/Wiper) ... | 15.5x50.3 |

<sup>a</sup> Urethane,Dam,Primer - 2 Tubes  
<sup>b</sup> Fast-Cure Urethane/Dam/Primer - Quantity 2  
<sup>c</sup> Urethane,Dam,Primer - 1.5 Tubes  
<sup>d</sup> Urethane,Dam,Primer - 1 Tube

**TJ 2 Door Utility ..... 2006 (CANADA Only)**

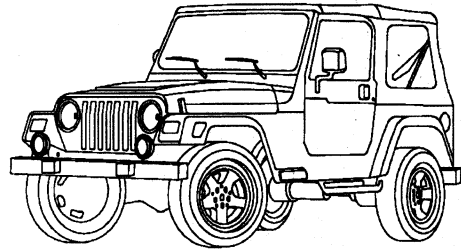

|   |           |
|---|-----------|
| DW01408 <sup>a b</sup> Windshield (Solar) .....               | 17.6x53.5 |
| DW01407 <sup>a b</sup> Windshield .....                       | 17.6x53.5 |
| DD09069-70 Door F/R-L (2 Holes) .....                         | 20.0x28.0 |
| DQ10722-23 <sup>a</sup> Quarter R-L (Solar) (103.4" WB) ..... | 18.0x41.0 |
| DQ09075-76 <sup>a</sup> Quarter R-L (93.4" WB) .....          | 22.0x33.0 |
| DQ09071-72 <sup>a</sup> Quarter R-L (Solar) (93.4" WB) .....  | 22.5x32.5 |
| DB10326 Back Window (Encap)(Heated)(6 Holes)(Solar) .....     | 24.6x49.5 |
| DB10325 Back Window (Encap)(Heated)(6 Holes) .....            | 24.6x49.5 |

<sup>a</sup> Urethane,Dam,Primer - 1.5 Tubes  
<sup>b</sup> Fast-Cure Urethane/Dam/Primer - Quantity 1.5

**Wrangler 2 Door Utility ..... 2011**

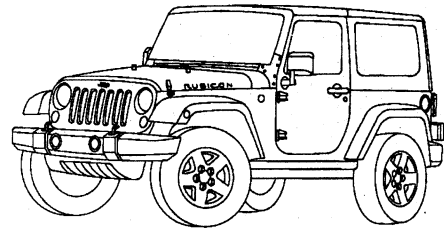

|   |           |
|---|-----------|
| DW01881 <sup>b c d</sup> Windshield (Solar) (Jeep Grille in 3rd Visor Frit) ..... | 18.6x54.7 |
| DW01668 <sup>a c d</sup> Windshield (Solar) .....                                 | 18.6x54.7 |
| DD11208-09 Door F/R-L (1 Holes) .....   | 21.4x27.6 |
| DQ11884-85 <sup>c</sup> Quarter R-L (Solar) .....                                 |           |
| DQ11882-83 <sup>c</sup> Quarter R-L .....   |           |
| DB11891 Back Window (Encap)(Heated)(Solar) .....                                  |           |
| DB11890 Back Window (Encap)(Heated) .....   |           |

<sup>a</sup> Not On Production Vehicles  
<sup>b</sup> On Production Vehicles  
<sup>c</sup> Urethane,Dam,Primer - 1.5 Tubes  
<sup>d</sup> Fast-Cure Urethane/Dam/Primer - Quantity 1.5

**Wrangler 2 Door Utility ..... 2007-2010**

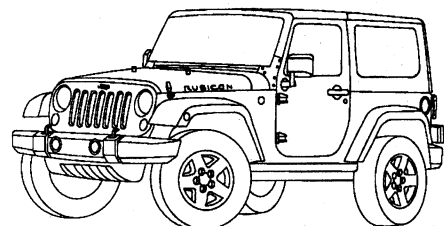

|   |           |
|---|-----------|
| DW01668 <sup>a b</sup> Windshield (Solar) .....           | 18.6x54.7 |
| DD11208-09 Door F/R-L (1 Holes) .....                     | 21.4x27.6 |
| DQ11298-99 <sup>c</sup> Quarter R-L .....                 | 16.6x34.6 |
| DQ11217-18 <sup>c</sup> Quarter R-L (Solar) .....         | 16.6x34.6 |
| DB11297 Back Window (Encap)(Heated)(6 Holes) .....        | 20.6x42.0 |
| DB11216 Back Window (Encap)(Heated)(6 Holes)(Solar) ..... | 20.6x42.0 |

**Wrangler (cont.)**

<sup>a</sup> Urethane,Dam,Primer - 1.5 Tubes  
<sup>b</sup> Fast-Cure Urethane/Dam/Primer - Quantity 1.5  
<sup>c</sup> Urethane,Dam,Primer - 1 Tube

**Wrangler 2 Door Utility..... 2006 (USA Only)**

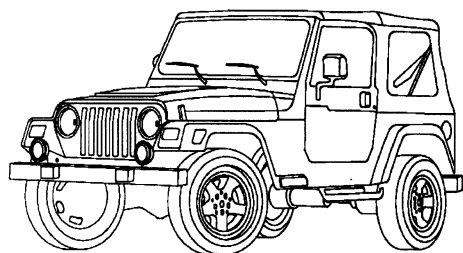

|   |           |
|---|-----------|
| DW01408 <sup>a,b</sup> Windshield (Solar) .....               | 17.6x53.5 |
| DW01407 <sup>a,b</sup> Windshield .....                       | 17.6x53.5 |
| DD09069-70 Door F/R-L (2 Holes) .....                         | 20.0x28.0 |
| DQ10722-23 <sup>a</sup> Quarter R-L (Solar) (103.4" WB) ..... | 18.0x41.0 |
| DQ09075-76 <sup>a</sup> Quarter R-L (93.4" WB) .....          | 22.0x33.0 |
| DQ09071-72 <sup>a</sup> Quarter R-L (Solar) (93.4" WB) .....  | 22.5x32.5 |
| DB10326 Back Window (Encap)(Heated)(6 Holes)(Solar) .....     | 24.6x49.5 |
| DB10325 Back Window (Encap)(Heated)(6 Holes) .....            | 24.6x49.5 |

<sup>a</sup> Urethane,Dam,Primer - 1.5 Tubes  
<sup>b</sup> Fast-Cure Urethane/Dam/Primer - Quantity 1.5

**Wrangler 4 Door Utility..... 2011**

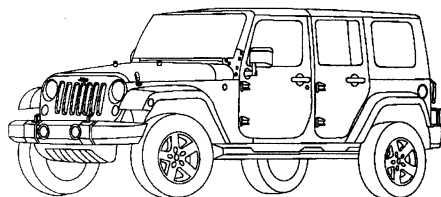

|   |           |
|---|-----------|
| DW01881 <sup>b,c,d</sup> Windshield (Solar) (Jeep Grille in 3rd Visor Frit) ..... | 18.6x54.7 |
| DW01668 <sup>a,c,d</sup> Windshield (Solar) .....                                 | 18.6x54.7 |
| DD11208-09 Door F/R-L (1 Holes) .....   | 21.4x27.6 |
| DD11291-92 Door R/R-L (1 Holes) .....   | 18.7x20.7 |
| DD11210-11 Door R/R-L (1 Holes)(Solar) .....                                      | 18.7x20.7 |
| DQ11888-89 <sup>c</sup> Quarter R-L (Solar) .....                                 |           |
| DQ11886-87 <sup>c</sup> Quarter R-L .....   |           |
| DV11566-67 Vent R/R-L (Solar) .....   | 5.4x16.1  |
| DV11564-65 Vent R/R-L .....   | 5.4x16.1  |
| DB11891 Back Window (Encap)(Heated)(Solar) .....                                  |           |
| DB11890 Back Window (Encap)(Heated) .....   |           |

<sup>a</sup> Not On Production Vehicles  
<sup>b</sup> On Production Vehicles  
<sup>c</sup> Urethane,Dam,Primer - 1.5 Tubes  
<sup>d</sup> Fast-Cure Urethane/Dam/Primer - Quantity 1.5

**Wrangler 4 Door Utility..... 2007-2010**

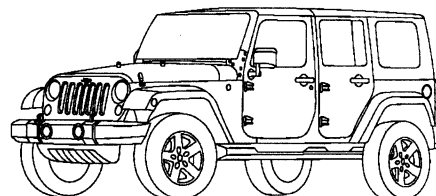

|   |           |
|---|-----------|
| DW01668 <sup>a,b</sup> Windshield (Solar) .....               | 18.6x54.7 |
| DD11208-09 Door F/R-L (1 Holes) .....                         | 21.4x27.6 |
| DD11291-92 Door R/R-L (1 Holes) .....                         | 18.7x20.7 |
| DD11210-11 Door R/R-L (1 Holes)(Solar) .....                  | 18.7x20.7 |
| DQ11295-96 <sup>c</sup> Quarter R-L .....                     | 16.6x23.6 |
| DQ11214-15 <sup>c</sup> Quarter R-L (Solar) .....             | 16.6x23.6 |
| DV11566-67 Vent R/R-L (Solar) (From 03/03/2008) (08-10) ..... | 5.4x16.1  |
| DV11564-65 Vent R/R-L (From 03/03/2008) (08-10) .....         | 5.4x16.1  |
| DV11293-94 Vent R/R-L (To 03/03/2008) (07-08) .....           | 5.4x16.1  |
| DV11212-13 Vent R/R-L (Solar) (To 03/03/2008) (07-08) .....   | 5.4x16.1  |
| DB11297 Back Window (Encap)(Heated)(6 Holes) .....            | 20.6x42.0 |
| DB11216 Back Window (Encap)(Heated)(6 Holes)(Solar) .....     | 20.6x42.0 |

<sup>a</sup> Urethane,Dam,Primer - 1.5 Tubes  
<sup>b</sup> Fast-Cure Urethane/Dam/Primer - Quantity 1.5  
<sup>c</sup> Urethane,Dam,Primer - 1 Tube

**Amanti 4 Door Sedan..... 2007-2009**

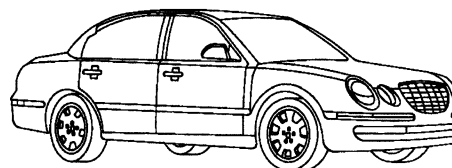

|   |           |
|---|-----------|
| FW02862 <sup>a,b</sup> Windshield (Heated)(Solar) (Heated Wiper Park Area) .....                        | 34.5x59.5 |
| FW02850 <sup>a,b</sup> Windshield (Heated)(Solar) (Electrochromic Mirror, Heated Wiper Park Area) ..... | 34.5x59.5 |
| FD23682-83 Door F/R-L (Solar) (Hydrophobic Coating) .....   | 19.0x30.0 |
| FD23680-81 Door F/R-L (2 Holes)(Solar) .....  | 19.0x30.5 |
| FD23684-85 Door R/R-L (Solar) .....   | 19.0x25.5 |
| FV23686-87 Vent R/R-L (Solar) .....   | 6.5x14.0  |
| FB23688 <sup>c</sup> Back Window (Ant)(Encap)(Heated)(Solar) .....                                      | 22.0x52.0 |

<sup>a</sup> Urethane,Dam,Primer - 2 Tubes  
<sup>b</sup> Fast-Cure Urethane/Dam/Primer - Quantity 2  
<sup>c</sup> Urethane,Dam,Primer - 1.5 Tubes

**Amanti 4 Door Sedan..... 2006**

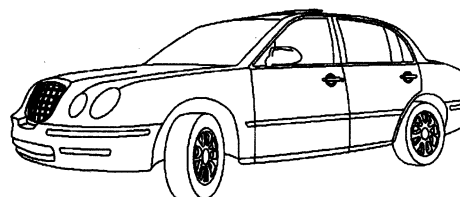

|   |           |
|---|-----------|
| FW02482 <sup>a,b</sup> Windshield (Heated)(Solar) (Heated Wiper Park Area, Rain Sensor) ..... | 34.5x59.5 |
| FW02442 <sup>a,b</sup> Windshield (Heated)(Solar) (Heated Wiper Park Area) .....              | 34.5x59.5 |
| FD22163-64 Door F/R-L (Solar) .....   | 19.0x30.5 |
| FD22165-66 Door R/R-L (Solar) .....   | 19.0x26.5 |
| FV22167-68 Vent R/R-L (Solar) .....   | 6.5x14.5  |

**Amanti (cont.)**

**FB22169<sup>c</sup>** Back Window (Ant)(Heated)(Solar) ..... **21.8x51.8**  
<sup>a</sup> Urethane,Dam,Primer - 2 Tubes  
<sup>b</sup> Fast-Cure Urethane/Dam/Primer - Quantity 2  
<sup>c</sup> Urethane,Dam,Primer - 1.5 Tubes

**Borrego 4 Door Utility ..... 2009-2011**

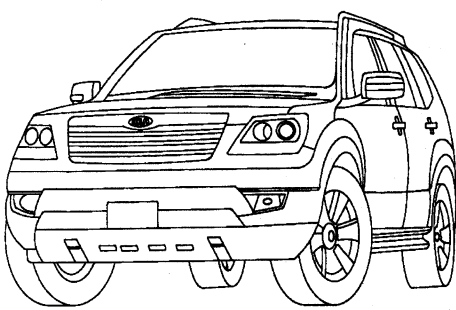

**FW03150<sup>a b</sup>** Windshield (Heated) (Electrochromic Mirror, W/Third Visor Frit, Heated Wiper Park Area) ..... **36.0x63.0**  
**FW03149<sup>a b</sup>** Windshield (Heated) (W/Third Visor Frit, Heated Wiper Park Area) ..... **36.0x63.0**  
**FW03148<sup>a b</sup>** Windshield (Electrochromic Mirror, W/Third Visor Frit) ..... **36.0x63.0**  
**FW03006<sup>a b</sup>** Windshield (W/Third Visor Frit) ..... **36.0x63.0**  
**FD24050-51** Door F/R-L ..... **22.0x35.0**  
**FD24052-53** Door R/R-L (Solar) ..... **21.0x31.0**  
**FQ24056<sup>d</sup>** Quarter R (Ant)(Encap)(Solar) ..... **18.0x26.0**  
**FQ24054-55<sup>d</sup>** Quarter R-L (Encap)(Solar) ..... **18.0x26.0**  
**FB24057<sup>c</sup>** Back Window (Heated)(1 Holes)(Solar) ..... **19.0x55.5**  
<sup>a</sup> Urethane,Dam,Primer - 2 Tubes  
<sup>b</sup> Fast-Cure Urethane/Dam/Primer - Quantity 2  
<sup>c</sup> Urethane,Dam,Primer - 1.5 Tubes  
<sup>d</sup> Urethane,Dam,Primer - 1 Tube

**Forte 4 Door Sedan ..... 2010-2011**

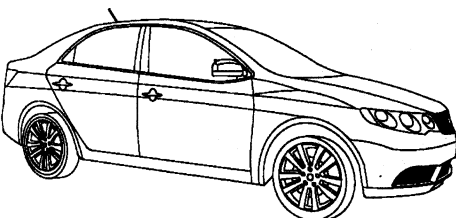

**FW03135<sup>a b</sup>** Windshield (Heated)(Solar) (Electrochromic Mirror, W/Third Visor Frit, Heated Wiper Park Area) ..... **38.0x57.5**  
**FW03134<sup>a b</sup>** Windshield (Solar) (Electrochromic Mirror, W/Third Visor Frit) ..... **38.0x57.5**  
**FW03133<sup>a b</sup>** Windshield (Heated) (Electrochromic Mirror, W/Third Visor Frit, Heated Wiper Park Area) ..... **38.0x57.5**  
**FW03132<sup>a b</sup>** Windshield (Electrochromic Mirror, W/Third Visor Frit) ..... **38.0x57.5**  
**FD24385-86** Door F/R-L (Solar) ..... **20.1x37.3**  
**FD24383-84** Door F/R-L ..... **20.1x37.3**  
**FD24389-90** Door R/R-L (Solar) ..... **18.6x30.5**  
**FD24387-88** Door R/R-L ..... **18.6x30.5**  
**FB24392<sup>c</sup>** Back Window (Heated)(Solar) ..... **29.0x46.0**  
**FB24391<sup>c</sup>** Back Window (Heated) ..... **29.0x46.0**  
<sup>a</sup> Urethane,Dam,Primer - 2 Tubes  
<sup>b</sup> Fast-Cure Urethane/Dam/Primer - Quantity 2  
<sup>c</sup> Urethane,Dam,Primer - 1.5 Tubes

**Forte Koup 2 Door Coupe ..... 2010-2011**

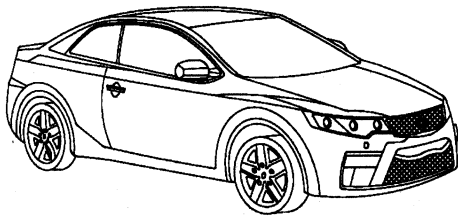

**FW03189<sup>a b</sup>** Windshield (Heated)(Solar) (Electrochromic Mirror, W/Third Visor Frit, Heated Wiper Park Area) ..... **37.5x56.5**  
**FW03188<sup>a b</sup>** Windshield (Solar) (Electrochromic Mirror, W/Third Visor Frit) ..... **37.5x56.5**  
**FD24546-47** Door F/R-L (Solar) ..... **18.0x41.0**  
**FQ24548-49<sup>d</sup>** Quarter R-L (Encap)(Solar) ..... **14.0x27.0**  
**FB24551<sup>c</sup>** Back Window (Heated)(Solar) ..... **33.0x46.0**  
<sup>a</sup> Urethane,Dam,Primer - 2 Tubes  
<sup>b</sup> Fast-Cure Urethane/Dam/Primer - Quantity 2  
<sup>c</sup> Urethane,Dam,Primer - 1.5 Tubes  
<sup>d</sup> Foam Core Butyl Tape - Quantity 1

**Magentis 4 Door Sedan ..... 2007-2010 (CANADA Only)**

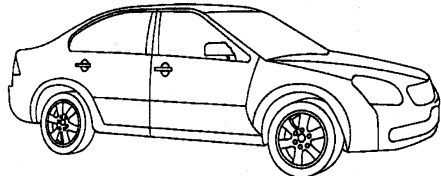

**FW03068<sup>a b c</sup>** Windshield (Heated)(Solar) (Electrochromic Mirror, W/Third Visor Frit, Heated Wiper Park Area, Rain Sensor) (09-10) ..... **35.2x58.7**  
**FW03067<sup>a b</sup>** Windshield (Heated)(Solar) (W/Third Visor Frit, Heated Wiper Park Area) (09-10) ..... **35.2x58.7**  
**FW02847<sup>a b</sup>** Windshield (Heated)(Solar) (Electrochromic Mirror, W/Third Visor Frit, Heated Wiper Park Area, Rain Sensor) (07-08) ..... **36.7x58.7**  
**FW02706<sup>a b</sup>** Windshield (Solar) (Electrochromic Mirror, W/Third Visor Frit) (07-08) ..... **36.7x58.7**  
**FW02705<sup>a b</sup>** Windshield (Electrochromic Mirror, W/Third Visor Frit) (07-08) ..... **36.7x58.7**  
**FW02704<sup>a b</sup>** Windshield (Solar) (W/Third Visor Frit) (07-08) ..... **36.7x58.7**  
**FW02646<sup>a b</sup>** Windshield (W/Third Visor Frit) (07-08) ..... **36.7x58.7**  
**FD23026-27** Door F/R-L (2 Holes) ..... **20.5x35.0**  
**FD23028-29** Door R/R-L (2 Holes) ..... **19.3x26.3**  
**FV23030-31** Vent R/R-L ..... **10.0x12.3**  
**FB24305<sup>a</sup>** Back Window (Heated)(Solar) ..... **32.5x50.3**  
**FB23032<sup>a</sup>** Back Window (Ant)(Heated)(Solar) ..... **32.5x50.3**  
<sup>a</sup> Urethane,Dam,Primer - 2 Tubes  
<sup>b</sup> Fast-Cure Urethane/Dam/Primer - Quantity 2  
<sup>c</sup> Rain Sensor Kit

**Magentis 4 Door Sedan ..... 2006**  
(CANADA Only)

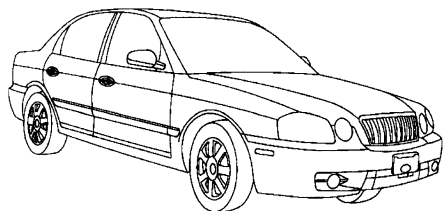

|   |                  |
|---|------------------|
| <b>FW02114<sup>a b</sup></b> Windshield .....         | <b>34.3x60.6</b> |
| <b>FD21898-99</b> Door F/R-L .....                    | <b>26.0x34.0</b> |
| <b>FD21919-20</b> Door R/R-L .....                    | <b>23.3x30.3</b> |
| <b>FB21255<sup>c</sup></b> Back Window (Heated) ..... | <b>29.0x51.0</b> |

<sup>a</sup> Urethane,Dam,Primer - 2 Tubes  
<sup>b</sup> Fast-Cure Urethane/Dam/Primer - Quantity 2  
<sup>c</sup> Urethane,Dam,Primer - 1.5 Tubes

**Optima 4 Door Sedan ..... 2007-2010**  
**Optima (NEW) 4 Door Sedan ..... 2006**  
(USA Only)

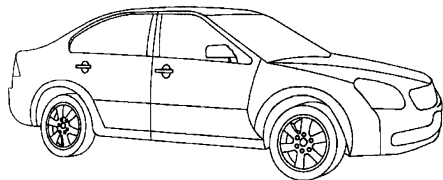

|   |                  |
|---|------------------|
| <b>FW03058<sup>b c</sup></b> Windshield (Solar) (Electrochromic Mirror, W/Third Visor Frit) (09-10) .....   | <b>35.2x58.7</b> |
| <b>FW03057<sup>b c</sup></b> Windshield (Solar) (W/Third Visor Frit) (09-10) .....                          | <b>35.2x58.7</b> |
| <b>FW02706<sup>a b c</sup></b> Windshield (Solar) (Electrochromic Mirror, W/Third Visor Frit) (06-08) ..... | <b>36.7x58.7</b> |
| <b>FW02705<sup>a b c</sup></b> Windshield (Electrochromic Mirror, W/Third Visor Frit) (06-08) .....         | <b>36.7x58.7</b> |
| <b>FW02704<sup>a b c</sup></b> Windshield (Solar) (W/Third Visor Frit) (06-08) .....                        | <b>36.7x58.7</b> |
| <b>FW02646<sup>a b c</sup></b> Windshield (W/Third Visor Frit) (06-08) .....                                | <b>36.7x58.7</b> |
| <b>FD23026-27</b> Door F/R-L (2 Holes) (06-10) .....  | <b>20.5x35.0</b> |
| <b>FD23028-29</b> Door R/R-L (2 Holes) (06-10) .....  | <b>19.3x26.3</b> |
| <b>FV23030-31</b> Vent R/R-L (06-10) .....  | <b>10.0x12.3</b> |
| <b>FB24305<sup>b</sup></b> Back Window (Heated)(Solar) (06-10) .....  | <b>32.5x50.3</b> |
| <b>FB23032<sup>b</sup></b> Back Window (Ant)(Heated)(Solar) (06-10) .....                                   | <b>32.5x50.3</b> |

<sup>a</sup> The 5th Digit of the VIN is "E"  
<sup>b</sup> Urethane,Dam,Primer - 2 Tubes  
<sup>c</sup> Fast-Cure Urethane/Dam/Primer - Quantity 2

**Optima 4 Door Sedan ..... 2006**  
(USA Only)

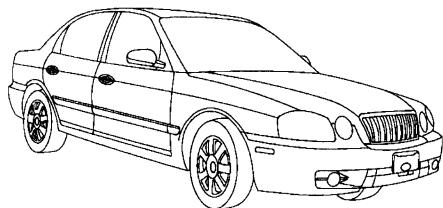

|  |                  |
|--|------------------|
| <b>FW02114<sup>a b c</sup></b> Windshield .....            | <b>34.3x60.6</b> |
| <b>FD21898-99</b> Door F/R-L .....                         | <b>26.0x34.0</b> |
| <b>FD21919-20</b> Door R/R-L .....                         | <b>23.3x30.3</b> |
| <b>FB23195<sup>d</sup></b> Back Window (Ant)(Heated) ..... | <b>29.0x51.0</b> |

**Optima (cont.)**

|   |                  |
|---|------------------|
| <b>FB21255<sup>d</sup></b> Back Window (Heated) ..... | <b>29.0x51.0</b> |
|---|------------------|

<sup>a</sup> The 5th Digit of the VIN is "D"  
<sup>b</sup> Urethane,Dam,Primer - 2 Tubes  
<sup>c</sup> Fast-Cure Urethane/Dam/Primer - Quantity 2  
<sup>d</sup> Urethane,Dam,Primer - 1.5 Tubes

**Rio 4 Door Sedan ..... 2006-2011**

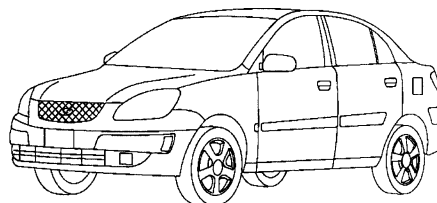

|   |                  |
|---|------------------|
| <b>FW03226<sup>a b</sup></b> Windshield (10-11) ..... | <b>36.2x54.5</b> |
| <b>FW02605<sup>a b</sup></b> Windshield (06-09) ..... | <b>36.2x54.5</b> |
| <b>FD22825-26</b> Door F/R-L (2 Holes) .....          | <b>18.0x33.0</b> |
| <b>FD22827-28</b> Door R/R-L (2 Holes) .....          | <b>19.5x25.3</b> |
| <b>FV22829-30</b> Vent R/R-L .....                    | <b>8.8x12.8</b>  |
| <b>FB22831<sup>c</sup></b> Back Window (Heated) ..... | <b>26.0x48.3</b> |

<sup>a</sup> Urethane,Dam,Primer - 2 Tubes  
<sup>b</sup> Fast-Cure Urethane/Dam/Primer - Quantity 2  
<sup>c</sup> Urethane,Dam,Primer - 1.5 Tubes

**Rio5 4 Door Hatchback ..... 2006-2011**

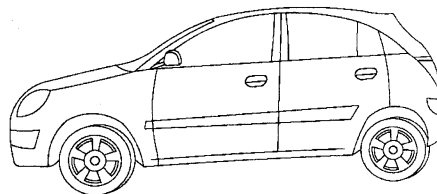

|   |                  |
|---|------------------|
| <b>FW03226<sup>a b</sup></b> Windshield (10-11) ..... | <b>36.2x54.5</b> |
| <b>FW02605<sup>a b</sup></b> Windshield (06-09) ..... | <b>36.2x54.5</b> |
| <b>FD22825-26</b> Door F/R-L (2 Holes) .....          | <b>18.0x33.0</b> |
| <b>FD22832-33</b> Door R/R-L (2 Holes) .....          | <b>19.5x24.5</b> |
| <b>FV22834-35</b> Vent R/R-L .....                    | <b>8.8x11.5</b>  |
| <b>FB22836<sup>c</sup></b> Back Window (Heated) ..... | <b>19.5x53.0</b> |

<sup>a</sup> Urethane,Dam,Primer - 2 Tubes  
<sup>b</sup> Fast-Cure Urethane/Dam/Primer - Quantity 2  
<sup>c</sup> Urethane,Dam,Primer - 1.5 Tubes

**Rondo 4 Door Utility ..... 2007-2010**

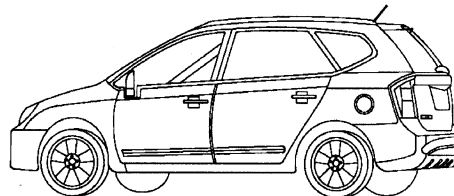

|  |                  |
|--|------------------|
| <b>FW03334<sup>a b</sup></b> Windshield (Heated) (Heated Wiper Park Area) (10) ..              | <b>37.0x58.9</b> |
| <b>FW02835<sup>a b</sup></b> Windshield (Heated)(Solar) (Heated Wiper Park Area)               | <b>37.0x58.9</b> |
| <b>FW02834<sup>a b</sup></b> Windshield (Solar) .....  | <b>37.0x58.9</b> |
| <b>FW02820<sup>a b d</sup></b> Windshield (Heated) (Heated Wiper Park Area, Rain Sensor) ..... | <b>37.0x58.9</b> |



**Rondo (cont.)**

|                         |  |           |
|-------------------------|--|-----------|
| FW02819 <sup>a b</sup>  | Windshield (Heated) (Heated Wiper Park Area) (07-09) | 37.0x58.9 |
| FW02818 <sup>a b</sup>  | Windshield   | 37.0x58.9 |
| FD23520-21              | Door F/R-L   | 25.0x33.8 |
| FD23522-23              | Door R/R-L (1 Holes)                                 | 23.5x24.8 |
| FQ23526-27 <sup>e</sup> | Quarter R-L (Encap)                                  | 18.5x22.1 |
| FV23518-19 <sup>e</sup> | Vent F/R-L (Encap)                                   | 10.5x11.4 |
| FV23524-25              | Vent R/R-L   | 15.0x19.8 |
| FB23528 <sup>c</sup>    | Back Window (Heated)(1 Holes)(Solar)                 | 22.0x50.3 |

<sup>a</sup> Urethane,Dam,Primer - 2 Tubes  
<sup>b</sup> Fast-Cure Urethane/Dam/Primer - Quantity 2  
<sup>c</sup> Urethane,Dam,Primer - 1.5 Tubes  
<sup>d</sup> Rain Sensor Kit  
<sup>e</sup> Urethane,Dam,Primer - 1 Tube

**Sedona Mini Van..... 2006-2011**

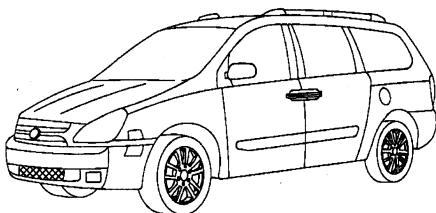

|                          |   |           |
|--------------------------|---|-----------|
| FW02642 <sup>a b c</sup> | Windshield (Heated)(Solar) (Electrochromic Mirror, Heated Wiper Park Area, Rain Sensor) | 42.0x65.0 |
| FW02641 <sup>a b c</sup> | Windshield (Heated)(Solar) (Heated Wiper Park Area, Rain Sensor)                        | 42.0x65.0 |
| FW02640 <sup>a b</sup>   | Windshield (Heated)(Solar) (Heated Wiper Park Area)                                     | 42.0x65.0 |
| FW02639 <sup>a b</sup>   | Windshield (Heated)(Solar) (Electrochromic Mirror, Heated Wiper Park Area)              | 42.0x65.0 |
| FW02638 <sup>a b</sup>   | Windshield (Heated) (Heated Wiper Park Area)  | 42.0x65.0 |
| FD23006-07               | Door F/R-L (Solar)  | 22.0x33.0 |
| FD23004-05               | Door F/R-L  | 22.0x33.0 |
| FD23008-09               | Door R/R-L (Solar) (Sliding Cargo Door)   | 23.3x33.0 |
| FQ23010-11               | Quarter R-L (Ant)(1 Holes)(Solar)   | 20.5x40.5 |
| FB23012 <sup>a</sup>     | Back Window (Heated)(1 Holes)(Solar) (W/Wiper)  | 23.8x57.8 |

<sup>a</sup> Urethane,Dam,Primer - 2 Tubes  
<sup>b</sup> Fast-Cure Urethane/Dam/Primer - Quantity 2  
<sup>c</sup> Rain Sensor Kit

**Sorento 4 Door Utility..... 2011**

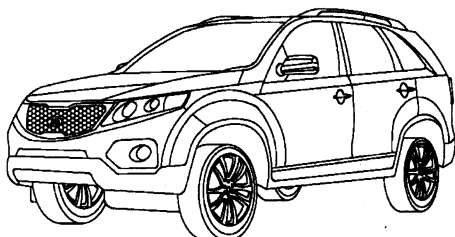

|                         |   |           |
|-------------------------|---|-----------|
| FW03171 <sup>a b</sup>  | Windshield (Heated)(Solar) (W/Third Visor Frit, Heated Wiper Park Area) | 36.5x58.0 |
| FW03170 <sup>a b</sup>  | Windshield (Solar) (W/Third Visor Frit)                                 | 36.5x58.0 |
| FD24475-76              | Door F/R-L (Solar)  | 19.0x30.5 |
| FD24477-78              | Door R/R-L (Solar)  | 19.0x28.0 |
| FQ24479-80 <sup>d</sup> | Quarter R-L (Encap)(Solar)  | 18.0x20.0 |
| FB24481 <sup>c</sup>    | Back Window (Heated)(1 Holes)(Solar)                                    | 17.5x62.0 |

<sup>a</sup> Urethane,Dam,Primer - 2 Tubes  
<sup>b</sup> Fast-Cure Urethane/Dam/Primer - Quantity 2  
<sup>c</sup> Urethane,Dam,Primer - 1.5 Tubes

**Sorento (cont.)**

<sup>d</sup> Urethane,Dam,Primer - 1 Tube

**Sorento 4 Door Utility..... 2006-2010**

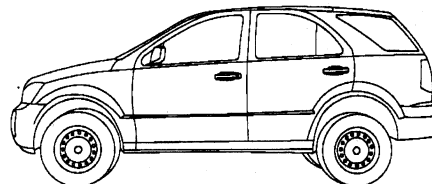

|                         |  |           |
|-------------------------|--|-----------|
| FW02361 <sup>a b</sup>  | Windshield (Heated)(Solar) (W/Third Visor Frit, Heated Wiper Park Area)                        | 34.1x58.3 |
| FW02360 <sup>a b</sup>  | Windshield (Heated)(Solar) (Electrochromic Mirror, W/Third Visor Frit, Heated Wiper Park Area) | 34.1x58.3 |
| FD21831-32              | Door F/R-L (2 Holes)(Solar)  | 22.0x31.0 |
| FD21833-34              | Door R/R-L (2 Holes)(Solar)  | 22.5x23.5 |
| FQ21837-38 <sup>d</sup> | Quarter R-L (Encap)(Solar)   | 15.5x30.4 |
| FV21835-36              | Vent R/R-L (Solar)   | 10.3x13.0 |
| FB21839 <sup>c</sup>    | Back Window (Heated)(6 Holes)(Solar)   | 19.8x54.6 |

<sup>a</sup> Urethane,Dam,Primer - 2 Tubes  
<sup>b</sup> Fast-Cure Urethane/Dam/Primer - Quantity 2  
<sup>c</sup> Foam Core Butyl Tape - Quantity 1.5  
<sup>d</sup> Foam Core Butyl Tape - Quantity 1

**Soul 4 Door Hatchback..... 2010-2011**

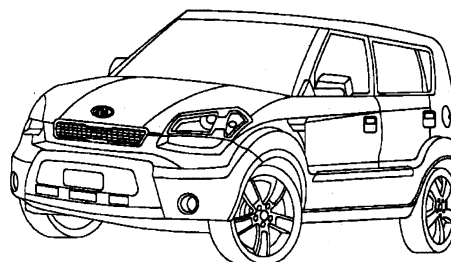

|                         |   |           |
|-------------------------|---|-----------|
| FW03131 <sup>a b</sup>  | Windshield (Solar) (W/Third Visor Frit)             | 32.0x60.0 |
| FW03051 <sup>a b</sup>  | Windshield (W/Third Visor Frit)                     | 32.0x60.0 |
| FD24410-11              | Door F/R-L (Solar)                                  | 20.1x33.8 |
| FD24159-60              | Door F/R-L  | 20.1x33.8 |
| FD24412-13              | Door R/R-L  | 18.2x29.5 |
| FD24161-62              | Door R/R-L (Solar)                                  | 18.2x29.5 |
| FQ24163-64 <sup>d</sup> | Quarter R-L (Encap)(Solar)                          | 9.5x14.5  |
| FB24414 <sup>c</sup>    | Back Window (Heated)(Solar)                         | 15.5x42.5 |
| FB24165 <sup>c</sup>    | Back Window (Ant)(Heated)(1 Holes)(Solar) (W/Wiper) | 15.5x42.5 |

<sup>a</sup> Urethane,Dam,Primer - 2 Tubes  
<sup>b</sup> Fast-Cure Urethane/Dam/Primer - Quantity 2  
<sup>c</sup> Urethane,Dam,Primer - 1.5 Tubes  
<sup>d</sup> Urethane,Dam,Primer - 1 Tube

**Spectra 4 Door Hatchback..... 2006-2009**

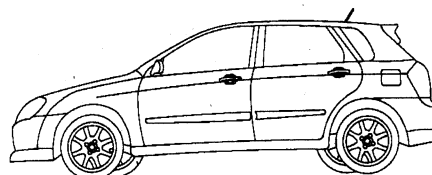

|                        |                       |           |
|------------------------|-----------------------|-----------|
| FW02494 <sup>a b</sup> | Windshield (2.0L Eng) | 36.0x57.0 |
|------------------------|-----------------------|-----------|

**Spectra (cont.)**

|   |           |
|---|-----------|
| FD23599-00 Door F/R-L (From 06/19/2007) (07-09) .....                   | 23.8x38.0 |
| FD22381-82 Door F/R-L (2 Holes) (To 06/19/2007) (06-07) .....           | 23.8x38.0 |
| FD23601-02 Door R/R-L (From 06/19/2007) (07-09) .....                   | 21.8x30.0 |
| FD22450-51 Door R/R-L (2 Holes) (To 06/19/2007) (06-07) .....           | 21.8x30.0 |
| FQ22452-53 <sup>d</sup> Quarter R-L (Encap) .....                       | 13.5x17.0 |
| FB22454 <sup>c</sup> Back Window (Ant)(Heated)(1 Holes) (W/Wiper) ..... | 18.5x51.0 |

<sup>a</sup> Urethane,Dam,Primer - 2 Tubes  
<sup>b</sup> Fast-Cure Urethane/Dam/Primer - Quantity 2  
<sup>c</sup> Urethane,Dam,Primer - 1.5 Tubes  
<sup>d</sup> Urethane,Dam,Primer - 1 Tube

**Spectra 4 Door Sedan ..... 2006-2009**

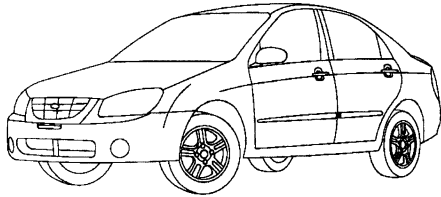

|  |           |
|--|-----------|
| FW02494 <sup>a b</sup> Windshield (2.0L Eng) .....   | 36.0x57.0 |
| FD22381-82 Door F/R-L (2 Holes) .....                | 23.8x38.0 |
| FD22383-84 Door R/R-L (2 Holes) .....                | 23.3x31.3 |
| FB22455 <sup>c</sup> Back Window (Ant)(Heated) ..... | 28.5x51.0 |
| FB22385 <sup>c</sup> Back Window (Heated) .....      | 28.5x51.0 |

<sup>a</sup> Urethane,Dam,Primer - 2 Tubes  
<sup>b</sup> Fast-Cure Urethane/Dam/Primer - Quantity 2  
<sup>c</sup> Urethane,Dam,Primer - 1.5 Tubes

**Sportage 4 Door Utility ..... 2011**

|  |  |
|--|--|
| FW03319 <sup>a b</sup> Windshield (Heated)(Solar) (W/Third Visor Frit, Heated Wiper Park Area) ..... |  |
| FW03318 <sup>a b</sup> Windshield (Solar) (W/Third Visor Frit) .....                                 |  |
| FD24873-74 Door F/R-L .....  |  |
| FD24827-28 Door F/R-L (Solar) .....  |  |
| FD24829-30 Door R/R-L (Solar) .....  |  |
| FV24831-32 Vent R/R-L (Solar) .....  |  |
| FB24834 <sup>c</sup> Back Window (Heated)(1 Holes)(Solar) (W/Spoiler, W/Wiper) .....                 |  |
| FB24833 <sup>c</sup> Back Window (Heated)(1 Holes)(Solar) (W/Wiper) .....                            |  |

<sup>a</sup> Urethane,Dam,Primer - 2 Tubes  
<sup>b</sup> Fast-Cure Urethane/Dam/Primer - Quantity 2  
<sup>c</sup> Urethane,Dam,Primer - 1.5 Tubes

**Sportage 4 Door Utility ..... 2006-2010**

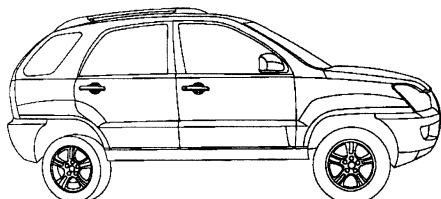

|  |           |
|--|-----------|
| FW02553 <sup>a b</sup> Windshield (Heated) (Electrochromic Mirror, W/Third Visor Frit, Heated Wiper Park Area) ..... | 37.0x57.0 |
| FW02552 <sup>a b</sup> Windshield (Heated) (W/Third Visor Frit, Heated Wiper Park Area) .....                        | 37.0x57.0 |
| FW02539 <sup>a b</sup> Windshield (W/Third Visor Frit) .....   | 37.0x57.0 |
| FD22569-70 Door F/R-L (2 Holes) .....  | 22.0x35.8 |
| FD22571-72 Door R/R-L (2 Holes) .....  | 21.8x29.5 |
| FQ22573-74 <sup>c</sup> Quarter R-L (Encap) .....  | 15.0x22.0 |
| FB22575 Back Window (Heated)(7 Holes) .....  | 22.3x50.0 |

**Sportage (cont.)**

<sup>a</sup> Urethane,Dam,Primer - 2 Tubes  
<sup>b</sup> Fast-Cure Urethane/Dam/Primer - Quantity 2  
<sup>c</sup> Urethane,Dam,Primer - 1 Tube

**Land Rover**

**LR2 4 Door Utility ..... 2008-2011**

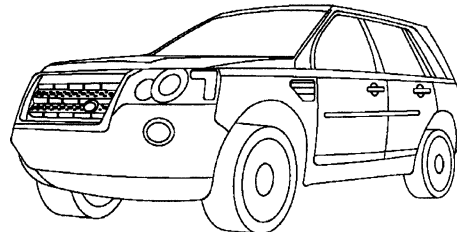

|   |           |
|---|-----------|
| FW02766 <sup>a b</sup> Windshield (Heated)(Solar) (W/Third Visor Frit, Rain Sensor) ..... | 35.0x61.0 |
| FW02765 <sup>a b</sup> Windshield (Solar) (W/Third Visor Frit, Rain Sensor) .....         | 35.0x61.0 |
| FD23488-89 Door F/R-L (Solar) .....   | 20.5x29.0 |
| FD23490-91 Door R/R-L (Solar) .....   | 20.0x20.5 |
| FQ23494-95 <sup>d</sup> Quarter R-L (Ant)(Encap)(Solar) .....                             | 19.0x24.0 |
| FV23492-93 Vent R/R-L (Solar) .....   | 9.5x19.5  |
| FB23496 <sup>c</sup> Back Window (Heated)(1 Holes)(Solar) (W/Wiper) ..                    | 19.0x53.5 |

<sup>a</sup> May Require Two Person Installation  
<sup>b</sup> High Modulus Non-Conductive Urethane,Dam,Primer - 2 Tubes  
<sup>c</sup> High Modulus Non-Conductive Urethane,Dam,Primer - 1.5 Tubes  
<sup>d</sup> High Modulus Non-Conductive Urethane,Dam,Primer - 1 Tube

**LR3 4 Door Utility ..... 2006-2009**

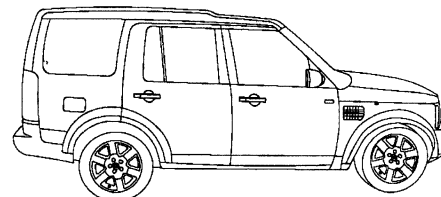

|   |           |
|---|-----------|
| FW02514 <sup>c</sup> Windshield (Heated)(Solar) (W/Third Visor Frit, Rain Sensor) .....     | 35.1x64.5 |
| FW02513 <sup>c</sup> Windshield (Heated)(Solar) (W/Third Visor Frit) .....                  | 35.1x64.5 |
| FW02512 <sup>c</sup> Windshield (Solar) (W/Third Visor Frit, Rain Sensor) .....             | 35.1x64.5 |
| FW02511 <sup>c</sup> Windshield (Solar) (W/Third Visor Frit) .....                          | 35.1x64.5 |
| FD22462-63 Door F/R-L (2 Holes) .....   | 26.8x32.0 |
| FD22464-65 Door R/R-L (1 Holes)(Solar) .....  | 22.5x25.3 |
| FR22475 <sup>a b c</sup> Roof R (Solar) (Laminated, W/Antenna Bracket) .....                | 42.0x54.0 |
| FR22474 <sup>a b c</sup> Roof R (Solar) (Laminated) .....                                   | 42.0x54.0 |
| FQ22470-71 <sup>d</sup> Quarter R-L (Ant)(Solar) (W/TV Antenna) .....                       | 24.5x32.0 |
| FQ22468-69 <sup>d</sup> Quarter R-L (Ant)(Solar) .....                                      | 24.5x32.0 |
| FV22466-67 Vent R/R-L (Solar) .....   | 8.3x20.5  |
| FB22473 <sup>d</sup> Back Window (Ant)(Heated)(1 Holes)(Solar) (W/ Diversity Antenna) ..... | 26.0x50.8 |
| FB22472 <sup>d</sup> Back Window (Heated)(1 Holes)(Solar) .....                             | 26.0x50.8 |

<sup>a</sup> May Require Two Person Installation  
<sup>b</sup> May Require Additional Urethane  
<sup>c</sup> High Modulus Non-Conductive Urethane,Dam,Primer - 2 Tubes  
<sup>d</sup> High Modulus Non-Conductive Urethane,Dam,Primer - 1.5 Tubes

**LR4 4 Door Utility ..... 2010-2011**

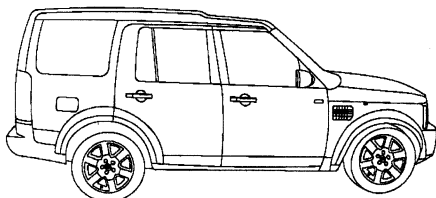

|                                |  |                  |
|--------------------------------|--|------------------|
| <b>FW03209<sup>c</sup></b>     | Windshield (Heated)(Solar) (W/Third Visor Frit, Rain Sensor) .....     | <b>35.1x64.5</b> |
| <b>FW03208<sup>c</sup></b>     | Windshield (Solar) (W/Third Visor Frit, Rain Sensor) .....             | <b>35.1x64.5</b> |
| <b>FW02513<sup>c</sup></b>     | Windshield (Heated)(Solar) (W/Third Visor Frit) .....                  | <b>35.1x64.5</b> |
| <b>FW02511<sup>c</sup></b>     | Windshield (Solar) (W/Third Visor Frit) .....                          | <b>35.1x64.5</b> |
| <b>FD22462-63</b>              | Door F/R-L (2 Holes) .....   | <b>26.8x32.0</b> |
| <b>FD22464-65</b>              | Door R/R-L (1 Holes)(Solar) .....                                      | <b>22.5x25.3</b> |
| <b>FR22475<sup>a b c</sup></b> | Roof R (Solar) (Laminated, W/Antenna Bracket) .....                    | <b>42.0x54.0</b> |
| <b>FR22474<sup>a b c</sup></b> | Roof R (Solar) (Laminated) .....                                       | <b>42.0x54.0</b> |
| <b>FQ22470-71<sup>d</sup></b>  | Quarter R-L (Ant)(Solar) (W/TV Antenna) .....                          | <b>24.5x32.0</b> |
| <b>FQ22468-69<sup>d</sup></b>  | Quarter R-L (Ant)(Solar) .....   | <b>24.5x32.0</b> |
| <b>FV22466-67</b>              | Vent R/R-L (Solar) .....   | <b>8.3x20.5</b>  |
| <b>FB22473<sup>d</sup></b>     | Back Window (Ant)(Heated)(1 Holes)(Solar) (W/ Diversity Antenna) ..... | <b>26.0x50.8</b> |
| <b>FB22472<sup>d</sup></b>     | Back Window (Heated)(1 Holes)(Solar) .....                             | <b>26.0x50.8</b> |

<sup>a</sup> May Require Two Person Installation  
<sup>b</sup> May Require Additional Urethane  
<sup>c</sup> High Modulus Non-Conductive Urethane,Dam,Primer - 2 Tubes  
<sup>d</sup> High Modulus Non-Conductive Urethane,Dam,Primer - 1.5 Tubes

**Range Rover 4 Door Utility ..... 2006-2011**

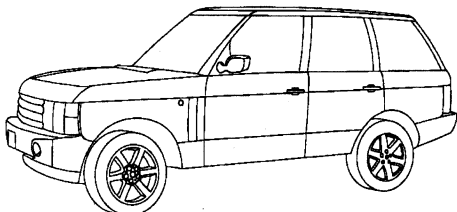

|                                  |   |                  |
|----------------------------------|---|------------------|
| <b>FW03264<sup>a c d f</sup></b> | Windshield (Heated)(Solar) (Aftermarket, Rain Sensor) (08-09) .....                       | <b>33.0x64.5</b> |
| <b>FW03215<sup>c d f</sup></b>   | Windshield (Heated)(Solar) (Acoustic Interlayer, Solar Coated, Rain Sensor) (10-11) ..... | <b>33.0x64.5</b> |
| <b>FW03214<sup>c d f</sup></b>   | Windshield (Heated)(Solar) (Acoustic Interlayer, Rain Sensor) (10-11) .....               | <b>33.0x64.5</b> |
| <b>FW02932<sup>b c d f</sup></b> | Windshield (Heated)(Solar) (Acoustic Interlayer, Rain Sensor) (08-09) .....               | <b>33.0x64.5</b> |
| <b>FW02931<sup>b c d</sup></b>   | Windshield (Heated)(Solar) (Solar Coated) (08-09) .....                                   | <b>33.0x64.5</b> |
| <b>FW02848<sup>b c d f</sup></b> | Windshield (Heated)(Solar) (Solar Coated, Rain Sensor) (08-09) .....                      | <b>33.0x64.5</b> |
| <b>FW02756<sup>c d f</sup></b>   | Windshield (Heated)(Solar) (Acoustic Interlayer, Rain Sensor) (From 11/2006) (07) .....   | <b>33.0x64.5</b> |
| <b>FW02630<sup>c d f</sup></b>   | Windshield (Heated)(Solar) (Rain Sensor) (To 11/2006) (06-07) .....                       | <b>33.0x64.5</b> |
| <b>FW02493<sup>c d</sup></b>     | Windshield (Heated)(Solar) (Solar Coated) (06-07) .....                                   | <b>33.0x64.5</b> |
| <b>FW02402<sup>c d</sup></b>     | Windshield (Heated)(Solar) (06-07) .....  | <b>33.0x64.5</b> |
| <b>FD23576-77</b>                | Door F/R-L (Solar) (Laminated, Infrared Interlayer) (08-11) .....                         | <b>23.0x32.0</b> |
| <b>FD22678-79</b>                | Door F/R-L (Solar) (Laminated) (06-07) .....  | <b>23.0x32.0</b> |
| <b>FD21673-74</b>                | Door R/R-L (Solar) .....  | <b>22.0x23.0</b> |
| <b>FQ21677-78<sup>g</sup></b>    | Quarter R-L (Ant)(Encap)(Solar) .....   | <b>20.2x26.5</b> |
| <b>FV21675-76<sup>g</sup></b>    | Vent R/R-L (Solar) .....  | <b>8.5x20.5</b>  |
| <b>FB24382<sup>e</sup></b>       | Back Window (Ant)(Heated)(Solar) (4 Leads) .....  | <b>25.0x53.2</b> |

<sup>a</sup> Not On Production Vehicles  
<sup>b</sup> On Production Vehicles  
<sup>c</sup> Urethane,Dam,Primer - 2 Tubes

**Range Rover (cont.)**

<sup>d</sup> Fast-Cure Urethane/Dam/Primer - Quantity 2  
<sup>e</sup> Urethane,Dam,Primer - 1.5 Tubes  
<sup>f</sup> Rain Sensor Kit  
<sup>g</sup> Urethane,Dam,Primer - 1 Tube

**Range Rover Sport 4 Door Utility ..... 2006-2011**

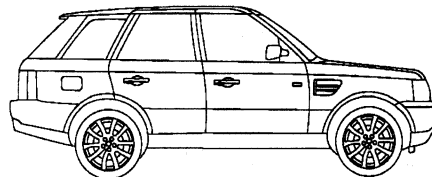

|                               |   |                  |
|-------------------------------|---|------------------|
| <b>FW03213<sup>a</sup></b>    | Windshield (Heated)(Solar) (Acoustic Interlayer, Rain Sensor) (10-11) ..... | <b>35.0x64.0</b> |
| <b>FW03212<sup>a</sup></b>    | Windshield (Heated)(Solar) (Acoustic Interlayer) (10-11) .....              | <b>35.0x64.0</b> |
| <b>FW03211<sup>a</sup></b>    | Windshield (Solar) (Acoustic Interlayer, Rain Sensor) (10-11) .....         | <b>35.0x64.0</b> |
| <b>FW03210<sup>a</sup></b>    | Windshield (Solar) (Acoustic Interlayer) (10-11) .....                      | <b>35.0x64.0</b> |
| <b>FW02593<sup>a</sup></b>    | Windshield (Heated)(Solar) (Rain Sensor) (06-09) .....                      | <b>35.0x64.0</b> |
| <b>FW02592<sup>a</sup></b>    | Windshield (Heated)(Solar) (06-09) .....                                    | <b>35.0x64.0</b> |
| <b>FW02591<sup>a</sup></b>    | Windshield (Solar) (Rain Sensor) (06-09) .....                              | <b>35.0x64.0</b> |
| <b>FW02590<sup>a</sup></b>    | Windshield (Solar) (06-09) .....  | <b>35.0x64.0</b> |
| <b>FD22723-24</b>             | Door F/R-L (2 Holes)(Solar) .....   | <b>26.8x32.0</b> |
| <b>FD22725-26</b>             | Door R/R-L (1 Holes)(Solar) .....   | <b>20.3x27.0</b> |
| <b>FQ22729-30<sup>b</sup></b> | Quarter R-L (Encap)(Solar) .....  | <b>18.0x30.0</b> |
| <b>FV22727-28</b>             | Vent R/R-L (Encap)(Solar) .....   | <b>13.0x18.0</b> |
| <b>FB22731<sup>a</sup></b>    | Back Window (Ant)(Encap)(Heated)(3 Holes)(Solar) .....                      | <b>34.0x54.0</b> |

<sup>a</sup> High Modulus Non-Conductive Urethane,Dam,Primer - 2 Tubes  
<sup>b</sup> High Modulus Non-Conductive Urethane,Dam,Primer - 1 Tube

**ES 330 4 Door Sedan ..... 2006**

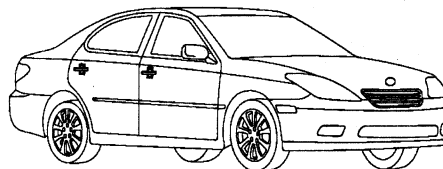

|                              |  |                  |
|------------------------------|--|------------------|
| <b>FW02277<sup>a b</sup></b> | Windshield (Solar) (Rain Sensor) ..... | <b>37.4x59.7</b> |
| <b>FW02276<sup>a b</sup></b> | Windshield (Solar) .....               | <b>37.4x59.7</b> |
| <b>FD21461-62</b>            | Door F/R-L (Solar) .....               | <b>19.5x35.0</b> |
| <b>FD21463-64</b>            | Door R/R-L (Solar) .....               | <b>18.5x29.5</b> |
| <b>FV21465-66</b>            | Vent R/R-L (Solar) .....               | <b>7.0x10.5</b>  |
| <b>FB21467<sup>a</sup></b>   | Back Window (Heated)(Solar) .....      | <b>33.0x56.0</b> |

<sup>a</sup> Urethane,Dam,Primer - 2 Tubes  
<sup>b</sup> Fast-Cure Urethane/Dam/Primer - Quantity 2

**ES 350 4 Door Sedan ..... 2007-2011**

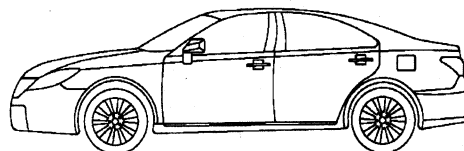

| <b>ES 350 (cont.)</b>   |           |
|---|-----------|
| FW02685 <sup>a b</sup> Windshield (Solar) (W/Panoramic Glass Roof, Rain Sensor) ..... | 35.3x57.2 |
| FW02684 <sup>a b</sup> Windshield (Solar) (Rain Sensor) .....                         | 36.5x57.6 |
| FW02683 <sup>a b</sup> Windshield (Solar) (07-09) .....                               | 36.5x57.6 |
| FD23204-05 Door F/R-L (Solar) .....   | 17.5x34.0 |
| FD23206-07 Door R/R-L (Solar) .....   | 17.5x27.5 |
| FR23783 Roof F (Solar) .....  | 7.5x45.0  |
| FR23784 Roof M (Solar) .....  | 20.0x45.0 |
| FR23785 <sup>c</sup> Roof R (Encap)(Solar) .....                                      | 33.0x45.0 |
| FV23208-09 Vent R/R-L (Solar) .....   | 9.5x12.5  |
| FB23210 <sup>c</sup> Back Window (Heated)(Solar) .....                                | 31.0x45.0 |

<sup>a</sup> Urethane,Dam,Primer - 2 Tubes  
<sup>b</sup> Fast-Cure Urethane/Dam/Primer - Quantity 2  
<sup>c</sup> Urethane,Dam,Primer - 1.5 Tubes

|                                 |                  |
|---------------------------------|------------------|
| <b>GS 300</b> 4 Door Sedan..... | <b>2006</b>      |
| <b>GS 350</b> 4 Door Sedan..... | <b>2007-2011</b> |
| <b>GS 430</b> 4 Door Sedan..... | <b>2006-2007</b> |
| <b>GS 460</b> 4 Door Sedan..... | <b>2008-2011</b> |

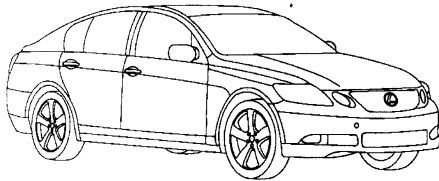

|   |           |
|---|-----------|
| FW02996 <sup>a b d</sup> Windshield (Heated)(Solar) (Heated Wiper Park Area, Rain Sensor) (08-11) ..... | 34.3x57.3 |
| FW02995 <sup>a b</sup> Windshield (Heated)(Solar) (Heated Wiper Park Area) (08-11) .....                | 34.3x57.3 |
| FW02570 <sup>a b d</sup> Windshield (Solar) (Rain Sensor) (06-11) .....                                 | 34.3x57.3 |
| FW02569 <sup>a b</sup> Windshield (Solar) (06-11) .....   | 34.3x57.3 |
| FD24552-53 Door F/R-L (Solar) (Laminated) (10-11) .....   | 18.0x26.0 |
| FD22661-62 Door F/R-L (Solar) (06-11) .....   | 18.0x26.0 |
| FD22663-64 Door R/R-L (Solar) (06-11) .....   | 18.0x28.0 |
| FV22665-66 Vent R/R-L (Solar) (06-11) .....   | 13.0x13.5 |
| FB22667 <sup>c</sup> Back Window (Ant)(Heated)(Solar) (06-11) .....                                     | 31.0x48.3 |

<sup>a</sup> Urethane,Dam,Primer - 2 Tubes  
<sup>b</sup> Fast-Cure Urethane/Dam/Primer - Quantity 2  
<sup>c</sup> Urethane,Dam,Primer - 1.5 Tubes  
<sup>d</sup> Rain Sensor Kit

|                                 |                  |
|---------------------------------|------------------|
| <b>GS 450</b> 4 Door Sedan..... | <b>2007-2011</b> |
|---------------------------------|------------------|

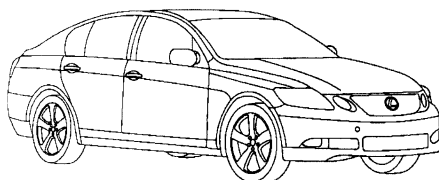

|   |           |
|---|-----------|
| FW02996 <sup>a b d</sup> Windshield (Heated)(Solar) (Heated Wiper Park Area, Rain Sensor) (08-11) ..... | 34.3x57.3 |
| FW02688 <sup>a b d</sup> Windshield (Solar) (Acoustic Interlayer, Rain Sensor) (To 06/2006) (07) .....  | 34.3x57.3 |
| FW02570 <sup>a b d</sup> Windshield (Solar) (Rain Sensor) (From 06/2006) .....                          | 34.3x57.3 |
| FD24552-53 Door F/R-L (Solar) (Laminated) (10-11) .....   | 18.0x26.0 |
| FD22661-62 Door F/R-L (Solar) .....   | 18.0x26.0 |
| FD22663-64 Door R/R-L (Solar) .....   | 18.0x28.0 |
| FV22665-66 Vent R/R-L (Solar) .....   | 13.0x13.5 |
| FB22667 <sup>c</sup> Back Window (Ant)(Heated)(Solar) .....   | 31.0x48.3 |

<sup>a</sup> Urethane,Dam,Primer - 2 Tubes  
<sup>b</sup> Fast-Cure Urethane/Dam/Primer - Quantity 2  
<sup>c</sup> Urethane,Dam,Primer - 1.5 Tubes

| <b>GS 450 (cont.)</b>        |  |
|------------------------------|--|
| <sup>d</sup> Rain Sensor Kit |  |

|                                    |                  |
|------------------------------------|------------------|
| <b>GX 460</b> 4 Door Utility ..... | <b>2010-2011</b> |
|------------------------------------|------------------|

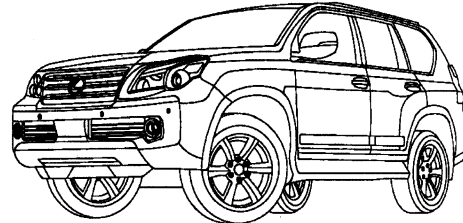

|   |           |
|---|-----------|
| FW03229 <sup>a b d</sup> Windshield (Heated)(Solar) (Electrochromic Mirror, W/Third Visor Frit, W/Lane Departure Warning System, Heated Wiper Park Area, Rain Sensor) ..... | 31.0x58.5 |
| FW03228 <sup>a b d</sup> Windshield (Heated)(Solar) (Electrochromic Mirror, W/Third Visor Frit, Heated Wiper Park Area, Rain Sensor) .....                                  | 31.0x58.5 |
| FD24615-16 Door F/R-L (Solar) .....   | 21.0x34.0 |
| FD24617-18 Door R/R-L (Solar) .....   | 21.0x23.5 |
| FQ24623-24 <sup>e</sup> Quarter R-L (Ant)(Encap)(Solar) .....   | 18.0x27.0 |
| FQ24621-22 <sup>e</sup> Quarter R-L (Encap)(Solar) .....  | 18.0x27.0 |
| FV24619-20 Vent R/R-L (Solar) .....   | 7.5x17.0  |
| FB24625 <sup>c</sup> Back Window (Heated)(5 Holes)(Solar) .....   | 21.0x52.0 |

<sup>a</sup> Urethane,Dam,Primer - 2 Tubes  
<sup>b</sup> Fast-Cure Urethane/Dam/Primer - Quantity 2  
<sup>c</sup> Urethane,Dam,Primer - 1.5 Tubes  
<sup>d</sup> Rain Sensor Kit  
<sup>e</sup> Urethane,Dam,Primer - 1 Tube

|                                    |                  |
|------------------------------------|------------------|
| <b>GX 470</b> 4 Door Utility ..... | <b>2006-2009</b> |
|------------------------------------|------------------|

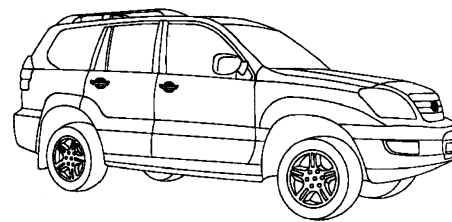

|  |           |
|--|-----------|
| FW02681 <sup>a b</sup> Windshield (Solar) (Electrochromic Mirror, W/Third Visor Frit, Rain Sensor) ..... | 30.5x58.3 |
| FD21848-49 Door F/R-L (Solar) .....  | 17.8x29.6 |
| FD21850-51 Door R/R-L (Solar) .....  | 22.5x34.0 |
| FQ21854-55 Quarter R-L (Encap)(1 Holes)(Solar) (Movable) .....   | 19.3x29.0 |
| FV21852-53 Vent R/R-L (Solar) .....  | 7.0x19.0  |
| FB21856 <sup>c</sup> Back Window (Encap)(Heated)(1 Holes)(Solar) .....                                   | 21.3x52.5 |

<sup>a</sup> Urethane,Dam,Primer - 2 Tubes  
<sup>b</sup> Fast-Cure Urethane/Dam/Primer - Quantity 2  
<sup>c</sup> Urethane,Dam,Primer - 1.5 Tubes

**HS 250 4 Door Sedan..... 2010-2011**

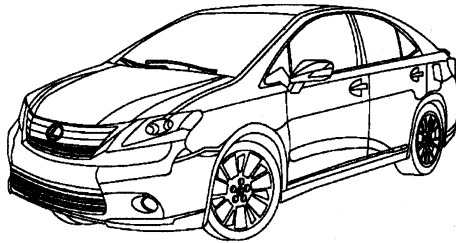

|   |                  |
|---|------------------|
| <b>FW03193<sup>a b c</sup></b> Windshield (Heated)(Solar) (W/Third Visor Frit, Heated Wiper Park Area, Acoustic Infrared Interlayer, Rain Sensor) ..... | <b>38.5x53.0</b> |
| <b>FW03192<sup>a b</sup></b> Windshield (Heated)(Solar) (W/Third Visor Frit, Heated Wiper Park Area, Acoustic Infrared Interlayer) .....                | <b>38.5x53.0</b> |
| <b>FW03191<sup>a b c</sup></b> Windshield (HUD)(Solar) (W/Third Visor Frit, Acoustic Infrared Interlayer, Rain Sensor) .....                            | <b>38.5x53.0</b> |
| <b>FW03190<sup>a b c</sup></b> Windshield (Solar) (W/Third Visor Frit, Acoustic Infrared Interlayer, Rain Sensor) .....                                 | <b>38.5x53.0</b> |
| <b>FW03177<sup>a b</sup></b> Windshield (Solar) (W/Third Visor Frit, Acoustic Infrared Interlayer) .....  | <b>38.5x53.0</b> |
| <b>FD24672-73</b> Door F/R-L (Solar) (Aftermarket) .....  | <b>19.0x33.5</b> |
| <b>FD24507-08</b> Door F/R-L (Solar) (Hydrophobic Coating) .....  | <b>19.0x33.5</b> |
| <b>FD24509-10</b> Door R/R-L (Solar) .....  | <b>19.0x25.0</b> |
| <b>FV24505-06</b> Vent F/R-L (Encap)(Solar) .....   | <b>9.0x11.5</b>  |
| <b>FV24511-12</b> Vent R/R-L (Solar) .....  | <b>10.0x10.5</b> |
| <b>FB24513<sup>a</sup></b> Back Window (Ant)(Heated)(Solar) .....   | <b>33.0x51.0</b> |

<sup>a</sup> Urethane,Dam,Primer - 2 Tubes  
<sup>b</sup> Fast-Cure Urethane/Dam/Primer - Quantity 2  
<sup>c</sup> Rain Sensor Kit

**IS 250 4 Door Sedan ..... 2006-2011**  
**IS 350 4 Door Sedan ..... 2006-2011**  
**IS-F 4 Door Sedan..... 2008-2011**

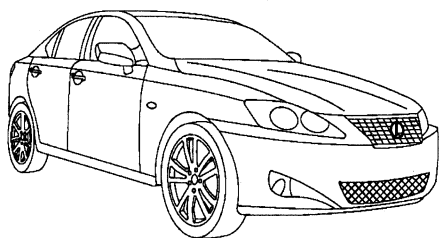

|  |                  |
|--|------------------|
| <b>FW03299<sup>a b</sup></b> Windshield (Heated) (W/Third Visor Frit, Heated Wiper Park Area, Rain Sensor) (10-11) ..... | <b>31.8x52.8</b> |
| <b>FW03298<sup>a b</sup></b> Windshield (Heated) (W/Third Visor Frit, Heated Wiper Park Area) (10-11) .....              | <b>31.8x52.8</b> |
| <b>FW02624<sup>a b</sup></b> Windshield (W/Third Visor Frit, Rain Sensor) (06-09) .....                                  | <b>31.8x52.8</b> |
| <b>FW02623<sup>a b</sup></b> Windshield (W/Third Visor Frit) (06-11) .....   | <b>31.8x52.8</b> |
| <b>FD24030-31</b> Door F/R-L (Solar) (Hydrophobic Coating) (08-11) .....   | <b>20.5x36.3</b> |
| <b>FD22900-01</b> Door F/R-L (Solar) (06-11) .....   | <b>20.5x36.3</b> |
| <b>FD22902-03</b> Door R/R-L (Solar) (06-11) .....   | <b>17.8x23.5</b> |
| <b>FV22904-05</b> Vent R/R-L (Solar) (06-11) .....   | <b>8.8x10.5</b>  |
| <b>FB22906<sup>c</sup></b> Back Window (Ant)(Heated)(Solar) (06-11) .....  | <b>29.5x45.0</b> |

<sup>a</sup> Urethane,Dam,Primer - 2 Tubes  
<sup>b</sup> Fast-Cure Urethane/Dam/Primer - Quantity 2  
<sup>c</sup> Urethane,Dam,Primer - 1.5 Tubes

**IS 250C 2 Door Convertible..... 2010-2011**  
**IS 350C 2 Door Convertible..... 2010-2011**

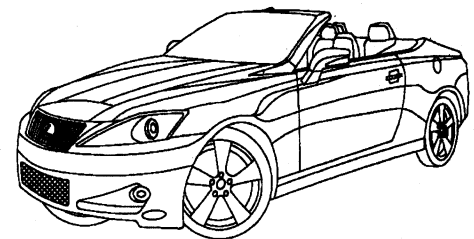

|   |                  |
|---|------------------|
| <b>FW03275<sup>a c d</sup></b> Windshield (Solar) (W/Third Visor Frit, Aftermarket, Rain Sensor) .....              | <b>31.5x53.0</b> |
| <b>FW03274<sup>a c d</sup></b> Windshield (Solar) (W/Third Visor Frit, Aftermarket) .....                           | <b>31.5x53.0</b> |
| <b>FW03116<sup>b c d</sup></b> Windshield (Ant)(Solar) (W/Third Visor Frit, Acoustic Interlayer, Rain Sensor) ..... | <b>31.5x53.0</b> |
| <b>FW03115<sup>b c d</sup></b> Windshield (Ant)(Solar) (W/Third Visor Frit, Acoustic Interlayer) .....              | <b>31.5x53.0</b> |
| <b>FD24352-53</b> Door F/R-L (Solar) .....  | <b>17.0x40.0</b> |
| <b>FQ24354-55</b> Quarter R-L (Solar) .....   | <b>17.0x25.5</b> |
| <b>FB24356<sup>e</sup></b> Back Window (Heated)(Solar) .....  |                  |

<sup>a</sup> Not On Production Vehicles  
<sup>b</sup> On Production Vehicles  
<sup>c</sup> Urethane,Dam,Primer - 2 Tubes  
<sup>d</sup> Fast-Cure Urethane/Dam/Primer - Quantity 2  
<sup>e</sup> Urethane,Dam,Primer - 1.5 Tubes

**LS 430 4 Door Sedan..... 2006**

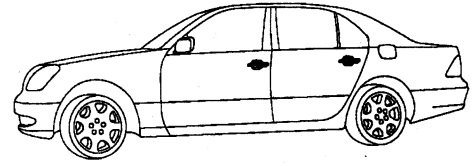

|   |                  |
|---|------------------|
| <b>FW02472<sup>a b c</sup></b> Windshield (Heated)(Solar) (Coolant Heated, Bottom Edge, Canada Only, Rain Sensor) ..... | <b>34.9x61.4</b> |
| <b>FW02471<sup>a b</sup></b> Windshield (Heated)(Solar) (Coolant Heated, Bottom Edge, Canada Only) .....                | <b>34.9x61.4</b> |
| <b>FW02222<sup>a b</sup></b> Windshield (Solar) (Rain Sensor) .....   | <b>34.9x61.4</b> |
| <b>FW02221<sup>a b</sup></b> Windshield (Solar) .....   | <b>34.9x61.4</b> |
| <b>FD21180-81</b> Door F/R-L (Solar) (Laminated) .....  | <b>20.3x33.8</b> |
| <b>FD21178-79</b> Door F/R-L (Solar) .....  | <b>20.3x33.8</b> |
| <b>FD21184-85</b> Door R/R-L (Solar) (Laminated) .....  | <b>20.3x26.5</b> |
| <b>FD21182-83</b> Door R/R-L (Solar) .....  | <b>20.3x26.5</b> |
| <b>FV21188-89</b> Vent R/R-L (Solar) (Laminated) .....  | <b>11.4x14.8</b> |
| <b>FV21186-87</b> Vent R/R-L (Solar) .....  | <b>11.4x14.8</b> |
| <b>FB21190<sup>a</sup></b> Back Window (Ant)(Heated)(Solar) .....   | <b>30.0x57.2</b> |

<sup>a</sup> Urethane,Dam,Primer - 2 Tubes  
<sup>b</sup> Fast-Cure Urethane/Dam/Primer - Quantity 2  
<sup>c</sup> Rain Sensor Kit

**LS 460 4 Door Sedan..... 2007-2011**

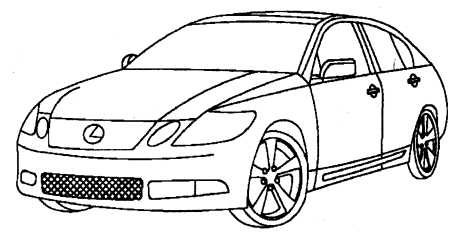

| <b>LS 460 (cont.)</b>  |           |
|--|-----------|
| FW02764 <sup>a b</sup> Windshield (Heated)(Solar) (Hydrophobic Coating, Rain Sensor) ..... | 34.0x59.5 |
| FW02763 <sup>a b</sup> Windshield (Heated)(Solar) (Hydrophobic Coating) ...                | 34.0x59.5 |
| FW02762 <sup>a b</sup> Windshield (Heated)(Solar) (Rain Sensor) .....                      | 34.0x59.5 |
| FW02761 <sup>a b</sup> Windshield (Heated)(Solar) .....                                    | 34.0x59.5 |
| FW02760 <sup>a b</sup> Windshield (Solar) (Hydrophobic Coating, Rain Sensor) .....         | 34.0x59.5 |
| FW02759 <sup>a b</sup> Windshield (Solar) (Hydrophobic Coating) .....                      | 34.0x59.5 |
| FW02728 <sup>a b</sup> Windshield (Solar) (Rain Sensor) .....                              | 34.0x59.5 |
| FW02727 <sup>a b</sup> Windshield (Solar) .....  | 34.0x59.5 |
| FD23360-61 Door F/R-L (Solar) .....  | 19.8x40.0 |
| FD23362-63 Door R/R-L (Solar) .....  | 18.5x27.5 |
| FV23366-67 Vent R/R-L (Solar) .....  | 10.0x11.0 |
| FB23370 <sup>c</sup> Back Window (Ant)(Heated)(Solar) .....                                | 29.5x51.5 |

**LS 460 L** 4 Door Sedan ..... **2007-2011**  
**LS 600 L** 4 Door Sedan ..... **2008-2011**

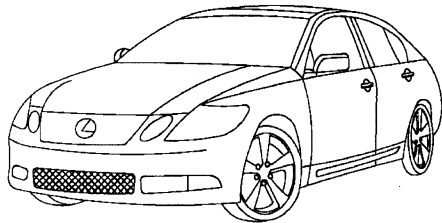

|  |           |
|--|-----------|
| FW02764 <sup>a b</sup> Windshield (Heated)(Solar) (Hydrophobic Coating, Rain Sensor) (07-11) ..... | 34.0x59.5 |
| FW02763 <sup>a b</sup> Windshield (Heated)(Solar) (Hydrophobic Coating) (07-11) .....              | 34.0x59.5 |
| FW02762 <sup>a b</sup> Windshield (Heated)(Solar) (Rain Sensor) (07-11) .....                      | 34.0x59.5 |
| FW02761 <sup>a b</sup> Windshield (Heated)(Solar) (07-11) .....                                    | 34.0x59.5 |
| FW02760 <sup>a b</sup> Windshield (Solar) (Hydrophobic Coating, Rain Sensor) (07-11) .....         | 34.0x59.5 |
| FW02759 <sup>a b</sup> Windshield (Solar) (Hydrophobic Coating) (07-11) .....                      | 34.0x59.5 |
| FW02728 <sup>a b</sup> Windshield (Solar) (Rain Sensor) (07-11) .....                              | 34.0x59.5 |
| FW02727 <sup>a b</sup> Windshield (Solar) (07-11) .....  | 34.0x59.5 |
| FD23358-59 Door F/R-L (Solar) (Laminated) (07-11) .....  | 19.8x40.0 |
| FD23634-35 Door R/R-L (Solar) (07-11) .....  | 18.0x31.5 |
| FD23364-65 Door R/R-L (Solar) (Laminated) (07-11) .....  | 18.5x31.5 |
| FV23368-69 Vent R/R-L (Solar) (Laminated) (07-11) .....  | 10.0x11.0 |
| FV23366-67 Vent R/R-L (Solar) (07-11) .....  | 10.0x11.0 |
| FB23370 <sup>c</sup> Back Window (Ant)(Heated)(Solar) (07-11) .....                                | 29.5x51.5 |

**LX 470** 4 Door Utility ..... **2006-2007**

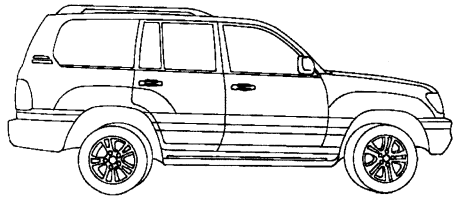

|   |           |
|---|-----------|
| FW02520 <sup>a b</sup> Windshield (W/Night Vision, Rain Sensor) ..... | 30.6x62.0 |
| FW02519 <sup>a b</sup> Windshield (Rain Sensor) .....                 | 30.6x62.0 |
| FD20390-91 Door F/R-L .....   | 23.5x36.0 |

| <b>LX 470 (cont.)</b>                            |           |
|--|-----------|
| FD20392-93 Door R/R-L .....                      | 23.0x25.0 |
| FQ21422 Quarter L (1 Holes) (Movable) .....      | 19.8x34.0 |
| FQ21421 Quarter R (Ant)(1 Holes) (Movable) ..... | 19.8x34.0 |
| FV20394-95 Vent R/R-L .....                      | 10.0x20.5 |
| FB20398 <sup>c</sup> Back Window (Heated) .....  | 22.0x55.0 |

**LX 570** 4 Door Utility ..... **2008-2011**

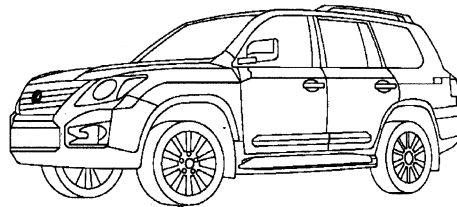

|  |           |
|--|-----------|
| FW02909 <sup>a b</sup> Windshield (Heated)(Solar) (W/Third Visor Frit, Acoustic Interlayer, Heated Wiper Park Area, Rain Sensor) ..... | 31.5x61.0 |
| FD24022-23 Door F/R-L (Solar) (Laminated) .....  | 21.0x32.5 |
| FD24024-25 Door R/R-L (Solar) .....  | 21.0x24.5 |
| FQ24028-29 <sup>d</sup> Quarter R-L (Encap)(Solar) .....   | 20.0x27.5 |
| FV24026-27 Vent R/R-L (Solar) .....  | 8.5x19.0  |
| FB23733 <sup>c</sup> Back Window (Heated)(1 Holes)(Solar) .....  | 19.5x58.5 |

**RX 330** 4 Door Utility ..... **2006**  
**RX 350** 4 Door Utility ..... **2007-2009**

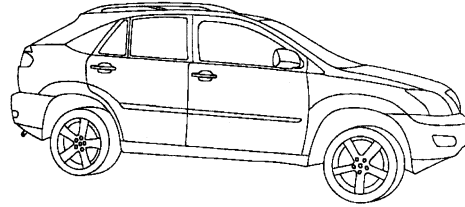

|  |           |
|--|-----------|
| FW02647 <sup>c e f</sup> Windshield (Solar) (Acoustic Interlayer) (From 02/08/2006) (06-09) .....  | 41.7x61.8 |
| FW02622 <sup>a c e f b</sup> Windshield (Heated)(Solar) (Acoustic Interlayer, Heated Wiper Park Area, Rain Sensor) (From 02/08/2006) (06-09) ..... | 41.7x61.8 |
| FW02621 <sup>a c e f b</sup> Windshield (Solar) (Acoustic Interlayer, Rain Sensor) (From 02/08/2006) (06-09) .....                                 | 41.7x61.8 |
| FW02414 <sup>a b d e f</sup> Windshield (Heated)(Solar) (Heated Wiper Park Area, Rain Sensor) (To 02/08/2006) (06-09) .....                        | 41.7x61.8 |
| FW02413 <sup>e f</sup> Windshield (Heated)(Solar) (Heated Wiper Park Area) (To 02/08/2006) (06) .....  | 41.7x61.8 |
| FW02412 <sup>b d e f</sup> Windshield (Solar) (To 02/08/2006) (06-09) .....  | 41.7x61.8 |
| FW02390 <sup>a b d e f</sup> Windshield (Solar) (Rain Sensor) (To 02/08/2006) (06-09) .....  | 41.7x61.8 |
| FD21935-36 Door F/R-L (Solar) (06-09) .....  | 21.0x35.0 |
| FD21937-38 Door R/R-L (Solar) (06-09) .....  | 20.0x22.5 |
| FQ21941-42 <sup>i</sup> Quarter R-L (Encap)(Solar) (06-09) .....   | 12.5x16.0 |
| FV21939-40 Vent R/R-L (Solar) (06-09) .....  | 12.0x14.5 |
| FB21943 <sup>g</sup> Back Window (Ant)(Heated)(1 Holes)(Solar) (06-09) .....   | 22.5x55.5 |

**RX 330 (cont.)**

<sup>d</sup> Not On Production Vehicles From 2/8/2006-2009  
<sup>e</sup> Urethane,Dam,Primer - 2 Tubes  
<sup>f</sup> Fast-Cure Urethane/Dam/Primer - Quantity 2  
<sup>g</sup> Urethane,Dam,Primer - 1.5 Tubes  
<sup>h</sup> Rain Sensor Kit  
<sup>i</sup> Urethane,Dam,Primer - 1 Tube

---

**RX 350 4 Door Utility ..... 2010-2011**  
**RX 450 4 Door Utility ..... 2010-2011**

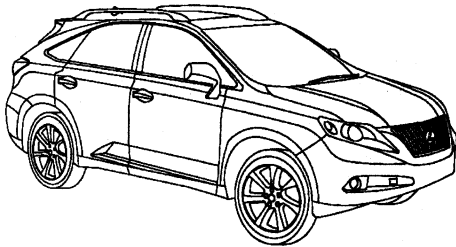

**FW03271<sup>a c d</sup>** Windshield (W/Third Visor Frit, Aftermarket, Heated Wiper Park Area, Rain Sensor) ..... **43.4x56.9**  
**FW03270<sup>a c d</sup>** Windshield (W/Third Visor Frit, Aftermarket, Rain Sensor) ..... **43.4x56.9**  
**FW03269<sup>a c d</sup>** Windshield (W/Third Visor Frit, Aftermarket) ..... **43.4x56.9**  
**FW03153<sup>b c d</sup>** Windshield (HUD)(Heated)(W/Third Visor Frit, Acoustic Interlayer, Heated Wiper Park Area, Rain Sensor) ..... **43.4x56.9**  
**FW03152<sup>b c d</sup>** Windshield (HUD) (W/Third Visor Frit, Acoustic Interlayer, Rain Sensor) ..... **43.4x56.9**  
**FW03151<sup>b c d</sup>** Windshield (HUD) (W/Third Visor Frit, Acoustic Interlayer) ..... **43.4x56.9**  
**FW03054<sup>b c d</sup>** Windshield (Heated) (W/Third Visor Frit, Acoustic Interlayer, Heated Wiper Park Area, Rain Sensor) ..... **43.4x56.9**  
**FW03053<sup>b c d</sup>** Windshield (W/Third Visor Frit, Acoustic Interlayer, Rain Sensor) ..... **43.4x56.9**  
**FW03052<sup>b c d</sup>** Windshield (W/Third Visor Frit, Acoustic Interlayer) ..... **43.4x56.9**  
**FD24698-99** Door F/R-L (Solar) (Laminated) ..... **19.0x34.5**  
**FD24166-67** Door F/R-L (Solar) ..... **19.0x34.5**  
**FD24168-69** Door R/R-L (Solar) ..... **19.0x29.5**  
**FQ24170-71<sup>f</sup>** Quarter R-L (Encap)(Solar) ..... **17.0x21.0**  
**FV24371-72<sup>f</sup>** Vent F/R-L (Encap) ..... **7.0x 7.5**  
**FB24172<sup>e</sup>** Back Window (Ant)(Heated)(1 Holes)(Solar) ..... **22.0x54.5**

<sup>a</sup> Not On Production Vehicles  
<sup>b</sup> On Production Vehicles  
<sup>c</sup> Urethane,Dam,Primer - 2 Tubes  
<sup>d</sup> Fast-Cure Urethane/Dam/Primer - Quantity 2  
<sup>e</sup> Urethane,Dam,Primer - 1.5 Tubes  
<sup>f</sup> Urethane,Dam,Primer - 1 Tube

**RX 400 4 Door Utility ..... 2006-2009**

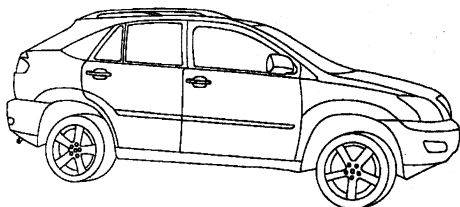

**FW02647<sup>b d f g</sup>** Windshield (Solar) (Acoustic Interlayer) ..... **41.7x61.8**  
**FW02622<sup>a b d f g h</sup>** Windshield (Heated)(Solar) (Acoustic Interlayer, Heated Wiper Park Area, Rain Sensor) ..... **41.7x61.8**  
**FW02621<sup>a b d f g h</sup>** Windshield (Solar) (Acoustic Interlayer, Rain Sensor) ..... **41.7x61.8**

**RX 400 (cont.)**

**FW02414<sup>a c e f g</sup>** Windshield (Heated)(Solar) (Heated Wiper Park Area, Rain Sensor) ..... **41.7x61.8**  
**FW02412<sup>c e f g</sup>** Windshield (Solar) ..... **41.7x61.8**  
**FW02390<sup>a c e f g</sup>** Windshield (Solar) (Rain Sensor) ..... **41.7x61.8**  
**FD21935-36** Door F/R-L (Solar) ..... **21.0x35.0**  
**FD21937-38** Door R/R-L (Solar) ..... **20.0x22.5**  
**FQ21941-42<sup>j</sup>** Quarter R-L (Encap)(Solar) ..... **12.5x16.0**  
**FV21939-40** Vent R/R-L (Solar) ..... **12.0x14.5**  
**FB21943<sup>h</sup>** Back Window (Ant)(Heated)(1 Holes)(Solar) ..... **22.5x55.5**

<sup>a</sup> May Require Replacement of Rain Sensor  
<sup>b</sup> On Production Vehicles  
<sup>c</sup> On Production Vehicles 2004-To 2/8/2006  
<sup>d</sup> On Production Vehicles From 2/8/2006  
<sup>e</sup> Not On Production Vehicles From 2/8/2006-2009  
<sup>f</sup> Urethane,Dam,Primer - 2 Tubes  
<sup>g</sup> Fast-Cure Urethane/Dam/Primer - Quantity 2  
<sup>h</sup> Urethane,Dam,Primer - 1.5 Tubes  
<sup>i</sup> Rain Sensor Kit  
<sup>j</sup> Urethane,Dam,Primer - 1 Tube

**SC 430 2 Door Convertible ..... 2006-2010**

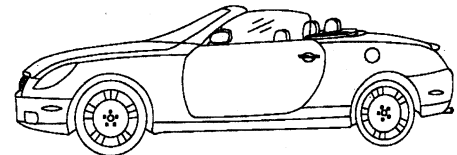

**FW02257<sup>a b</sup>** Windshield (Encap) ..... **35.0x56.0**  
**FD21377-78** Door F/R-L (Solar) ..... **15.0x37.0**  
**FQ21379-80** Quarter R-L (Encap)(Solar) ..... **12.0x15.0**  
**FB21381<sup>c</sup>** Back Window (Heated)(Solar) ..... **23.8x43.0**

<sup>a</sup> Urethane,Dam,Primer - 2 Tubes  
<sup>b</sup> Fast-Cure Urethane/Dam/Primer - Quantity 2  
<sup>c</sup> Urethane,Dam,Primer - 1.5 Tubes

**Aviator 4 Door Utility ..... 2006**

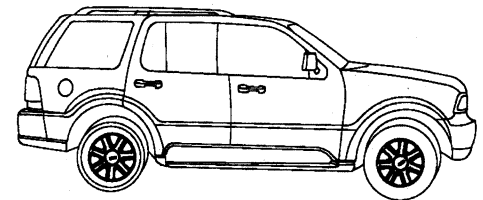

**DW01509<sup>a b</sup>** Windshield (Solar) (Export Only, E-Mark) ..... **33.2x64.4**  
**DW01474<sup>a b</sup>** Windshield (Solar) ..... **33.2x64.4**  
**DD10171-72** Door F/R-L (Solar) (Laminated) ..... **23.4x32.2**  
**DD09872-73** Door R/R-L (Solar) (E-Mark) ..... **21.7x23.7**  
**DR09298** Roof (Solar) ..... **16.3x31.8**  
**DQ10451<sup>c</sup>** Quarter L (Encap)(Solar) ..... **19.4x35.9**  
**DQ10450<sup>c</sup>** Quarter R (Ant)(Encap)(Solar) ..... **19.4x35.9**  
**DV10093-94** Vent R/R-L (Solar) (Chrome Moulding) ..... **9.7x19.6**  
**DB10830** Back Window (Heated)(5 Holes)(Solar) (Assembly, Oxford White Clearcoat) ..... **29.0x55.0**  
**DB10820** Back Window (Heated)(5 Holes)(Solar) (Charcoal Beige, Assembly) ..... **29.0x55.0**  
**DB10819** Back Window (Heated)(5 Holes)(Solar) (Light Tundra/Titanium Green, Assembly) ..... **29.0x55.0**  
**DB10818** Back Window (Heated)(5 Holes)(Solar) (Assembly, Ivory Parchment) ..... **29.0x55.0**  
**DB10732** Back Window (Encap)(Heated)(5 Holes)(Solar) (Assembly, Export Only, Paint To Match) ..... **29.0x55.0**

| <i>Aviator</i> (cont.) |   |
|------------------------|---|
| DB10731                | Back Window (Encap)(Heated)(5 Holes)(Solar) (Assembly, Paint To Match) ..... 29.0x55.0  |
| DB10540                | Back Window (Heated)(5 Holes)(Solar) (Assembly, Ceramic White Tri-Coat) ..... 29.0x55.0 |
| DB10539                | Back Window (Heated)(5 Holes)(Solar) (Silver Birch, Assembly) ..... 29.0x55.0           |
| DB10538                | Back Window (Heated)(5 Holes)(Solar) (Assembly, Mineral Gray) ..... 29.0x55.0           |
| DB10537                | Back Window (Heated)(5 Holes)(Solar) (Ebony, Assembly) ..... 29.0x55.0                  |
| DB10460                | Back Window (Heated)(5 Holes)(Solar) (Assembly, Red Fire) ..... 29.0x55.0               |
| DB10459                | Back Window (Heated)(5 Holes)(Solar) (Assembly, Pueblo Gold) ..... 29.0x55.0            |
| DB10458                | Back Window (Heated)(5 Holes)(Solar) (Assembly, Dark Blue Pearl) ..... 29.0x55.0        |

<sup>a</sup> Urethane,Dam,Primer - 2 Tubes  
<sup>b</sup> Fast-Cure Urethane/Dam/Primer - Quantity 2  
<sup>c</sup> Urethane,Dam,Primer - 1.5 Tubes

**LS 4 Door Sedan ..... 2006**

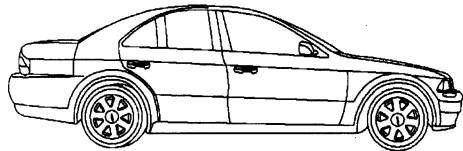

|                          |  |
|--------------------------|--|
| DW01493 <sup>a b c</sup> | Windshield (Heated)(Solar) (W/Third Visor Frit, Heated Wiper Park Area, Rain Sensor) ..... 44.6x59.1 |
| DW01437 <sup>a b</sup>   | Windshield (Heated)(Solar) (W/Third Visor Frit, Heated Wiper Park Area) ..... 44.6x59.1              |
| DD09461-62               | Door F/R-L (Solar) ..... 22.4x36.6   |
| DD09463-64               | Door R/R-L (Solar) ..... 22.4x24.1   |
| DR10324                  | Roof (Solar) (Assembly) ..... 10.9x12.6  |
| DV10322-23               | Vent R/R-L (Solar) (Black Frame) ..... 10.9x12.6   |
| DV10320-21               | Vent R/R-L (Solar) (Chrome Frame) ..... 10.9x12.6  |
| DB10208 <sup>a</sup>     | Back Window (Ant)(Heated)(Solar) ..... 29.3x55.1   |

<sup>a</sup> Urethane,Dam,Primer - 2 Tubes  
<sup>b</sup> Fast-Cure Urethane/Dam/Primer - Quantity 2  
<sup>c</sup> Rain Sensor Kit

**MKS 4 Door Sedan ..... 2009-2011**

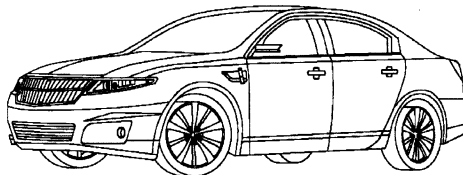

|                          |   |
|--------------------------|---|
| DW01866 <sup>a c d</sup> | Windshield (Solar) (W/Third Visor Frit, Aftermarket, Rain Sensor) ..... 36.9x60.6                           |
| DW01865 <sup>a c d</sup> | Windshield (Solar) (W/Third Visor Frit, Aftermarket) ..... 36.9x60.6  |
| DW01727 <sup>b c d</sup> | Windshield (Solar) (High Beam Sensor, W/Third Visor Frit, Acoustic Interlayer, Rain Sensor) ..... 36.9x60.6 |
| DW01726 <sup>b c d</sup> | Windshield (Solar) (W/Third Visor Frit, Acoustic Interlayer) ..... 36.9x60.6                                |
| DD11467-68               | Door F/R-L (Solar) (Laminated, Acoustic Interlayer) .. 20.6x35.5  |
| DD11469-70               | Door R/R-L (Solar) ..... 18.5x25.7  |
| DR11473                  | Roof F (Solar) (Assembly, Movable) ..... 18.5x33.0  |
| DR11474 <sup>e</sup>     | Roof R (Encap)(Solar) (Stationary) ..... 24.0x33.0  |
| DV11471-72               | Vent R/R-L (Solar) ..... 12.9x13.6  |
| DB11771 <sup>c</sup>     | Back Window (Ant)(Heated)(Solar) (High Amp) (From 12/01/2009) (10-11) ..... 35.3x54.3                       |
| DB11475 <sup>c</sup>     | Back Window (Ant)(Heated)(Solar) (To 11/30/2009) (09-10) ..... 35.3x54.3                                    |

<sup>a</sup> Not On Production Vehicles

| <i>MKS</i> (cont.)                                      |  |
|---|--|
| <sup>b</sup> On Production Vehicles                     |  |
| <sup>c</sup> Urethane,Dam,Primer - 2 Tubes              |  |
| <sup>d</sup> Fast-Cure Urethane/Dam/Primer - Quantity 2 |  |
| <sup>e</sup> Urethane,Dam,Primer - 1.5 Tubes            |  |

**MKT 4 Door Utility ..... 2010-2011**

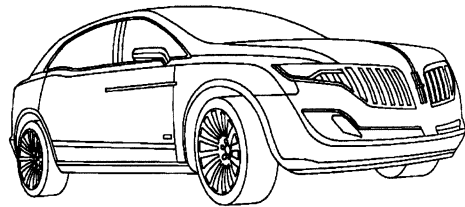

|                          |   |
|--------------------------|---|
| DW01871 <sup>a c d</sup> | Windshield (Solar) (W/Third Visor Frit, Aftermarket, Rain Sensor) ..... 39.8x60.8                           |
| DW01785 <sup>b c d</sup> | Windshield (Solar) (High Beam Sensor, W/Third Visor Frit, Acoustic Interlayer, Rain Sensor) ..... 39.8x60.8 |
| DD11633-34               | Door F/R-L (Solar) (Laminated, Acoustic Interlayer) .. 20.1x36.7  |
| DD11637-38               | Door R/R-L (1 Holes)(Solar) ..... 19.5x31.3   |
| DR11713 <sup>c</sup>     | Roof F (Solar) (Stationary) ..... 40.5x50.5   |
| DR11712                  | Roof F (Solar) (Movable) ..... 37.2x37.5  |
| DR11715 <sup>e</sup>     | Roof R (Solar) (Stationary, W/Stationary Front Roof) . 31.5x45.0  |
| DR11714 <sup>e</sup>     | Roof R (Solar) (Stationary, W/Movable Front Roof) ... 30.5x36.5   |
| DQ11645-46 <sup>f</sup>  | Quarter R-L (Encap)(Solar) ..... 12.8x24.3  |
| DV11641-42               | Vent R/R-L (Solar) ..... 6.8x16.4   |
| DB11648 <sup>e</sup>     | Back Window (Heated)(Solar) ..... 24.7x55.2   |

<sup>a</sup> Not On Production Vehicles  
<sup>b</sup> On Production Vehicles  
<sup>c</sup> Urethane,Dam,Primer - 2 Tubes  
<sup>d</sup> Fast-Cure Urethane/Dam/Primer - Quantity 2  
<sup>e</sup> Urethane,Dam,Primer - 1.5 Tubes  
<sup>f</sup> Urethane,Dam,Primer - 1 Tube

**MKX 4 Door Utility ..... 2011**

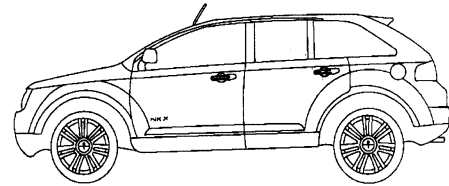

|                          |   |
|--------------------------|---|
| DW01845 <sup>b c d</sup> | Windshield (Solar) (W/Third Visor Frit, Acoustic Interlayer, Rain Sensor) ..... 43.2x62.5 |
| DW01654 <sup>b c d</sup> | Windshield (Solar) (W/Third Visor Frit, Acoustic Interlayer) ..... 43.2x62.5              |
| DW01653 <sup>a c d</sup> | Windshield (Solar) (W/Third Visor Frit) ..... 43.2x62.5                                   |
| DD11847-48               | Door F/R-L (Solar) (Laminated, Acoustic Interlayer) .. 22.3x39.0                          |
| DD11136-37               | Door F/R-L (Solar) ..... 22.3x39.0  |
| DD11140-41               | Door R/R-L (Solar) ..... 23.0x23.5  |
| DR11712                  | Roof F (Solar) (Movable) ..... 37.2x37.5  |
| DR11779                  | Roof R (Solar) (Stationary) ..... 37.2x37.5   |
| DQ11424-25 <sup>e</sup>  | Quarter R-L (Encap)(Solar) (Chrome/Black Frame) ... 16.3x26.3                             |
| DV11144-45               | Vent R/R-L (Solar) ..... 10.0x17.8  |
| DB11157 <sup>c</sup>     | Back Window (Heated)(Solar) ..... 27.8x56.1   |

<sup>a</sup> Not On Production Vehicles  
<sup>b</sup> On Production Vehicles  
<sup>c</sup> Urethane,Dam,Primer - 2 Tubes  
<sup>d</sup> Fast-Cure Urethane/Dam/Primer - Quantity 2  
<sup>e</sup> Urethane,Dam,Primer - 1 Tube



**MKX 4 Door Utility ..... 2007-2010**

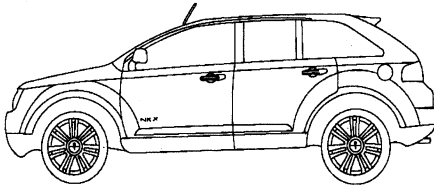

|  |                  |
|--|------------------|
| <b>DW01654<sup>bcd</sup></b> Windshield (Solar) (W/Third Visor Frit, Acoustic Inter-layer) ..... | <b>43.2x62.5</b> |
| <b>DW01653<sup>acd</sup></b> Windshield (Solar) (W/Third Visor Frit) .....                       | <b>43.2x62.5</b> |
| <b>DD11136-37</b> Door F/R-L (Solar) .....   | <b>22.3x39.0</b> |
| <b>DD11140-41</b> Door R/R-L (Solar) .....   | <b>23.0x23.5</b> |
| <b>DD11138-39</b> Door R/R-L (Solar) (Export Only) .....   | <b>22.6x24.0</b> |
| <b>DR11712</b> Roof F (Solar) (Movable) .....  | <b>37.2x37.5</b> |
| <b>DR11779</b> Roof R (Solar) (Stationary) .....   |                  |
| <b>DQ11424-25<sup>e</sup></b> Quarter R-L (Encap)(Solar) (Chrome/Black Frame) (08-10) .....      | <b>16.3x26.3</b> |
| <b>DQ11152-53<sup>e</sup></b> Quarter R-L (Encap)(Solar) (Chrome Frame) (07) .....               | <b>16.3x26.3</b> |
| <b>DQ11150-51<sup>e</sup></b> Quarter R-L (Encap)(Solar) (Export Only, Chrome Frame) (07) .....  | <b>16.3x26.3</b> |
| <b>DV11144-45</b> Vent R/R-L (Solar) .....   | <b>10.0x17.8</b> |
| <b>DV11142-43</b> Vent R/R-L (Solar) (Export Only) .....   | <b>9.4x17.6</b>  |
| <b>DB11157<sup>c</sup></b> Back Window (Heated)(Solar) .....                                     | <b>27.8x56.1</b> |
| <b>DB11156<sup>c</sup></b> Back Window (Heated)(Solar) (Export Only) .....                       | <b>27.8x56.1</b> |

<sup>a</sup> Not On Production Vehicles  
<sup>b</sup> On Production Vehicles  
<sup>c</sup> Urethane,Dam,Primer - 2 Tubes  
<sup>d</sup> Fast-Cure Urethane/Dam/Primer - Quantity 2  
<sup>e</sup> Urethane,Dam,Primer - 1 Tube

**MKZ 4 Door Sedan ..... 2007-2011**

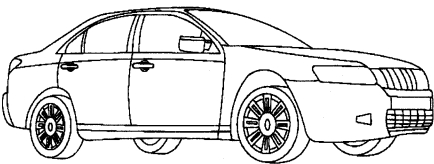

|   |                  |
|---|------------------|
| <b>DW01868<sup>ade</sup></b> Windshield (Solar) (W/Third Visor Frit, Aftermarket, Rain Sensor) (10-11) .....          | <b>42.0x60.0</b> |
| <b>DW01769<sup>bde</sup></b> Windshield (Solar) (W/Third Visor Frit, Acoustic Inter-layer, Rain Sensor) (10-11) ..... | <b>42.0x60.0</b> |
| <b>DW01768<sup>bde</sup></b> Windshield (Solar) (W/Third Visor Frit, Acoustic Inter-layer) (10-11) .....              | <b>42.0x60.0</b> |
| <b>DW01623<sup>cd</sup></b> Windshield (Solar) (W/Third Visor Frit) .....   | <b>42.0x58.5</b> |
| <b>DD10921-22</b> Door F/R-L (Solar) .....  | <b>22.0x39.0</b> |
| <b>DD10923-24</b> Door R/R-L (Solar) .....  | <b>20.3x27.0</b> |
| <b>DR11738</b> Roof (Solar) (From 11/04/2008) (09-11) .....   | <b>18.9x32.5</b> |
| <b>DR10981</b> Roof (Solar) (To 11/04/2008) (07-09) .....   | <b>18.9x32.5</b> |
| <b>DV10925-26</b> Vent R/R-L (Solar) .....  | <b>9.8x11.3</b>  |
| <b>DB11616<sup>d</sup></b> Back Window (Ant)(Heated)(Solar) (10-11) .....   | <b>32.4x54.0</b> |
| <b>DB10928<sup>d</sup></b> Back Window (Ant)(Heated)(Solar) (4 Leads) (07-09) .....                                   | <b>32.4x54.0</b> |

<sup>a</sup> Not On Production Vehicles  
<sup>b</sup> On Production Vehicles  
<sup>c</sup> Not On Production Vehicles 2010-2011  
<sup>d</sup> Urethane,Dam,Primer - 2 Tubes  
<sup>e</sup> Fast-Cure Urethane/Dam/Primer - Quantity 2

**Mark LT 4 Door Crew Cab ..... 2006-2008**

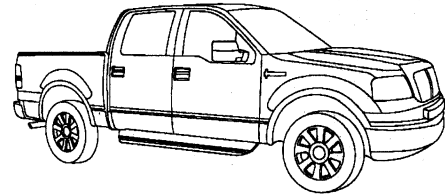

|   |                  |
|---|------------------|
| <b>DW01551<sup>adfg</sup></b> Windshield (Solar) (W/Third Visor Frit, Aftermarket) .....  | <b>37.2x70.7</b> |
| <b>DW01548<sup>efg</sup></b> Windshield (Solar) (W/Third Visor Frit) .....  | <b>37.2x70.7</b> |
| <b>DD10462-63</b> Door F/R-L (Solar) .....  | <b>26.4x27.1</b> |
| <b>DD10466-67</b> Door R/R-L (Solar) .....  | <b>26.4x27.7</b> |
| <b>DR09299</b> Roof (Solar) .....   | <b>18.0x40.0</b> |
| <b>DB10672</b> Back Window C (Solar) (OE, Power, Movable) .....   | <b>14.9x15.2</b> |
| <b>DY90114<sup>i</sup></b> Back Window (Slider)(Solar) (Aftermarket, 1 Panel Flush Fit, Manual) .....   | <b>18.5x65.5</b> |
| <b>DY90110<sup>i</sup></b> Back Window (Encap)(Slider)(Solar) (Black Frame, Aftermarket, Power, Bolt-In, 3 Panel Encapsulated) ...            | <b>18.5x65.5</b> |
| <b>DY90109<sup>i</sup></b> Back Window (Encap)(Slider)(Solar) (Black Frame, Aftermarket, Manual, Bolt-In, 3 Panel Encapsulated) .             | <b>18.5x65.5</b> |
| <b>DB11133<sup>bci</sup></b> Back Window (Encap)(Slider)(Solar) (OE, Manual & Power, W/O Center Sliding Glass, W/O Motor, Sub-Assembly) ..... | <b>18.5x65.5</b> |
| <b>DB10951<sup>i</sup></b> Back Window (Encap)(Slider)(Solar) (OE, Assembly, Power, 3 Piece) .....  | <b>18.5x65.5</b> |
| <b>DB10473<sup>b</sup></b> Back Window (Encap)(Heated)(Solar) (Stationary) ...  | <b>17.0x64.0</b> |

<sup>a</sup> May Require Two Person Installation  
<sup>b</sup> When Replacing a Power Slider, Plastic Insert # 4L3Z 15422B68 AA in the Lower Glass Run Channel Must Be Removed  
<sup>c</sup> Does Not Come With Center Slider  
<sup>d</sup> Not On Production Vehicles  
<sup>e</sup> On Production Vehicles  
<sup>f</sup> Urethane,Dam,Primer - 2 Tubes  
<sup>g</sup> Fast-Cure Urethane/Dam/Primer - Quantity 2  
<sup>h</sup> Foam Core Butyl Tape - Quantity 1.5  
<sup>i</sup> Foam Core Butyl Tape - Quantity 2

**Navigator 4 Door Utility ..... 2007-2011**

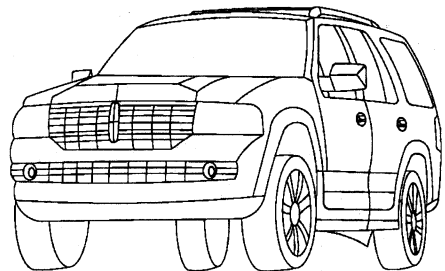

|   |                  |
|---|------------------|
| <b>DW01863<sup>abde</sup></b> Windshield (Solar) (W/Third Visor Frit, Aftermarket, Rain Sensor) (10-11) .....         | <b>37.3x66.4</b> |
| <b>DW01862<sup>abde</sup></b> Windshield (Solar) (W/Third Visor Frit, Aftermarket) (10-11) .....                      | <b>37.3x66.4</b> |
| <b>DW01861<sup>abde</sup></b> Windshield (Solar) (W/Third Visor Frit, Aftermarket, Rain Sensor) (09) .....            | <b>37.3x66.4</b> |
| <b>DW01860<sup>abde</sup></b> Windshield (Solar) (W/Third Visor Frit, Aftermarket) (08-09) .....                      | <b>37.3x66.4</b> |
| <b>DW01798<sup>acde</sup></b> Windshield (Solar) (W/Third Visor Frit, Acoustic Interlayer, Rain Sensor) (10-11) ..... | <b>37.3x66.4</b> |
| <b>DW01796<sup>ade</sup></b> Windshield (Solar) (W/Third Visor Frit, Acoustic Inter-layer) (10-11) .....              | <b>37.3x66.4</b> |
| <b>DW01755<sup>acd</sup></b> Windshield (Solar) (W/Third Visor Frit, Acoustic Interlayer, Rain Sensor) (09) .....     | <b>37.3x66.4</b> |
| <b>DW01742<sup>abd</sup></b> Windshield (Solar) (W/Third Visor Frit, Aftermarket) (07) .....                          | <b>37.3x66.4</b> |

**Navigator (cont.)**

|                            |  |           |
|----------------------------|--|-----------|
| DW01706 <sup>a c d e</sup> | Windshield (Solar) (W/Third Visor Frit, Acoustic Interlayer) (08-09) | 37.3x66.4 |
| DW01661 <sup>a c d e</sup> | Windshield (Solar) (W/Third Visor Frit, Acoustic Interlayer) (07)    | 37.3x66.4 |
| DD11125-26                 | Door F/R-L (Solar)   | 25.2x32.1 |
| DD11127-28                 | Door R/R-L (Solar)   | 24.2x26.8 |
| DR09299                    | Roof (Solar)   | 18.0x40.0 |
| DQ11106 <sup>f</sup>       | Quarter L (Encap)(Solar) (Movable)                                   | 23.1x43.4 |
| DQ11104 <sup>f</sup>       | Quarter L (Encap)(Solar) (Export Only, Movable) (07)                 | 23.1x43.4 |
| DQ11105 <sup>f</sup>       | Quarter R (Ant)(Encap)(Solar) (Movable)                              | 23.1x43.4 |
| DQ11103 <sup>f</sup>       | Quarter R (Ant)(Encap)(Solar) (Export Only, Movable) (07)            | 23.1x43.4 |
| DV10091-92 <sup>g</sup>    | Vent R/R-L (Solar)   | 9.6x21.9  |
| DB11158 <sup>a</sup>       | Back Window (Encap)(Heated)(3 Holes)(Solar)                          | 22.8x66.0 |

<sup>a</sup> May Require Two Person Installation  
<sup>b</sup> Not On Production Vehicles  
<sup>c</sup> On Production Vehicles  
<sup>d</sup> Urethane,Dam,Primer - 2 Tubes  
<sup>e</sup> Fast-Cure Urethane/Dam/Primer - Quantity 2  
<sup>f</sup> Foam Core Butyl Tape - Quantity 1.5  
<sup>g</sup> Urethane,Dam,Primer - 1 Tube

**Navigator 4 Door Utility..... 2006**

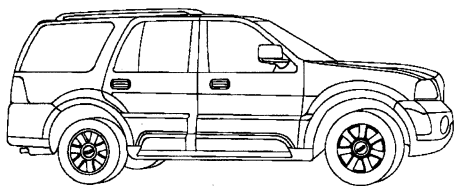

|                          |   |           |
|--------------------------|---|-----------|
| DW01582 <sup>a b c</sup> | Windshield (Solar) (W/Third Visor Frit)     | 37.3x66.4 |
| DD10015-16               | Door F/R-L (Solar) (Laminated, W/Bracket)   | 24.8x32.1 |
| DD09929-30               | Door R/R-L (Solar)                          | 24.2x26.3 |
| DR09299                  | Roof (Solar)                                | 18.0x40.0 |
| DQ09934 <sup>d</sup>     | Quarter L (Encap)(Solar) (Movable)          | 23.1x43.4 |
| DQ09933 <sup>d</sup>     | Quarter R (Ant)(Encap)(Solar) (Movable)     | 23.1x43.4 |
| DV10091-92 <sup>e</sup>  | Vent R/R-L (Solar)                          | 9.6x21.9  |
| DB09935                  | Back Window (Encap)(Heated)(3 Holes)(Solar) | 22.8x66.0 |

<sup>a</sup> May Require Two Person Installation  
<sup>b</sup> Urethane,Dam,Primer - 2 Tubes  
<sup>c</sup> Fast-Cure Urethane/Dam/Primer - Quantity 2  
<sup>d</sup> Foam Core Butyl Tape - Quantity 1.5  
<sup>e</sup> Urethane,Dam,Primer - 1 Tube

**Navigator L 4 Door Utility ..... 2007-2011**

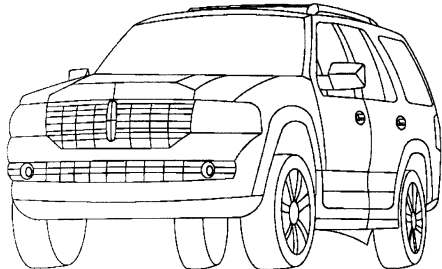

|                            |   |           |
|----------------------------|---|-----------|
| DW01863 <sup>a b d e</sup> | Windshield (Solar) (W/Third Visor Frit, Aftermarket, Rain Sensor) (10-11)         | 37.3x66.4 |
| DW01862 <sup>a b d e</sup> | Windshield (Solar) (W/Third Visor Frit, Aftermarket) (10-11)                      | 37.3x66.4 |
| DW01861 <sup>a b d e</sup> | Windshield (Solar) (W/Third Visor Frit, Aftermarket, Rain Sensor) (09)            | 37.3x66.4 |
| DW01860 <sup>a b d e</sup> | Windshield (Solar) (W/Third Visor Frit, Aftermarket) (08-09)                      | 37.3x66.4 |
| DW01798 <sup>a c d e</sup> | Windshield (Solar) (W/Third Visor Frit, Acoustic Interlayer, Rain Sensor) (10-11) | 37.3x66.4 |
| DW01796 <sup>a c d e</sup> | Windshield (Solar) (W/Third Visor Frit, Acoustic Interlayer) (10-11)              | 37.3x66.4 |
| DW01755 <sup>a c d e</sup> | Windshield (Solar) (W/Third Visor Frit, Acoustic Interlayer, Rain Sensor) (09)    | 37.3x66.4 |
| DW01742 <sup>a b d e</sup> | Windshield (Solar) (W/Third Visor Frit, Aftermarket) (07)                         | 37.3x66.4 |
| DW01706 <sup>a c d e</sup> | Windshield (Solar) (W/Third Visor Frit, Acoustic Interlayer) (08-09)              | 37.3x66.4 |
| DW01661 <sup>a c d e</sup> | Windshield (Solar) (W/Third Visor Frit, Acoustic Interlayer) (07)                 | 37.3x66.4 |
| DD11125-26                 | Door F/R-L (Solar)  | 25.2x32.1 |
| DD11127-28                 | Door R/R-L (Solar)  | 24.2x26.8 |
| DR09299                    | Roof (Solar)  | 18.0x40.0 |
| DQ11162 <sup>f</sup>       | Quarter L (Encap)(Solar) (Movable, LWB)   | 22.9x58.9 |
| DQ11161 <sup>f</sup>       | Quarter R (Ant)(Encap)(Solar) (Movable, LWB)                                      | 22.9x58.9 |
| DV10091-92 <sup>g</sup>    | Vent R/R-L (Solar)  | 9.6x21.9  |
| DB11158 <sup>a</sup>       | Back Window (Encap)(Heated)(3 Holes)(Solar)                                       | 22.8x66.0 |

<sup>a</sup> May Require Two Person Installation  
<sup>b</sup> Not On Production Vehicles  
<sup>c</sup> On Production Vehicles  
<sup>d</sup> Urethane,Dam,Primer - 2 Tubes  
<sup>e</sup> Fast-Cure Urethane/Dam/Primer - Quantity 2  
<sup>f</sup> Foam Core Butyl Tape - Quantity 2  
<sup>g</sup> Urethane,Dam,Primer - 1 Tube

**Town Car 4 Door Sedan ..... 2006-2011**

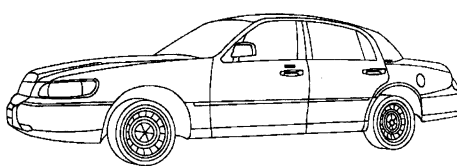

|                        |  |           |
|------------------------|--|-----------|
| DW01508 <sup>a b</sup> | Windshield (Solar) (Export Only, E-Mark)               | 36.9x65.3 |
| DW01462 <sup>a b</sup> | Windshield (Solar)                                     | 36.9x65.3 |
| DD09881-82             | Door F/R-L (2 Holes)(Solar) (OE, Lincoln Logo)         | 23.9x35.0 |
| DD10084-85             | Door R/R-L (Solar) (LWB)                               | 22.2x28.3 |
| DD09695-96             | Door R/R-L (Solar) (OE, Lincoln Logo)                  | 22.4x28.3 |
| DR10950                | Roof (Solar)   |           |
| DV10086-87             | Vent R/R-L (Solar) (LWB)                               | 11.4x17.1 |
| DV09339-40             | Vent R/R-L (Solar)                                     | 5.5x15.6  |
| DB10544 <sup>c</sup>   | Back Window (Ant)(Heated)(Solar) (Export Only, E-Mark) | 18.9x57.4 |
| DB10543 <sup>c</sup>   | Back Window (Ant)(Heated)(Solar)                       | 18.9x57.4 |

<sup>a</sup> Urethane,Dam,Primer - 2 Tubes  
<sup>b</sup> Fast-Cure Urethane/Dam/Primer - Quantity 2  
<sup>c</sup> Urethane,Dam,Primer - 1.5 Tubes

**Zephyr 4 Door Sedan ..... 2006**

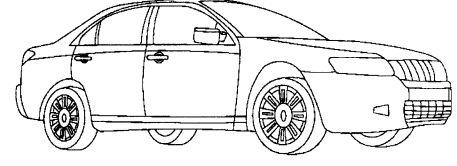

|                        |  |           |
|------------------------|--|-----------|
| DW01623 <sup>a b</sup> | Windshield (Solar) (W/Third Visor Frit)    | 42.0x58.5 |
| DD10921-22             | Door F/R-L (Solar)                         | 22.0x39.0 |
| DD10923-24             | Door R/R-L (Solar)                         | 20.3x27.0 |
| DR10981                | Roof (Solar)                               | 18.9x32.5 |
| DV10925-26             | Vent R/R-L (Solar)                         | 9.8x11.3  |
| DB10928 <sup>a</sup>   | Back Window (Ant)(Heated)(Solar) (4 Leads) | 32.4x54.0 |

<sup>a</sup> Urethane,Dam,Primer - 2 Tubes  
<sup>b</sup> Fast-Cure Urethane/Dam/Primer - Quantity 2

**Mazda**  
**2 4 Door Hatchback..... 2011**

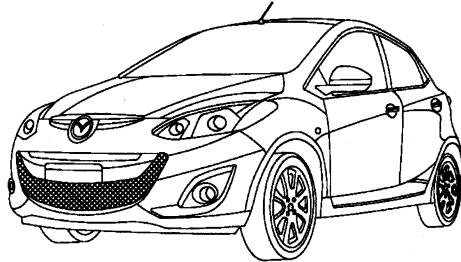

|   |                  |
|---|------------------|
| <b>FW03301<sup>a b d</sup></b> Windshield (W/Third Visor Frit, Rain Sensor) ..... | <b>37.5x51.0</b> |
| <b>FW03300<sup>a b</sup></b> Windshield (W/Third Visor Frit) .....                | <b>37.5x51.0</b> |
| <b>FD24768-69</b> Door F/R-L .....  | <b>19.0x33.0</b> |
| <b>FD24770-71</b> Door R/R-L .....  | <b>18.0x25.5</b> |
| <b>FB24772<sup>c</sup></b> Back Window (Heated) .....                             | <b>21.0x51.0</b> |
| <sup>a</sup> Urethane,Dam,Primer - 2 Tubes  |                  |
| <sup>b</sup> Fast-Cure Urethane/Dam/Primer - Quantity 2                           |                  |
| <sup>c</sup> Urethane,Dam,Primer - 1.5 Tubes                                      |                  |
| <sup>d</sup> Rain Sensor Kit  |                  |

**3 4 Door Hatchback..... 2010-2011**

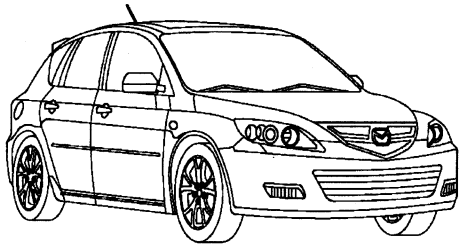

|  |                  |
|--|------------------|
| <b>FW03088<sup>a b d</sup></b> Windshield (Rain Sensor) .....  | <b>40.0x56.0</b> |
| <b>FW03087<sup>a b</sup></b> Windshield .....                  | <b>40.0x56.0</b> |
| <b>FD24234-35</b> Door F/R-L .....                             | <b>20.0x33.5</b> |
| <b>FD24241-42</b> Door R/R-L .....                             | <b>18.0x20.0</b> |
| <b>FQ24245-46<sup>e</sup></b> Quarter R-L (Encap) .....        | <b>13.5x14.0</b> |
| <b>FV24243-44</b> Vent R/R-L .....                             | <b>6.5x10.5</b>  |
| <b>FB24247<sup>c</sup></b> Back Window (Heated)(1 Holes) ..... | <b>21.0x47.5</b> |
| <sup>a</sup> Urethane,Dam,Primer - 2 Tubes                     |                  |
| <sup>b</sup> Fast-Cure Urethane/Dam/Primer - Quantity 2        |                  |
| <sup>c</sup> Urethane,Dam,Primer - 1.5 Tubes                   |                  |
| <sup>d</sup> Rain Sensor Kit                                   |                  |
| <sup>e</sup> Urethane,Dam,Primer - 1 Tube                      |                  |

**3 4 Door Hatchback..... 2006-2009**

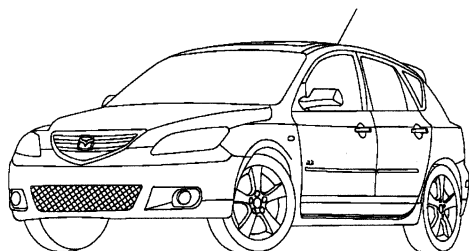

|   |                  |
|---|------------------|
| <b>FW02464<sup>a b</sup></b> Windshield (Rain Sensor) ..... | <b>37.0x57.5</b> |
| <b>FW02461<sup>a b</sup></b> Windshield .....               | <b>37.0x57.5</b> |

**3 (cont.)**

|  |                  |
|--|------------------|
| <b>FD22280-81</b> Door F/R-L .....                                       | <b>18.0x33.5</b> |
| <b>FD22287-88</b> Door R/R-L .....                                       | <b>18.0x26.0</b> |
| <b>FQ22289-90<sup>d</sup></b> Quarter R-L (Encap) .....                  | <b>15.0x16.0</b> |
| <b>FB22291<sup>c</sup></b> Back Window (Heated)(1 Holes) (W/Wiper) ..... | <b>24.0x46.3</b> |
| <sup>a</sup> Urethane,Dam,Primer - 2 Tubes                               |                  |
| <sup>b</sup> Fast-Cure Urethane/Dam/Primer - Quantity 2                  |                  |
| <sup>c</sup> Urethane,Dam,Primer - 1.5 Tubes                             |                  |
| <sup>d</sup> Urethane,Dam,Primer - 1 Tube                                |                  |

**3 4 Door Sedan..... 2010-2011**

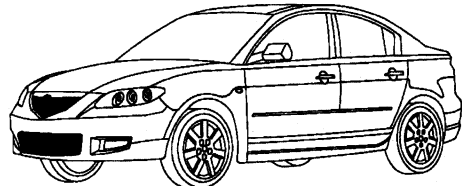

|   |                  |
|---|------------------|
| <b>FW03088<sup>a b d</sup></b> Windshield (Rain Sensor) ..... | <b>40.0x56.0</b> |
| <b>FW03087<sup>a b</sup></b> Windshield .....                 | <b>40.0x56.0</b> |
| <b>FD24234-35</b> Door F/R-L .....                            | <b>20.0x33.5</b> |
| <b>FD24236-37</b> Door R/R-L .....                            | <b>18.0x22.0</b> |
| <b>FV24238-39</b> Vent R/R-L .....                            | <b>9.0x11.0</b>  |
| <b>FB24240<sup>c</sup></b> Back Window (Ant)(Heated) .....    | <b>29.0x48.0</b> |
| <sup>a</sup> Urethane,Dam,Primer - 2 Tubes                    |                  |
| <sup>b</sup> Fast-Cure Urethane/Dam/Primer - Quantity 2       |                  |
| <sup>c</sup> Urethane,Dam,Primer - 1.5 Tubes                  |                  |
| <sup>d</sup> Rain Sensor Kit                                  |                  |

**3 4 Door Sedan..... 2006-2009**

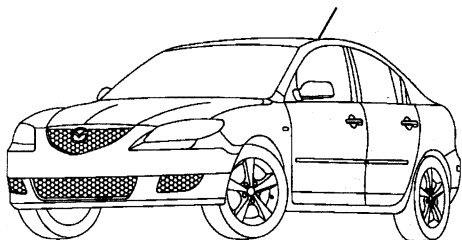

|   |                  |
|---|------------------|
| <b>FW02464<sup>a b</sup></b> Windshield (Rain Sensor) .....         | <b>37.0x57.5</b> |
| <b>FW02461<sup>a b</sup></b> Windshield .....                       | <b>37.0x57.5</b> |
| <b>FD22280-81</b> Door F/R-L .....                                  | <b>18.0x33.5</b> |
| <b>FD22282-83</b> Door R/R-L .....                                  | <b>18.0x24.5</b> |
| <b>FV22284-85</b> Vent R/R-L .....                                  | <b>6.8x11.0</b>  |
| <b>FB22286<sup>c</sup></b> Back Window (Heated) (PAAS System) ..... | <b>29.0x44.5</b> |
| <sup>a</sup> Urethane,Dam,Primer - 2 Tubes                          |                  |
| <sup>b</sup> Fast-Cure Urethane/Dam/Primer - Quantity 2             |                  |
| <sup>c</sup> Urethane,Dam,Primer - 1.5 Tubes                        |                  |

**5 Mini Van ..... 2006-2010**

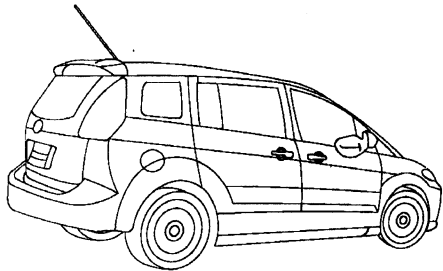

|  |                  |
|--|------------------|
| <b>FW02597<sup>a b</sup></b> Windshield (Rain Sensor) .....              | <b>38.8x56.1</b> |
| <b>FW02596<sup>a b</sup></b> Windshield .....                            | <b>38.8x56.1</b> |
| <b>FD22748-49</b> Door F/R-L (2 Holes) .....                             | <b>23.0x33.0</b> |
| <b>FD22750-51</b> Door R/R-L (1 Holes)(Solar) (Sliding Cargo Door) ..... | <b>20.5x26.8</b> |
| <b>FQ22754-55<sup>d</sup></b> Quarter R-L (Solar) .....                  | <b>15.5x21.5</b> |
| <b>FV22746-47</b> Vent F/R-L .....                                       | <b>9.0x14.5</b>  |
| <b>FV22752-53</b> Vent R/R-L (Solar) .....                               | <b>9.0x14.5</b>  |
| <b>FB22756<sup>c</sup></b> Back Window (1 Holes)(Solar) .....            | <b>19.0x48.0</b> |

<sup>a</sup> Urethane,Dam,Primer - 2 Tubes  
<sup>b</sup> Fast-Cure Urethane/Dam/Primer - Quantity 2  
<sup>c</sup> Urethane,Dam,Primer - 1.5 Tubes  
<sup>d</sup> Urethane,Dam,Primer - 1 Tube

**6 4 Door Hatchback ..... 2006-2008**

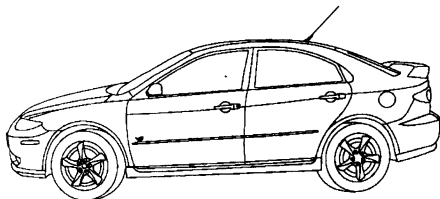

|   |                  |
|---|------------------|
| <b>FW02308<sup>a b</sup></b> Windshield .....         | <b>37.0x56.0</b> |
| <b>FD21680-81</b> Door F/R-L (1 Holes) .....          | <b>19.0x34.0</b> |
| <b>FD22318-19</b> Door R/R-L (1 Holes) .....          | <b>20.8x27.5</b> |
| <b>FV22320-21</b> Vent R/R-L .....                    | <b>9.5x10.0</b>  |
| <b>FB22324<sup>a</sup></b> Back Window (Heated) ..... | <b>32.0x51.0</b> |

<sup>a</sup> Urethane,Dam,Primer - 2 Tubes  
<sup>b</sup> Fast-Cure Urethane/Dam/Primer - Quantity 2

**6 4 Door Sedan ..... 2009-2011**

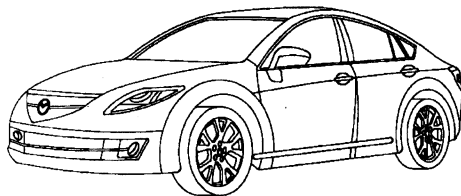

|  |                  |
|--|------------------|
| <b>FW03265<sup>a c d</sup></b> Windshield (Solar) (Aftermarket, Rain Sensor) .....         | <b>40.3x55.7</b> |
| <b>FW02982<sup>b c d</sup></b> Windshield (Solar) (Acoustic Interlayer, Rain Sensor) ..... | <b>40.3x55.7</b> |
| <b>FW02981<sup>b c d</sup></b> Windshield (Solar) .....                                    | <b>40.3x55.7</b> |
| <b>FD23969-70</b> Door F/R-L (Solar) .....   | <b>19.0x35.0</b> |
| <b>FD23971-72</b> Door R/R-L (Solar) .....   | <b>19.0x27.0</b> |
| <b>FV23973-74</b> Vent R/R-L (Solar) .....   | <b>7.5x10.0</b>  |
| <b>FB23975<sup>c</sup></b> Back Window (Heated)(Solar) .....                               | <b>34.0x51.0</b> |

<sup>a</sup> Not On Production Vehicles  
<sup>b</sup> On Production Vehicles  
<sup>c</sup> Urethane,Dam,Primer - 2 Tubes  
<sup>d</sup> Fast-Cure Urethane/Dam/Primer - Quantity 2

**6 4 Door Sedan ..... 2006-2008**

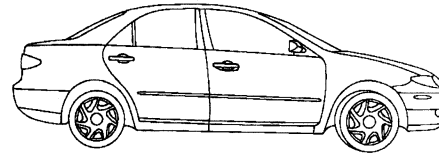

|  |                  |
|--|------------------|
| <b>FW02698<sup>a b</sup></b> Windshield (Mazdaspeed) (06-07) ..... | <b>37.0x56.0</b> |
| <b>FW02308<sup>a b</sup></b> Windshield .....                      | <b>37.0x56.0</b> |
| <b>FD21680-81</b> Door F/R-L (1 Holes) .....                       | <b>19.0x34.0</b> |
| <b>FD21682-83</b> Door R/R-L (1 Holes) .....                       | <b>19.0x25.3</b> |
| <b>FV21684-85</b> Vent R/R-L .....                                 | <b>8.2x 9.2</b>  |
| <b>FB22913<sup>a</sup></b> Back Window (Heated) .....              | <b>31.7x50.2</b> |

<sup>a</sup> Urethane,Dam,Primer - 2 Tubes  
<sup>b</sup> Fast-Cure Urethane/Dam/Primer - Quantity 2

**6 4 Door Station Wagon ..... 2006-2008**

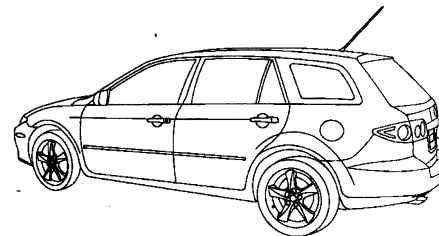

|   |                  |
|---|------------------|
| <b>FW02308<sup>a b</sup></b> Windshield .....                     | <b>37.0x56.0</b> |
| <b>FD21680-81</b> Door F/R-L (1 Holes) .....                      | <b>19.0x34.0</b> |
| <b>FD22325-26</b> Door R/R-L (1 Holes) .....                      | <b>21.5x29.0</b> |
| <b>FQ22329-30<sup>d</sup></b> Quarter R-L (Encap) .....           | <b>15.5x30.0</b> |
| <b>FV22327-28</b> Vent R/R-L .....                                | <b>9.5x14.0</b>  |
| <b>FB22332<sup>c</sup></b> Back Window (Heated) (W/Spoiler) ..... | <b>19.5x53.0</b> |
| <b>FB22331<sup>c</sup></b> Back Window (Heated) .....             | <b>19.5x53.0</b> |

<sup>a</sup> Urethane,Dam,Primer - 2 Tubes  
<sup>b</sup> Fast-Cure Urethane/Dam/Primer - Quantity 2  
<sup>c</sup> Urethane,Dam,Primer - 1.5 Tubes  
<sup>d</sup> Urethane,Dam,Primer - 1 Tube

**B2300 Pickup 2 Door Standard Cab ..... 2006-2009**

**B3000 Pickup 2 Door Standard Cab ..... 2006-2009**

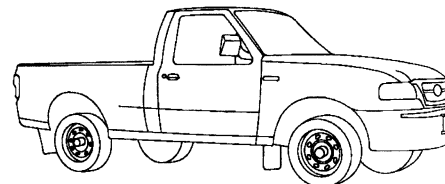

|   |                  |
|---|------------------|
| <b>DW01317<sup>a b</sup></b> Windshield (Solar) .....   | <b>28.4x56.4</b> |
| <b>DD09286-87</b> Door F/R-L (Solar) .....  | <b>22.0x30.0</b> |
| <b>DB10801</b> Back Window C (Solar) (OE, Movable) .....  | <b>14.1x14.8</b> |
| <b>DY90071<sup>c</sup></b> Back Window (Encap)(Slider)(Solar) (Urethane, Aftermarket, 3 Panel Encapsulated) ..... | <b>17.8x51.8</b> |
| <b>DY90040<sup>c</sup></b> Back Window (Encap)(Slider) (Urethane, Aftermarket, Power, 3 Panel Encapsulated) ..... | <b>17.8x51.8</b> |
| <b>DY90039<sup>c</sup></b> Back Window (Encap)(Slider) (Urethane, Aftermarket, 4 Panel Encapsulated) .....        | <b>17.8x51.8</b> |
| <b>DB10883<sup>d</sup></b> Back Window (Encap)(Slider)(Solar) (OE, Assembly) .....                                | <b>17.8x51.8</b> |
| <b>DB10882<sup>d</sup></b> Back Window (Encap)(Solar) (Stationary) .....  | <b>15.0x49.0</b> |

<sup>a</sup> Urethane,Dam,Primer - 2 Tubes  
<sup>b</sup> Fast-Cure Urethane/Dam/Primer - Quantity 2

|  |                  |
|--|------------------|
| <b>B2300 Pickup</b> .....  | <b>(cont.)</b>   |
| <sup>c</sup> Urethane,Dam,Primer - 1.5 Tubes<br><sup>d</sup> Foam Core Butyl Tape - Quantity 1.5 |                  |
| <b>B3000 Pickup</b> 2 Door Extended Cab .....  | <b>2006-2009</b> |
| <b>B4000 Pickup</b> 2 Door Extended Cab .....  | <b>2006-2009</b> |

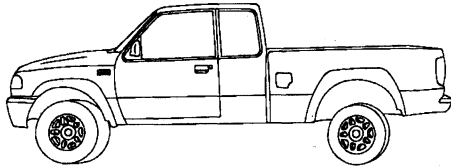

|   |                  |
|---|------------------|
| <b>DW01317<sup>a b</sup></b> Windshield (Solar) .....   | <b>28.4x56.4</b> |
| <b>DD09286-87</b> Door F/R-L (Solar) .....  | <b>22.0x30.0</b> |
| <b>DQ09411-12<sup>c</sup></b> Quarter R-L (Encap)(Solar) (One-Sided Rim Encapsulation, Rear Access Door) .....    | <b>15.0x18.5</b> |
| <b>DQ09345-46<sup>e</sup></b> Quarter R-L (Solar) (Stationary) .....  | <b>14.8x16.9</b> |
| <b>DB10801</b> Back Window C (Solar) (OE, Movable) .....  | <b>14.1x14.8</b> |
| <b>DY90071<sup>c</sup></b> Back Window (Encap)(Slider)(Solar) (Urethane, Aftermarket, 3 Panel Encapsulated) ..... | <b>17.8x51.8</b> |
| <b>DY90040<sup>c</sup></b> Back Window (Encap)(Slider) (Urethane, Aftermarket, Power, 3 Panel Encapsulated) ..... | <b>17.8x51.8</b> |
| <b>DY90039<sup>c</sup></b> Back Window (Encap)(Slider) (Urethane, Aftermarket, 4 Panel Encapsulated) .....        | <b>17.8x51.8</b> |
| <b>DB10883<sup>d</sup></b> Back Window (Encap)(Slider)(Solar) (OE, Assembly) .....                                | <b>17.8x51.8</b> |
| <b>DB10882<sup>d</sup></b> Back Window (Encap)(Solar) (Stationary) .....  | <b>15.0x49.0</b> |

- <sup>a</sup> Urethane,Dam,Primer - 2 Tubes
- <sup>b</sup> Fast-Cure Urethane/Dam/Primer - Quantity 2
- <sup>c</sup> Urethane,Dam,Primer - 1.5 Tubes
- <sup>d</sup> Foam Core Butyl Tape - Quantity 1.5
- <sup>e</sup> Foam Core Butyl Tape - Quantity 1

**CX-7 4 Door Utility**..... **2007-2011**

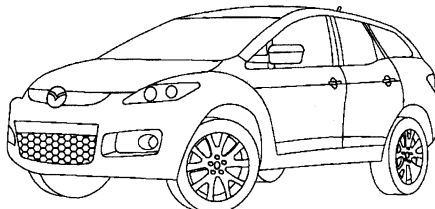

|   |                  |
|---|------------------|
| <b>FW03219<sup>a b d</sup></b> Windshield (W/Third Visor Frit, Rain Sensor) (10-11) ..... | <b>43.0x59.0</b> |
| <b>FW02656<sup>a b</sup></b> Windshield (W/Third Visor Frit) .....                        | <b>43.0x59.0</b> |
| <b>FD23089-90</b> Door F/R-L (2 Holes) .....  | <b>24.0x37.0</b> |
| <b>FD23091-92</b> Door R/R-L (1 Holes)(Solar) .....                                       | <b>21.3x25.0</b> |
| <b>FQ23093-94<sup>c</sup></b> Quarter R-L (Encap)(Solar) .....                            | <b>15.0x28.0</b> |
| <b>FV23087-88<sup>c</sup></b> Vent F/R-L (Encap) .....                                    | <b>9.0x12.0</b>  |
| <b>FB23095<sup>c</sup></b> Back Window (Heated)(1 Holes)(Solar) .....                     | <b>23.0x53.0</b> |

- <sup>a</sup> Urethane,Dam,Primer - 2 Tubes
- <sup>b</sup> Fast-Cure Urethane/Dam/Primer - Quantity 2
- <sup>c</sup> Urethane,Dam,Primer - 1.5 Tubes
- <sup>d</sup> Rain Sensor Kit
- <sup>e</sup> Urethane,Dam,Primer - 1 Tube

**CX-9 4 Door Utility**..... **2007-2011**

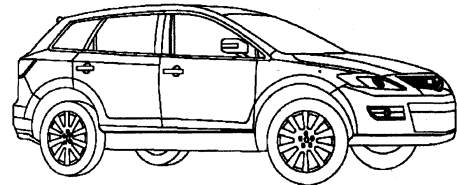

|  |                  |
|--|------------------|
| <b>FW02755<sup>a b</sup></b> Windshield (W/Third Visor Frit, Acoustic Interlayer, Rain Sensor) ..... | <b>42.0x60.0</b> |
| <b>FW02754<sup>a b</sup></b> Windshield (W/Third Visor Frit, Acoustic Interlayer) .....              | <b>42.0x60.0</b> |
| <b>FW02753<sup>a b</sup></b> Windshield (W/Third Visor Frit, Rain Sensor) .....                      | <b>42.0x60.0</b> |
| <b>FW02752<sup>a b</sup></b> Windshield (W/Third Visor Frit) .....                                   | <b>42.0x60.0</b> |
| <b>FD23451-52</b> Door F/R-L (Solar) .....   | <b>22.5x38.3</b> |
| <b>FD23453-54</b> Door R/R-L (Solar) .....   | <b>20.5x34.5</b> |
| <b>FQ23455-56<sup>d</sup></b> Quarter R-L (Encap)(Solar) .....                                       | <b>14.0x21.0</b> |
| <b>FB23457<sup>c</sup></b> Back Window (Heated)(1 Holes)(Solar) .....                                | <b>23.0x55.0</b> |

- <sup>a</sup> Urethane,Dam,Primer - 2 Tubes
- <sup>b</sup> Fast-Cure Urethane/Dam/Primer - Quantity 2
- <sup>c</sup> Urethane,Dam,Primer - 1.5 Tubes
- <sup>d</sup> Urethane,Dam,Primer - 1 Tube

**MPV Mini Van**..... **2006**

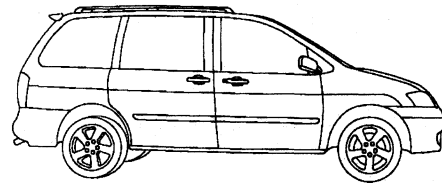

|  |                  |
|--|------------------|
| <b>FW02505<sup>a b c</sup></b> Windshield .....                | <b>41.9x59.0</b> |
| <b>FD20823-24</b> Door F/R-L (2 Holes) .....                   | <b>24.5x39.0</b> |
| <b>FD20825-26</b> Door R/R-L (2 Holes)(Solar) .....            | <b>27.5x37.0</b> |
| <b>FQ20827-28</b> Quarter R-L (1 Holes)(Solar) (Movable) ..... | <b>21.5x32.8</b> |
| <b>FB20829<sup>b</sup></b> Back Window (Heated)(Solar) .....   | <b>23.0x62.0</b> |

- <sup>a</sup> May Require Two Person Installation
- <sup>b</sup> Urethane,Dam,Primer - 2 Tubes
- <sup>c</sup> Fast-Cure Urethane/Dam/Primer - Quantity 2

**MX-5 Miata 2 Door Convertible**..... **2006-2011**

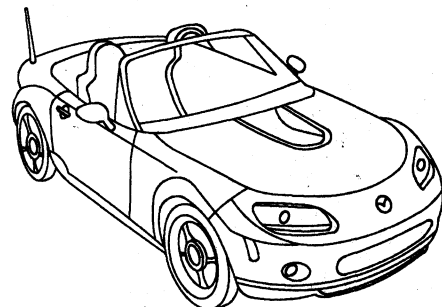

|   |                  |
|---|------------------|
| <b>FW03163<sup>a b</sup></b> Windshield (Electrochromic Mirror) (09-11) ..... | <b>27.5x57.2</b> |
| <b>FW03162<sup>a b</sup></b> Windshield (09-11) .....                         | <b>27.5x57.2</b> |
| <b>FW02594<sup>a b</sup></b> Windshield (06-08) .....                         | <b>27.5x57.2</b> |
| <b>FD22734-35</b> Door F/R-L (6 Holes) .....                                  | <b>20.5x31.8</b> |
| <b>FV22732-33</b> Vent F/R-L .....  | <b>7.0x 8.5</b>  |
| <b>FB23988<sup>c</sup></b> Back Window (Heated) (Retractable Hardtop) .....   | <b>17.0x46.0</b> |
| <b>FB22736<sup>d</sup></b> Back Window (Heated) (Removable Hardtop) .....     | <b>14.0x33.5</b> |

- <sup>a</sup> Urethane,Dam,Primer - 2 Tubes
- <sup>b</sup> Fast-Cure Urethane/Dam/Primer - Quantity 2

**MX-5 Miata** (cont.)

<sup>c</sup> Urethane,Dam,Primer - 1.5 Tubes  
<sup>d</sup> Urethane,Dam,Primer - 1 Tube

**RX8 2 Door Coupe** ..... 2009-2011

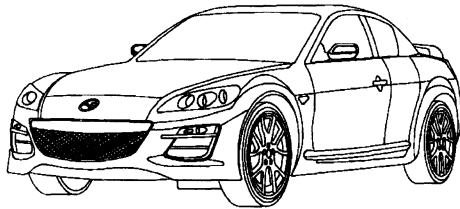

|   |                  |
|---|------------------|
| <b>FW02984<sup>a b d</sup></b> Windshield (W/Third Visor Frit, Rain Sensor) ..... | <b>35.0x57.0</b> |
| <b>FW02983<sup>a b</sup></b> Windshield (W/Third Visor Frit) .....                | <b>35.0x57.0</b> |
| <b>FD23976-77</b> Door F/R-L (Solar) .....  | <b>16.0x29.0</b> |
| <b>FQ23978-79</b> Quarter R-L (Solar) (Rear Access Door) .....                    | <b>13.0x20.0</b> |
| <b>FB23980<sup>c</sup></b> Back Window (Heated)(Solar) .....                      | <b>24.0x50.0</b> |

<sup>a</sup> Urethane,Dam,Primer - 2 Tubes  
<sup>b</sup> Fast-Cure Urethane/Dam/Primer - Quantity 2  
<sup>c</sup> Urethane,Dam,Primer - 1.5 Tubes  
<sup>d</sup> Rain Sensor Kit

**RX8 2 Door Coupe** ..... 2006-2008

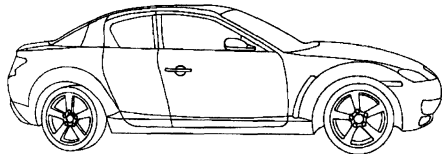

|   |                  |
|---|------------------|
| <b>FW02433<sup>a b</sup></b> Windshield (Electrochromic Mirror) ..... | <b>35.5x53.6</b> |
| <b>FW02396<sup>a b</sup></b> Windshield .....                         | <b>35.5x53.6</b> |
| <b>FD21980-81</b> Door F/R-L (Solar) .....                            | <b>17.0x34.1</b> |
| <b>FQ21982-83</b> Quarter R-L (Encap)(1 Holes)(Solar) (Movable) ..... | <b>13.2x18.2</b> |
| <b>FB21984<sup>a</sup></b> Back Window (Heated)(Solar) .....          | <b>24.0x59.3</b> |

<sup>a</sup> Urethane,Dam,Primer - 2 Tubes  
<sup>b</sup> Fast-Cure Urethane/Dam/Primer - Quantity 2

**Tribute 4 Door Utility**..... 2008-2011

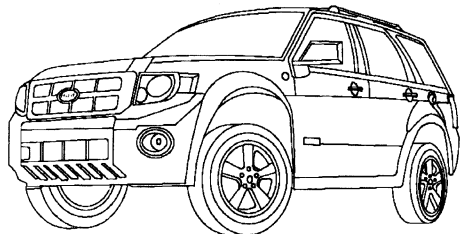

|  |                  |
|--|------------------|
| <b>DW01795<sup>a c d</sup></b> Windshield (Solar) (W/Third Visor Frit, Aftermarket) .....          | <b>33.8x55.5</b> |
| <b>DW01684<sup>b c d</sup></b> Windshield (Solar) (W/Third Visor Frit, Acoustic Inter-layer) ..... | <b>33.8x55.5</b> |
| <b>DD11259-60</b> Door F/R-L (Solar) .....   | <b>21.3x32.8</b> |
| <b>DD11261-62</b> Door R/R-L (Solar) .....   | <b>19.9x28.4</b> |
| <b>DR11711</b> Roof (Encap)(Solar) (09-11) .....   | <b>19.1x34.5</b> |
| <b>DR09758</b> Roof (Encap)(Solar) (08) .....  | <b>19.1x34.5</b> |
| <b>DQ11263-64<sup>c</sup></b> Quarter R-L (Solar) .....  | <b>16.9x29.4</b> |
| <b>DB11913</b> Back Window (Heated)(5 Holes)(Solar) (11) .....                                     | <b>18.8x50.4</b> |
| <b>DB11266</b> Back Window (Heated)(3 Holes)(Solar) (08-10) .....                                  | <b>18.8x50.4</b> |

<sup>a</sup> Not On Production Vehicles  
<sup>b</sup> On Production Vehicles

**Tribute** (cont.)

<sup>c</sup> Urethane,Dam,Primer - 2 Tubes  
<sup>d</sup> Fast-Cure Urethane/Dam/Primer - Quantity 2  
<sup>e</sup> Urethane,Dam,Primer - 1 Tube

**Tribute HYBRID 4 Door Utility** ..... 2008-2011

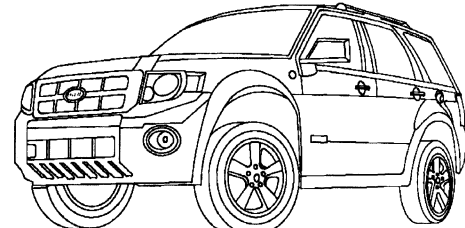

|  |                  |
|--|------------------|
| <b>DW01795<sup>a c d</sup></b> Windshield (Solar) (W/Third Visor Frit, Aftermarket) .....          | <b>33.8x55.5</b> |
| <b>DW01684<sup>b c d</sup></b> Windshield (Solar) (W/Third Visor Frit, Acoustic Inter-layer) ..... | <b>33.8x55.5</b> |
| <b>DD11259-60</b> Door F/R-L (Solar) .....   | <b>21.3x32.8</b> |
| <b>DD11261-62</b> Door R/R-L (Solar) .....   | <b>19.9x28.4</b> |
| <b>DR11711</b> Roof (Encap)(Solar) (09-11) .....   | <b>19.1x34.5</b> |
| <b>DR09758</b> Roof (Encap)(Solar) (08) .....  | <b>19.1x34.5</b> |
| <b>DQ11265<sup>e</sup></b> Quarter L (Solar) (Hybrid, W/Battery Vent) .....                        | <b>16.9x29.4</b> |
| <b>DQ11263<sup>e</sup></b> Quarter R (Solar) .....   | <b>16.9x29.4</b> |
| <b>DB11913</b> Back Window (Heated)(5 Holes)(Solar) (11) .....                                     | <b>18.8x50.4</b> |
| <b>DB11266</b> Back Window (Heated)(3 Holes)(Solar) (08-10) .....                                  | <b>18.8x50.4</b> |

<sup>a</sup> Not On Production Vehicles  
<sup>b</sup> On Production Vehicles  
<sup>c</sup> Urethane,Dam,Primer - 2 Tubes  
<sup>d</sup> Fast-Cure Urethane/Dam/Primer - Quantity 2  
<sup>e</sup> Urethane,Dam,Primer - 1 Tube

**Tribute 4 Door Utility** ..... 2006

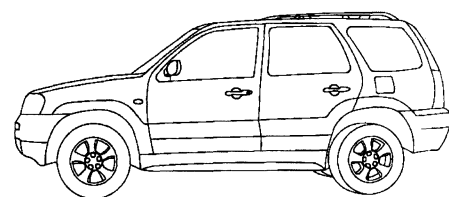

|  |                  |
|--|------------------|
| <b>DW01579<sup>a b</sup></b> Windshield (Solar) (W/Third Visor Frit) ..... | <b>33.8x55.5</b> |
| <b>DD09751-52</b> Door F/R-L (2 Holes)(Solar) .....                        | <b>21.3x33.7</b> |
| <b>DD09796-97</b> Door R/R-L (2 Holes)(Solar) .....                        | <b>20.0x26.5</b> |
| <b>DR09758</b> Roof (Encap)(Solar) .....                                   | <b>19.1x34.5</b> |
| <b>DQ10053-54<sup>c</sup></b> Quarter R-L (Solar) .....                    | <b>18.3x29.1</b> |
| <b>DB10274</b> Back Window (Heated)(8 Holes)(Solar) .....                  | <b>20.0x51.5</b> |

<sup>a</sup> Urethane,Dam,Primer - 2 Tubes  
<sup>b</sup> Fast-Cure Urethane/Dam/Primer - Quantity 2  
<sup>c</sup> Urethane,Dam,Primer - 1 Tube

**Mercedes Benz**

**A160 4 Door Hatchback (MEXICO Only)** ..... 2006-2008

|  |                  |
|--|------------------|
| <b>FW02695<sup>a</sup></b> Windshield (Solar) (Rain/Light Sensor) .....    | <b>35.2x54.1</b> |
| <b>FW02177<sup>a</sup></b> Windshield (Solar) .....                        | <b>35.2x54.1</b> |
| <b>FD21002-03</b> Door F/R-L (Mexico Only) .....                           |                  |
| <b>FD21004-05</b> Door R/R-L (Mexico Only) .....                           |                  |
| <b>FQ21008-09<sup>b</sup></b> Quarter R-L (Encap) (Mexico Only) .....      |                  |
| <b>FV21000-01<sup>b</sup></b> Vent F/R-L (Mexico Only) .....               |                  |
| <b>FV21006-07</b> Vent R/R-L (Mexico Only) .....                           |                  |
| <b>FB21010<sup>b</sup></b> Back Window (Heated)(Solar) (Mexico Only) ..... |                  |

**A160 (cont.)**

<sup>a</sup> High Modulus Non-Conductive Urethane,Dam,Primer - 2 Tubes  
<sup>b</sup> High Modulus Non-Conductive Urethane,Dam,Primer - 1.5 Tubes

**B200 4 Door Hatchback ..... 2006-2011**

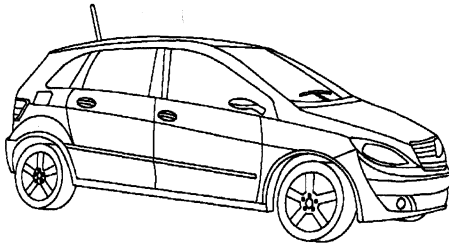

**FW02961<sup>a</sup>** Windshield (Solar) (Rain Sensor) ..... 35.2x54.1  
**FW02695<sup>a</sup>** Windshield (Solar) (Rain/Light Sensor) ..... 35.2x54.1  
**FW02177<sup>a</sup>** Windshield (Solar) ..... 35.2x54.1  
**FD23229-30** Door F/R-L (Solar) .....  
**FD23231-32** Door R/R-L (Solar) ..... 21.3x28.4  
**FQ23233-34<sup>c</sup>** Quarter R-L (Encap)(Solar) ..... 15.2x15.6  
**FB23938<sup>b</sup>** Back Window (Ant)(Heated)(Solar) .....  
**FB23235<sup>b</sup>** Back Window (Heated)(Solar) .....  
<sup>a</sup> High Modulus Non-Conductive Urethane,Dam,Primer - 2 Tubes  
<sup>b</sup> High Modulus Non-Conductive Urethane,Dam,Primer - 1.5 Tubes  
<sup>c</sup> High Modulus Non-Conductive Urethane,Dam,Primer - 1 Tube

**C200 4 Door Sedan ..... 2010-2011**  
**C280 4 Door Sedan ..... 2008-2009**

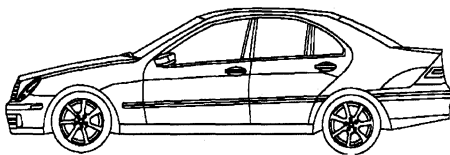

**FW02845<sup>a,b</sup>** Windshield (Encap)(Solar) (W/Third Visor Frit, Rain Sensor) (08-11) ..... 34.0x58.5  
**FD23569-70** Door F/R-L (Solar) (08-11) ..... 21.5x34.8  
**FD23571-72** Door R/R-L (Solar) (08-11) ..... 20.3x23.0  
**FV23573-74** Vent R/R-L (Encap)(Solar) (08-11) ..... 11.5x13.5  
**FB23575<sup>c</sup>** Back Window (Ant)(Heated)(Solar) (08-11) ..... 28.0x52.0  
<sup>a</sup> High Modulus Non-Conductive Urethane,Dam,Primer - 2 Tubes  
<sup>b</sup> Rain Sensor Kit  
<sup>c</sup> High Modulus Non-Conductive Urethane,Dam,Primer - 1.5 Tubes

**C230 2 Door Coupe ..... 2006**  
 (CANADA Only)

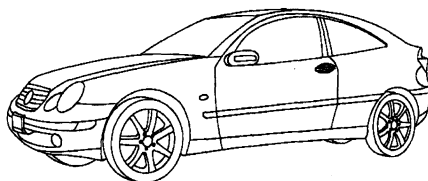

**FW02923<sup>a</sup>** Windshield (Solar) (W/Third Visor Frit, Light Sensor) ..... 32.0x55.5  
**FW02486<sup>a</sup>** Windshield (Solar) (W/Third Visor Frit, Rain/Light Sensor) ..... 32.0x55.5  
**FD21482-83** Door F/R-L (Solar) ..... 18.0x39.3

**C230 (cont.)**

**FQ21484-85<sup>c</sup>** Quarter R-L (Encap)(Solar) ..... 14.5x32.0  
**FB21487<sup>b</sup>** Back Window (Ant)(Heated)(Solar) (W/GPS, W/Alarm) ..... 29.5x47.3  
**FB21486<sup>b</sup>** Back Window (Ant)(Heated)(Solar) ..... 29.5x47.3  
<sup>a</sup> High Modulus Non-Conductive Urethane,Dam,Primer - 2 Tubes  
<sup>b</sup> High Modulus Non-Conductive Urethane,Dam,Primer - 1.5 Tubes  
<sup>c</sup> High Modulus Non-Conductive Urethane,Dam,Primer - 1 Tube

**C230 4 Door Sedan ..... 2008-2009**  
**C250 4 Door Sedan ..... 2010-2011**  
 (CANADA Only)

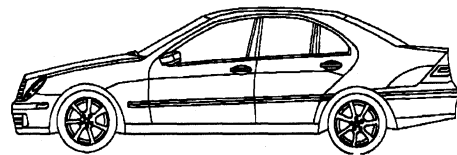

**FW02845<sup>a,b</sup>** Windshield (Encap)(Solar) (W/Third Visor Frit, Rain Sensor) (08-11) ..... 34.0x58.5  
**FD23569-70** Door F/R-L (Solar) (08-11) ..... 21.5x34.8  
**FD23571-72** Door R/R-L (Solar) (08-11) ..... 20.3x23.0  
**FV23573-74** Vent R/R-L (Encap)(Solar) (08-11) ..... 11.5x13.5  
**FB23575<sup>c</sup>** Back Window (Ant)(Heated)(Solar) (08-11) ..... 28.0x52.0  
<sup>a</sup> High Modulus Non-Conductive Urethane,Dam,Primer - 2 Tubes  
<sup>b</sup> Rain Sensor Kit  
<sup>c</sup> High Modulus Non-Conductive Urethane,Dam,Primer - 1.5 Tubes

**C230 4 Door Sedan ..... 2006-2007**  
**C280 4 Door Sedan ..... 2006-2007**  
**C350 4 Door Sedan ..... 2006-2007**  
**C55 AMG 4 Door Sedan ..... 2006**

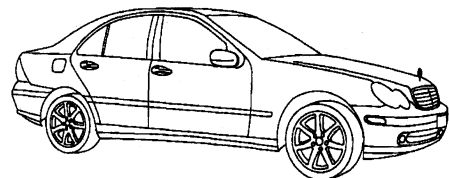

**FW02812<sup>a</sup>** Windshield (Solar) (Light Sensor) (06-07) ..... 32.2x56.3  
**FW02473<sup>a</sup>** Windshield (Solar) (Rain/Light Sensor) (06-07) ..... 32.2x56.3  
**FD24589-90** Door F/R-L (Solar) (06-07) ..... 19.1x34.7  
**FD24591-92** Door R/R-L (Solar) (06-07) ..... 21.1x21.3  
**FV20933-34** Vent R/R-L (Encap)(Solar) (06-07) ..... 12.4x13.0  
**FB20935<sup>a</sup>** Back Window (Heated)(Solar) (06-07) ..... 31.5x51.5  
<sup>a</sup> High Modulus Non-Conductive Urethane,Dam,Primer - 2 Tubes

**C300 4 Door Sedan ..... 2008-2011**  
**C350 4 Door Sedan ..... 2008-2011**  
**C63 AMG 4 Door Sedan ..... 2008-2011**

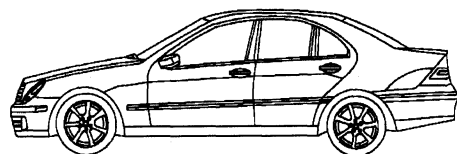

**FW02845<sup>a,b</sup>** Windshield (Encap)(Solar) (W/Third Visor Frit, Rain Sensor) ..... 34.0x58.5

**C300 (cont.)**

|   |           |
|---|-----------|
| FD23569-70 Door F/R-L (Solar)                         | 21.5x34.8 |
| FD23571-72 Door R/R-L (Solar)                         | 20.3x23.0 |
| FV23573-74 Vent R/R-L (Encap)(Solar)                  | 11.5x13.5 |
| FB23575 <sup>c</sup> Back Window (Ant)(Heated)(Solar) | 28.0x52.0 |

<sup>a</sup> High Modulus Non-Conductive Urethane,Dam,Primer - 2 Tubes  
<sup>b</sup> Rain Sensor Kit  
<sup>c</sup> High Modulus Non-Conductive Urethane,Dam,Primer - 1.5 Tubes

|                              |             |
|------------------------------|-------------|
| <b>CL500</b> 2 Door Coupe    | <b>2006</b> |
| <b>CL55 AMG</b> 2 Door Coupe | <b>2006</b> |
| <b>CL600</b> 2 Door Coupe    | <b>2006</b> |
| <b>CL65 AMG</b> 2 Door Coupe | <b>2006</b> |

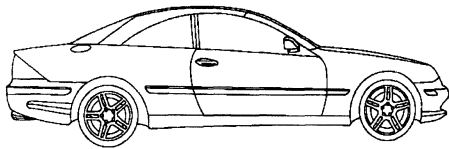

|   |           |
|---|-----------|
| FW02496 <sup>a</sup> Windshield (Solar) (Rain/Light Sensor, Solar Coated)                                 | 32.0x61.0 |
| FW02488 <sup>a</sup> Windshield (Heated)(Solar) (Rain/Light Sensor, Heated Wiper Park Area, Solar Coated) | 32.0x61.0 |
| FD20988-89 Door F/R-L (Solar) (Laminated)   | 17.0x36.0 |
| FQ20990-91 Quarter R-L (Solar) (Laminated)  | 16.0x29.0 |
| FB20992 <sup>a</sup> Back Window (Ant)(Heated)(Solar) (Laminated)   | 44.0x58.0 |

<sup>a</sup> High Modulus Non-Conductive Urethane,Dam,Primer - 2 Tubes

|                              |                  |
|------------------------------|------------------|
| <b>CL550</b> 2 Door Coupe    | <b>2007-2011</b> |
| <b>CL600</b> 2 Door Coupe    | <b>2007-2011</b> |
| <b>CL63 AMG</b> 2 Door Coupe | <b>2008-2011</b> |
| <b>CL65 AMG</b> 2 Door Coupe | <b>2008-2011</b> |

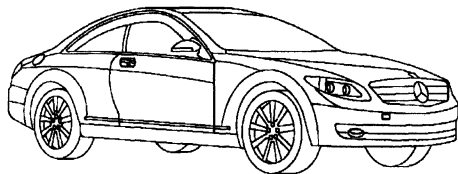

|  |           |
|--|-----------|
| FW02677 <sup>a b</sup> Windshield (Heated)(Solar) (Acoustic Interlayer, Rain/Light Sensor, Heated Wiper Park Area, Solar Coated, W/Night Vision) (07-11) | 35.0x61.0 |
| FW02676 <sup>a b</sup> Windshield (Heated)(Solar) (Acoustic Interlayer, Rain/Light Sensor, Heated Wiper Park Area, Solar Coated) (07-11)                 | 35.0x61.0 |
| FD23177-78 Door F/R-L (Solar) (Laminated, Solar Coated) (07-11)  | 17.0x38.0 |
| FQ23179-80 Quarter R-L (Solar) (Laminated, Solar Coated) (07-11)   | 17.0x39.0 |
| FB23181 <sup>a</sup> Back Window (Ant)(Encap)(Heated)(Solar) (07-11) ...   | 37.0x53.0 |

<sup>a</sup> High Modulus Non-Conductive Urethane,Dam,Primer - 2 Tubes  
<sup>b</sup> Rain Sensor Kit

|                                     |                  |
|-------------------------------------|------------------|
| <b>CLK350</b> 2 Door Convertible    | <b>2006-2011</b> |
| <b>CLK500</b> 2 Door Convertible    | <b>2006</b>      |
| <b>CLK55 AMG</b> 2 Door Convertible | <b>2006</b>      |
| <b>CLK550</b> 2 Door Convertible    | <b>2007-2011</b> |
| <b>CLK63 AMG</b> 2 Door Convertible | <b>2007-2009</b> |

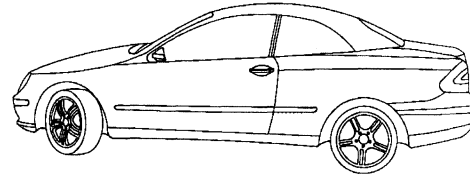

|   |           |
|---|-----------|
| FW02429 <sup>a</sup> Windshield (Solar) (Rain/Light Sensor) (06-11) | 33.0x56.0 |
| FD21843-44 Door F/R-L (Solar) (06-11)                               | 16.7x39.5 |
| FQ22140-41 Quarter R-L (Solar) (06-11)                              | 16.0x29.0 |

<sup>a</sup> High Modulus Non-Conductive Urethane,Dam,Primer - 2 Tubes

|                               |                  |
|-------------------------------|------------------|
| <b>CLK350</b> 2 Door Coupe    | <b>2006-2009</b> |
| <b>CLK500</b> 2 Door Coupe    | <b>2006</b>      |
| <b>CLK55 AMG</b> 2 Door Coupe | <b>2006</b>      |
| <b>CLK550</b> 2 Door Coupe    | <b>2007-2009</b> |
| <b>CLK63 AMG</b> 2 Door Coupe | <b>2008-2009</b> |

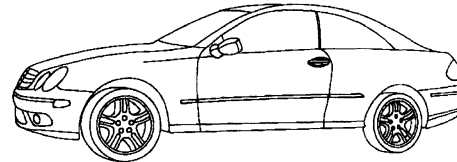

|   |           |
|---|-----------|
| FW02362 <sup>a</sup> Windshield (Solar) (Rain/Light Sensor) (06-09) | 31.0x56.0 |
| FD21843-44 Door F/R-L (Solar) (06-09)                               | 16.7x39.5 |
| FQ21845-46 Quarter R-L (Encap)(Solar) (06-09)                       | 16.3x31.5 |
| FB21847 <sup>b</sup> Back Window (Ant)(Heated)(Solar) (06-09)       | 32.5x46.5 |

<sup>a</sup> High Modulus Non-Conductive Urethane,Dam,Primer - 2 Tubes  
<sup>b</sup> High Modulus Non-Conductive Urethane,Dam,Primer - 1.5 Tubes

|                               |                  |
|-------------------------------|------------------|
| <b>CLS500</b> 4 Door Sedan    | <b>2006</b>      |
| <b>CLS55 AMG</b> 4 Door Sedan | <b>2006</b>      |
| <b>CLS550</b> 4 Door Sedan    | <b>2007-2011</b> |
| <b>CLS63 AMG</b> 4 Door Sedan | <b>2007-2011</b> |

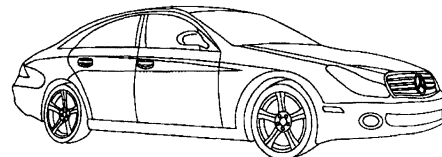

|  |           |
|--|-----------|
| FW02800 <sup>a c</sup> Windshield (Solar) (Aftermarket, Rain/Light Sensor, Solar Coated) (06-11) | 36.3x59.7 |
| FW02799 <sup>a c</sup> Windshield (Solar) (Aftermarket, Rain/Light Sensor) (06-11)               | 36.3x59.7 |
| FW02547 <sup>b c</sup> Windshield (Solar) (PAAS System, Rain/Light Sensor, Solar Coated) (06-11) | 36.3x59.7 |
| FW02546 <sup>b c</sup> Windshield (Solar) (PAAS System, Rain/Light Sensor) (06-11)               | 36.3x59.7 |
| FD22594-95 Door F/R-L (1 Holes)(Solar) (06-11)   | 19.5x29.3 |
| FD22596-97 Door R/R-L (1 Holes)(Solar) (06-11)   | 19.4x24.0 |
| FV22598-99 Vent R/R-L (Solar) (06-11)  | 9.0x12.0  |



|  |           |
|--|-----------|
| <b>CLS500</b>  | (cont.)   |
| <b>FB22824<sup>c</sup></b> Back Window (Ant)(Heated)(Solar) (Solar Coated, W/ GPS Antenna) (06-11) ..... | 31.0x51.0 |
| <b>FB22600<sup>c</sup></b> Back Window (Ant)(Heated)(Solar) (PAAS System, W/GPS Antenna) (06-11) .....   | 31.0x51.0 |
| <sup>a</sup> Not On Production Vehicles  |           |
| <sup>b</sup> On Production Vehicles  |           |
| <sup>c</sup> High Modulus Non-Conductive Urethane,Dam,Primer - 2 Tubes                                   |           |
| <b>E280</b> 4 Door Sedan.....  | 2007-2008 |
| <b>E300</b> 4 Door Sedan.....  | 2008-2009 |
| <b>E320</b> 4 Door Sedan.....  | 2006-2009 |
| <b>E350</b> 4 Door Sedan.....  | 2006-2009 |
| <b>E500</b> 4 Door Sedan.....  | 2006      |
| <b>E55 AMG</b> 4 Door Sedan.....   | 2006      |
| <b>E550</b> 4 Door Sedan.....  | 2007-2009 |
| <b>E63 AMG</b> 4 Door Sedan.....   | 2007-2009 |

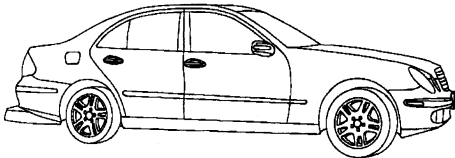

|   |           |
|---|-----------|
| <b>FW02343<sup>a</sup></b> Windshield (Solar) (W/Panoramic Glass Roof, Rain/Light Sensor, Solar Coated) (06-09) ..... | 35.3x58.3 |
| <b>FW02342<sup>a</sup></b> Windshield (Solar) (W/Panoramic Glass Roof, Rain/Light Sensor) (06-09) .....               | 35.3x58.3 |
| <b>FW02341<sup>a</sup></b> Windshield (Solar) (Rain/Light Sensor, Solar Coated) (06-09) .....                         | 35.3x58.3 |
| <b>FW02340<sup>a</sup></b> Windshield (Solar) (Rain/Light Sensor) (06-09) .....                                       | 35.3x58.3 |
| <b>FD21776-77</b> Door F/R-L (Solar) (Laminated, Solar Coated) (06-09) .....  | 21.0x35.0 |
| <b>FD21774-75</b> Door F/R-L (Solar) (06-09) .....  | 21.0x35.0 |
| <b>FD21780-81</b> Door R/R-L (Solar) (Laminated, Solar Coated) (06-09) .....  | 19.3x23.3 |
| <b>FD21778-79</b> Door R/R-L (Solar) (06-09) .....  | 19.3x23.3 |
| <b>FV21784-85</b> Vent R/R-L (Encap)(Solar) (Laminated, Solar Coated) (06-09) .....                                   | 13.0x14.0 |
| <b>FV21782-83</b> Vent R/R-L (Encap)(Solar) (06-09) .....   | 13.0x14.0 |
| <b>FB21787<sup>a</sup></b> Back Window (Ant)(Encap)(Heated)(Solar) (Laminated, Solar Coated) (06-09) .....            | 35.3x58.5 |
| <b>FB21786<sup>a</sup></b> Back Window (Ant)(Encap)(Heated)(Solar) (06-09) .....                                      | 35.3x58.5 |
| <sup>a</sup> High Modulus Non-Conductive Urethane,Dam,Primer - 2 Tubes  |           |

|                                     |      |
|-------------------------------------|------|
| <b>E350</b> 2 Door Convertible..... | 2011 |
| <b>E550</b> 2 Door Convertible..... | 2011 |

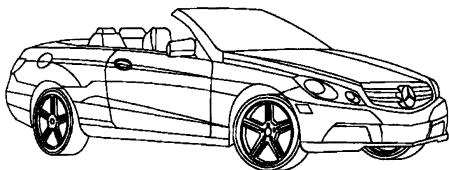

|   |           |
|---|-----------|
| <b>FW03303<sup>a</sup> b</b> Windshield (Ant)(Solar) (PAAS System, W/Third Visor Frit, Acoustic Interlayer, W/Lane Departure Warning System, Rain/Light Sensor) ..... | 31.7x55.3 |
| <b>FW03302<sup>a</sup> b</b> Windshield (Ant)(Solar) (PAAS System, W/Third Visor Frit, Acoustic Interlayer, Rain/Light Sensor) .....                                  | 31.7x55.3 |
| <b>FD24783-84</b> Door F/R-L (1 Holes)(Solar) .....   | 22.5x38.5 |
| <b>FQ24785-86</b> Quarter R-L (Solar) .....   |           |
| <b>FB24787</b> Back Window (Heated)(Solar) .....  |           |
| <sup>a</sup> High Modulus Non-Conductive Urethane,Dam,Primer - 2 Tubes  |           |
| <sup>b</sup> Rain Sensor Kit  |           |

|                               |           |
|-------------------------------|-----------|
| <b>E350</b> 2 Door Coupe..... | 2010-2011 |
| <b>E550</b> 2 Door Coupe..... | 2010-2011 |

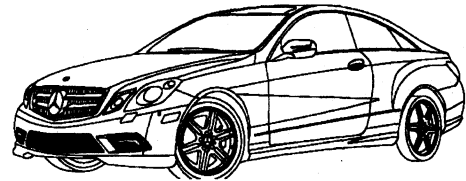

|  |           |
|--|-----------|
| <b>FW03165<sup>a</sup> b</b> Windshield (Solar) (PAAS System, W/Third Visor Frit, Acoustic Interlayer, W/Lane Departure Warning System, Rain/Light Sensor) ..... | 34.0x54.5 |
| <b>FW03164<sup>a</sup> b</b> Windshield (Solar) (PAAS System, W/Third Visor Frit, Acoustic Interlayer, Rain/Light Sensor) .....                                  | 34.0x54.5 |
| <b>FD24455-56</b> Door F/R-L (Solar) .....   | 17.0x36.0 |
| <b>FQ24457-58</b> Quarter F/R-L (Solar) (Movable) .....  | 17.0x28.5 |
| <b>FQ24459-60</b> Quarter R/R-L (Solar) (Stationary) .....   | 11.0x13.0 |
| <b>FB24462<sup>c</sup></b> Back Window (Ant)(Heated)(Solar) (PAAS System) .....  | 30.0x49.0 |
| <b>FB24461<sup>c</sup></b> Back Window (Heated)(Solar) (PAAS System) .....   | 30.0x49.0 |
| <sup>a</sup> High Modulus Non-Conductive Urethane,Dam,Primer - 2 Tubes   |           |
| <sup>b</sup> Rain Sensor Kit   |           |
| <sup>c</sup> High Modulus Urethane,Dam,Primer - 1.5 Tubes  |           |

|                                  |           |
|----------------------------------|-----------|
| <b>E350</b> 4 Door Sedan .....   | 2010-2011 |
| <b>E550</b> 4 Door Sedan .....   | 2010-2011 |
| <b>E63 AMG</b> 4 Door Sedan..... | 2010-2011 |

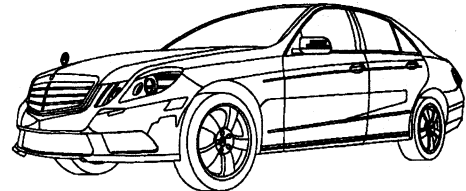

|  |           |
|--|-----------|
| <b>FW03315<sup>a</sup> b</b> Windshield (Ant)(Heated)(Solar) (PAAS System, W/ Lane Departure Warning System, Rain/Light Sensor, Heated Wiper Park Area, Solar Coated, Condensation Sensor) (From 01/01/2010) ..... | 36.0x60.0 |
| <b>FW03314<sup>a</sup> b</b> Windshield (Heated)(Solar) (PAAS System, W/Lane Departure Warning System, Rain/Light Sensor, Heated Wiper Park Area, Condensation Sensor) (From 01/01/2010) .....                     | 36.0x60.0 |
| <b>FW03313<sup>a</sup> b</b> Windshield (Ant)(Heated)(Solar) (PAAS System, W/ Lane Departure Warning System, Rain/Light Sensor, Heated Wiper Park Area, Condensation Sensor) (From 01/01/2010) .....               | 36.0x60.0 |
| <b>FW03312<sup>a</sup> b</b> Windshield (Heated)(Solar) (PAAS System, Rain/Light Sensor, Heated Wiper Park Area) (From 01/01/2010) ..  | 36.0x60.0 |
| <b>FW03168<sup>a</sup> b</b> Windshield (Ant)(Heated)(Solar) (PAAS System, W/ Lane Departure Warning System, Rain/Light Sensor, Heated Wiper Park Area, Solar Coated) (To 12/31/2009) (10) .....                   | 36.0x60.0 |
| <b>FW03167<sup>a</sup> b</b> Windshield (Heated)(Solar) (PAAS System, Rain/Light Sensor, Heated Wiper Park Area) (To 12/31/2009) (10) .....  | 36.0x60.0 |
| <b>FW03166<sup>a</sup> b</b> Windshield (Heated)(Solar) (PAAS System, W/Lane Departure Warning System, Rain/Light Sensor, Heated Wiper Park Area) (To 12/31/2009) (10) .....                                       | 36.0x60.0 |
| <b>FD24463-64</b> Door F/R-L (Solar) .....   | 18.0x30.0 |
| <b>FD24465-66</b> Door R/R-L (Solar) .....   | 17.0x25.0 |
| <b>FV24467-68</b> Vent R/R-L (Solar) .....   | 12.0x14.0 |
| <b>FB24469<sup>c</sup></b> Back Window (Ant)(Heated)(Solar) (PAAS System) ..   | 28.0x53.0 |
| <sup>a</sup> High Modulus Non-Conductive Urethane,Dam,Primer - 2 Tubes   |           |
| <sup>b</sup> Rain Sensor Kit   |           |
| <sup>c</sup> High Modulus Non-Conductive Urethane,Dam,Primer - 1.5 Tubes   |           |

**E350 4 Door Station Wagon ..... 2011**

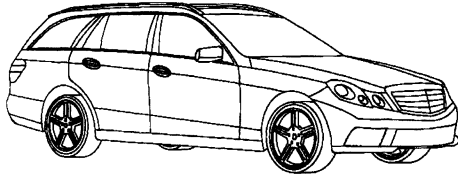

**FW03315<sup>a b</sup>** Windshield (Ant)(Heated)(Solar) (PAAS System, W/ Lane Departure Warning System, Rain/Light Sensor, Heated Wiper Park Area, Solar Coated, Condensation Sensor) ..... **36.0x60.0**

**FW03314<sup>a b</sup>** Windshield (Heated)(Solar) (PAAS System, W/Lane Departure Warning System, Rain/Light Sensor, Heated Wiper Park Area, Condensation Sensor) ..... **36.0x60.0**

**FW03313<sup>a b</sup>** Windshield (Ant)(Heated)(Solar) (PAAS System, W/ Lane Departure Warning System, Rain/Light Sensor, Heated Wiper Park Area, Condensation Sensor) ..... **36.0x60.0**

**FW03312<sup>a b</sup>** Windshield (Heated)(Solar) (PAAS System, Rain/Light Sensor, Heated Wiper Park Area) ..... **36.0x60.0**

**FD24463-64** Door F/R-L (Solar) ..... **18.0x30.0**

**FD24811-12** Door R/R-L (Solar) ..... **18.0x30.0**

**FQ24815-16<sup>c</sup>** Quarter R-L (Ant)(Encap)(Solar) ..... **36.0x60.0**

**FV24813-14<sup>c</sup>** Vent R/R-L (Solar) ..... **18.0x30.0**

**FB24817<sup>c</sup>** Back Window (Ant)(Heated)(Solar) ..... **18.0x30.0**

<sup>a</sup> High Modulus Non-Conductive Urethane,Dam,Primer - 2 Tubes  
<sup>b</sup> Rain Sensor Kit  
<sup>c</sup> High Modulus Non-Conductive Urethane,Dam,Primer - 1.5 Tubes

**E350 4 Door Station Wagon ..... 2006-2009**

**E500 4 Door Station Wagon ..... 2006**

**E55 AMG 4 Door Station Wagon..... 2006**

**E63 AMG 4 Door Station Wagon..... 2007-2009**

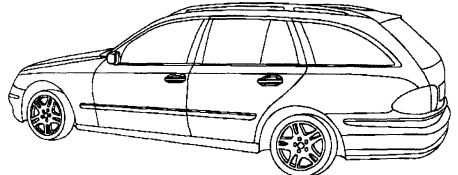

**FW02343<sup>a</sup>** Windshield (Solar) (W/Panoramic Glass Roof, Rain/Light Sensor, Solar Coated) (06-09) ..... **35.3x58.3**

**FW02342<sup>a</sup>** Windshield (Solar) (W/Panoramic Glass Roof, Rain/Light Sensor) (06-09) ..... **35.3x58.3**

**FW02341<sup>a</sup>** Windshield (Solar) (Rain/Light Sensor, Solar Coated) (06-09) ..... **35.3x58.3**

**FW02340<sup>a</sup>** Windshield (Solar) (Rain/Light Sensor) (06-09) ..... **35.3x58.3**

**FD21776-77** Door F/R-L (Solar) (Laminated, Solar Coated) (06-09) ..... **21.0x35.0**

**FD21774-75** Door F/R-L (Solar) (06-09) ..... **21.0x35.0**

**FD05562-63** Door F/R-L (06) ..... **22.2x33.7**

**FD22068-69** Door R/R-L (Solar) (Laminated, Solar Coated) (06-09) ..... **21.3x23.8**

**FD22066-67** Door R/R-L (Solar) (06-09) ..... **21.3x23.8**

**FD05582-83** Door R/R-L (06) ..... **22.2x22.7**

**FQ22076-77<sup>c</sup>** Quarter R-L (Ant)(Solar) (Laminated, Solar Coated) (06-09) ..... **14.5x34.0**

**FQ22074-75<sup>c</sup>** Quarter R-L (Ant)(Solar) (06-09) ..... **14.5x34.0**

**FQ05586-87<sup>b</sup>** Quarter R-L (06) ..... **16.5x39.0**

**FV22072-73** Vent R/R-L (Solar) (Laminated, Solar Coated) (06-09) ..... **13.2x15.5**

**FV22070-71** Vent R/R-L (Solar) (06-09) ..... **13.2x15.5**

**FV05584-85** Vent R/R-L (06) ..... **15.0x17.0**

**FB22079<sup>b</sup>** Back Window (Encap)(Heated)(1 Holes)(Solar) (Laminated, Solar Coated) (06-09) ..... **20.3x54.8**

**FB22078<sup>b</sup>** Back Window (Encap)(Heated)(1 Holes)(Solar) (06-09) ..... **20.3x54.8**

<sup>a</sup> High Modulus Non-Conductive Urethane,Dam,Primer - 2 Tubes  
<sup>b</sup> High Modulus Non-Conductive Urethane,Dam,Primer - 1.5 Tubes

**E350 (cont.)**

<sup>c</sup> High Modulus Non-Conductive Urethane,Dam,Primer - 1 Tube

**G500 4 Door Utility ..... 2006-2008**

**G55 AMG 4 Door Utility ..... 2006-2011**

**G550 4 Door Utility ..... 2009-2011**

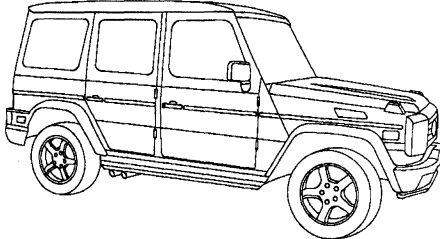

**FW02469<sup>a</sup>** Windshield (Ant)(Heated) (Rain Sensor, Fine Wire Heated, Light Sensor) (06-11) ..... **20.5x57.6**

**FW02311<sup>a</sup>** Windshield (Ant) (Rain Sensor, Light Sensor) (06-11) ..... **20.5x57.6**

**FD21696** Door F/R-L (06-11) ..... **21.0x30.0**

**FD21697** Door R/R-L (06-11) ..... **21.0x27.0**

**FQ21699<sup>b</sup>** Quarter L (Ant) (06-11) ..... **19.0x30.0**

**FQ21698<sup>b</sup>** Quarter R (06-11) ..... **19.0x30.0**

**FB21700<sup>a</sup>** Back Window (Heated) (06-11) ..... **19.5x35.3**

<sup>a</sup> High Modulus Non-Conductive Urethane,Dam,Primer - 1.5 Tubes  
<sup>b</sup> High Modulus Non-Conductive Urethane,Dam,Primer - 1 Tube

**GL320 CDI 4 Door Utility ..... 2007-2009**

**GL350 4 Door Utility ..... 2010-2011**

**GL450 4 Door Utility ..... 2007-2011**

**GL550 4 Door Utility ..... 2008-2011**

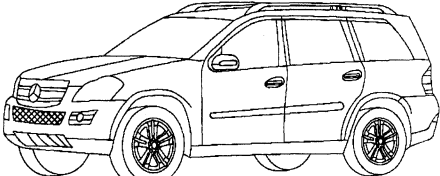

**FW02826<sup>a</sup>** Windshield (Encap)(Solar) (W/Third Visor Frit, Acoustic Interlayer, Rain Sensor) (08-11) ..... **36.0x60.0**

**FW02825<sup>a</sup>** Windshield (Encap)(Solar) (W/Third Visor Frit, Laser Deletion Area, W/Compass, Solar Coated, Rain Sensor) (08-11) ..... **36.0x60.0**

**FW02824<sup>a</sup>** Windshield (Encap)(Solar) (W/Third Visor Frit, Rain Sensor) (08-11) ..... **36.0x60.0**

**FW02692<sup>a</sup>** Windshield (Encap)(Solar) (Acoustic Interlayer, Rain Sensor) (07) ..... **36.0x60.0**

**FW02559<sup>a</sup>** Windshield (Encap)(Solar) (Laser Deletion Area, W/ Compass, Solar Coated, Rain Sensor) (07) ..... **36.0x60.0**

**FW02558<sup>a</sup>** Windshield (Encap)(Solar) (Rain Sensor) (07) ..... **36.0x60.0**

**FD22822-23** Door F/R-L (Solar) (Laminated) (07-11) ..... **23.0x36.0**

**FD22630-31** Door F/R-L (Solar) (07-11) ..... **23.0x36.0**

**FD23046-47** Door R/R-L (Solar) (07-11) ..... **24.5x26.8**

**FQ23106-07<sup>c</sup>** Quarter R-L (Ant)(Encap)(Solar) (07-11) ..... **16.0x29.5**

**FQ23050-51<sup>c</sup>** Quarter R-L (Encap)(Solar) (07-11) ..... **16.0x29.5**

**FV23048-49** Vent R/R-L (Solar) (07-11) ..... **9.0x17.0**

**FB23108<sup>b</sup>** Back Window (Ant)(Heated)(1 Holes)(Solar) (W/ Wiper, W/TV Antenna) (07-11) ..... **16.5x60.5**

**FB23052<sup>b</sup>** Back Window (Heated)(1 Holes)(Solar) (W/Wiper) (07-11) ..... **16.5x60.5**

<sup>a</sup> High Modulus Non-Conductive Urethane,Dam,Primer - 2 Tubes

**GL320 CDI (cont.)**

<sup>b</sup> High Modulus Non-Conductive Urethane,Dam,Primer - 1.5 Tubes  
<sup>c</sup> High Modulus Non-Conductive Urethane,Dam,Primer - 1 Tube

**GLK350 4 Door Utility ..... 2010-2011**

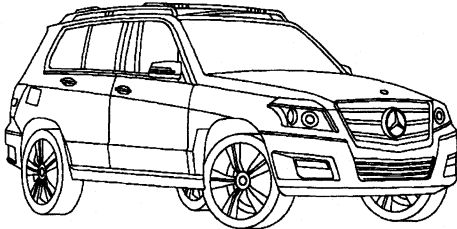

|  |           |
|--|-----------|
| FW03086 <sup>a,b</sup> Windshield (Solar) (Rain/Light Sensor) .....        | 30.0x56.0 |
| FD24223-24 Door F/R-L (Solar) .....  | 21.0x34.0 |
| FD24225-26 Door R/R-L (Solar) .....  | 20.0x20.0 |
| FQ24231-32 <sup>d</sup> Quarter R-L (Encap)(Solar) (Chrome Moulding) ..... | 16.0x17.0 |
| FQ24229-30 <sup>d</sup> Quarter R-L (Encap)(Solar) (Black Moulding) .....  | 16.0x17.0 |
| FV24227-28 <sup>d</sup> Vent R/R-L (Solar) .....                           | 9.0x16.0  |
| FB24233 <sup>c</sup> Back Window (Ant)(Heated)(1 Holes)(Solar) .....       | 18.0x57.0 |

<sup>a</sup> High Modulus Non-Conductive Urethane,Dam,Primer - 2 Tubes  
<sup>b</sup> Rain Sensor Kit  
<sup>c</sup> High Modulus Non-Conductive Urethane,Dam,Primer - 1.5 Tubes  
<sup>d</sup> High Modulus Non-Conductive Urethane,Dam,Primer - 1 Tube

|  |
|--|
| <b>ML320 CDI 4 Door Utility..... 2007-2009</b> |
| <b>ML350 4 Door Utility ..... 2006-2011</b>    |
| <b>ML450 4 Door Utility ..... 2010-2011</b>    |
| <b>ML500 4 Door Utility ..... 2006-2007</b>    |
| <b>ML550 4 Door Utility ..... 2008-2011</b>    |
| <b>ML63 AMG 4 Door Utility ..... 2007-2011</b> |

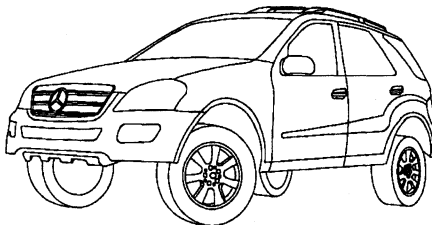

|  |           |
|--|-----------|
| FW02826 <sup>a</sup> Windshield (Encap)(Solar) (W/Third Visor Frit, Acoustic Interlayer, Rain Sensor) (08-11) .....                          | 36.0x60.0 |
| FW02825 <sup>a</sup> Windshield (Encap)(Solar) (W/Third Visor Frit, Laser Deletion Area, W/Compass, Solar Coated, Rain Sensor) (08-11) ..... | 36.0x60.0 |
| FW02824 <sup>a</sup> Windshield (Encap)(Solar) (W/Third Visor Frit, Rain Sensor) (08-11) .....   | 36.0x60.0 |
| FW02692 <sup>a</sup> Windshield (Encap)(Solar) (Acoustic Interlayer, Rain Sensor) (07) .....   | 36.0x60.0 |
| FW02559 <sup>a</sup> Windshield (Encap)(Solar) (Laser Deletion Area, W/ Compass, Solar Coated, Rain Sensor) (06-07) .....                    | 36.0x60.0 |
| FW02558 <sup>a</sup> Windshield (Encap)(Solar) (Rain Sensor) (06-07) .....   | 36.0x60.0 |
| FD22822-23 Door F/R-L (Solar) (Laminated) (06-11) .....  | 23.0x36.0 |
| FD22630-31 Door F/R-L (Solar) (06-11) .....  | 23.0x36.0 |
| FD22632-33 Door R/R-L (Solar) (06-11) .....  | 23.8x24.0 |
| FQ23103-04 <sup>c</sup> Quarter R-L (Ant)(Encap)(Solar) (06-11) .....  | 17.3x33.5 |
| FQ22636-37 <sup>c</sup> Quarter R-L (Encap)(Solar) (06-11) .....   | 17.3x33.5 |
| FV22634-35 Vent R/R-L (Solar) (06-11) .....  | 13.5x15.5 |
| FB23105 <sup>b</sup> Back Window (Ant)(Heated)(Solar) (W/TV Antenna) (06-11) .....   | 18.0x58.0 |
| FB22638 <sup>b</sup> Back Window (Ant)(Heated)(Solar) (06-11) .....  | 18.0x58.0 |

**ML320 CDI (cont.)**

<sup>a</sup> High Modulus Non-Conductive Urethane,Dam,Primer - 2 Tubes  
<sup>b</sup> High Modulus Non-Conductive Urethane,Dam,Primer - 1.5 Tubes  
<sup>c</sup> High Modulus Non-Conductive Urethane,Dam,Primer - 1 Tube

|  |
|--|
| <b>R320 CDI 4 Door Station Wagon ..... 2007-2009</b> |
| <b>R350 4 Door Station Wagon ..... 2006-2010</b>     |
| <b>R500 4 Door Station Wagon ..... 2006-2007</b>     |
| <b>R550 4 Door Station Wagon ..... 2008</b>          |
| <b>R63 AMG 4 Door Station Wagon..... 2007</b>        |

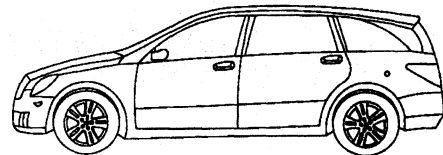

|  |           |
|--|-----------|
| FW02601 <sup>a</sup> Windshield (Solar) (Laser Deletion Area, Solar Coated, Rain Sensor) (06-10) ..... | 45.3x60.5 |
| FW02600 <sup>a</sup> Windshield (Solar) (Rain Sensor) (06-10) .....                                    | 45.3x60.5 |
| FD22759-60 Door F/R-L (Solar) (Laminated) (06-10) .....  | 23.0x41.0 |
| FD22757-58 Door F/R-L (Solar) (06-10) .....  | 23.0x41.0 |
| FD22763-64 Door R/R-L (Solar) (06-10) .....  | 24.0x31.0 |
| FD22761-62 Door R/R-L (Solar) (Export Only) (06-10) .....  | 23.5x25.0 |
| FQ22775-76 <sup>c</sup> Quarter R-L (Ant)(Encap)(Solar) (06-10) .....                                  | 15.5x37.0 |
| FQ22773-74 <sup>c</sup> Quarter R-L (Encap)(Solar) (06-10) .....                                       | 15.5x37.0 |
| FQ22771-72 <sup>c</sup> Quarter R-L (Ant)(Encap)(Solar) (Export Only) (06-10) .....                    | 16.3x30.5 |
| FQ22769-70 <sup>c</sup> Quarter R-L (Encap)(Solar) (Export Only) (06-10) .....                         | 16.3x30.5 |
| FV22767-68 Vent R/R-L (Encap)(Solar) (06-10) .....   | 11.5x17.5 |
| FV22765-66 Vent R/R-L (Encap)(Solar) (Export Only) (06-10) .....                                       | 10.5x17.5 |
| FB22777 <sup>b</sup> Back Window (Ant)(Heated)(Solar) (06-10) .....                                    | 17.0x63.5 |

<sup>a</sup> High Modulus Non-Conductive Urethane,Dam,Primer - 2 Tubes  
<sup>b</sup> High Modulus Non-Conductive Urethane,Dam,Primer - 1.5 Tubes  
<sup>c</sup> High Modulus Non-Conductive Urethane,Dam,Primer - 1 Tube

|  |
|--|
| <b>S350 4 Door Sedan ..... 2006</b>    |
| <b>S500 4 Door Sedan ..... 2006</b>    |
| <b>S55 AMG 4 Door Sedan ..... 2006</b> |
| <b>S600 4 Door Sedan ..... 2006</b>    |
| <b>S65 AMG 4 Door Sedan ..... 2006</b> |

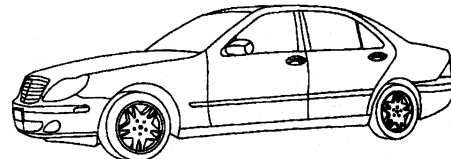

|  |           |
|--|-----------|
| FW02720 <sup>a</sup> Windshield (Heated)(Solar) (Rain/Light Sensor, Heated Wiper Park Area, Solar Coated) .....                      | 38.1x60.0 |
| FW02347 <sup>a</sup> Windshield (Heated)(Solar) (Laser Deletion Area, Rain/Light Sensor, Heated Wiper Park Area, Solar Coated) ..... | 38.1x60.0 |
| FW02346 <sup>a</sup> Windshield (Heated)(Solar) (Rain/Light Sensor, Heated Wiper Park Area) .....                                    | 38.1x60.0 |
| FD21767-68 Door F/R-L (Solar) (Laminated, Solar Coated) .....  | 19.0x30.5 |
| FD20767-68 Door F/R-L (Solar) (Laminated) .....  | 19.0x30.5 |
| FD21769-70 Door R/R-L (Solar) (Laminated, 121.5" WB, Solar Coated) .....   | 19.0x28.5 |
| FD20769-70 Door R/R-L (Solar) (Laminated, 121.5" WB) .....   | 19.0x28.5 |
| FV21771-72 Vent R/R-L (Solar) (Laminated, Solar Coated) .....  | 11.0x12.0 |
| FV20771-72 Vent R/R-L (Solar) (Laminated) .....  | 11.0x12.0 |
| FB21773 <sup>a</sup> Back Window (Ant)(Heated)(Solar) (Laminated, Solar Coated) .....  | 32.5x53.5 |

**S350 (cont.)**

|   |                  |
|---|------------------|
| <b>FB20773<sup>a</sup></b> Back Window (Ant)(Heated)(Solar) (Laminated) ..... | <b>32.3x53.5</b> |
| <sup>a</sup> High Modulus Non-Conductive Urethane,Dam,Primer - 2 Tubes        |                  |

|                                  |                  |
|----------------------------------|------------------|
| <b>S400</b> 4 Door Sedan .....   | <b>2010-2011</b> |
| <b>S550</b> 4 Door Sedan .....   | <b>2007-2011</b> |
| <b>S600</b> 4 Door Sedan .....   | <b>2007-2011</b> |
| <b>S63 AMG</b> 4 Door Sedan..... | <b>2008-2011</b> |
| <b>S65 AMG</b> 4 Door Sedan..... | <b>2007-2011</b> |

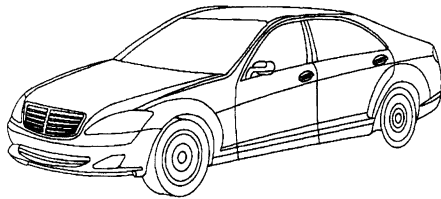

|   |                  |
|---|------------------|
| <b>FW02609<sup>a</sup></b> Windshield (Encap)(Heated)(Solar) (W/Third Visor Frit, Laser Deletion Area, Rain/Light Sensor, Heated Wiper Park Area, Solar Coated, W/Night Vision) (07-11) ..... | <b>32.9x53.6</b> |
| <b>FW02608<sup>a</sup></b> Windshield (Encap)(Heated)(Solar) (W/Third Visor Frit, Laser Deletion Area, Rain/Light Sensor, Heated Wiper Park Area, Solar Coated) (07-11) .....                 | <b>32.9x53.6</b> |
| <b>FW02607<sup>a</sup></b> Windshield (Encap)(Heated)(Solar) (W/Third Visor Frit, Rain/Light Sensor, Heated Wiper Park Area) (07-11) .....  | <b>32.9x53.6</b> |
| <b>FW02606<sup>a</sup></b> Windshield (Encap)(Solar) (W/Third Visor Frit) (07-11) .....   | <b>32.9x53.6</b> |
| <b>FD22839-40</b> Door F/R-L (Solar) (Laminated, Acoustic Interlayer, Solar Coated) (07-11) .....   | <b>22.8x37.0</b> |
| <b>FD22837-38</b> Door F/R-L (Solar) (07-11) .....  | <b>22.8x37.0</b> |
| <b>FD22847-48</b> Door R/R-L (Solar) (Laminated, Acoustic Interlayer, Solar Coated, LWB) (07-11) .....  | <b>21.0x29.5</b> |
| <b>FD22845-46</b> Door R/R-L (Solar) (LWB) (07-11) .....  | <b>21.0x29.5</b> |
| <b>FV22851-52</b> Vent R/R-L (Encap)(Solar) (Laminated, Acoustic Interlayer, Solar Coated) (07-11) .....  | <b>12.3x14.8</b> |
| <b>FV22849-50</b> Vent R/R-L (Encap)(Solar) (07-11) .....   | <b>12.3x14.8</b> |
| <b>FB22854<sup>a</sup></b> Back Window (Ant)(Encap)(Heated)(Solar) (Laminated, Solar Coated) (07-11) .....  | <b>33.0x53.8</b> |
| <b>FB22853<sup>a</sup></b> Back Window (Ant)(Encap)(Heated)(Solar) (07-11) .....  | <b>33.0x53.8</b> |
| <sup>a</sup> High Modulus Non-Conductive Urethane,Dam,Primer - 2 Tubes  |                  |

**S430** 4 Door Sedan ..... **2006**

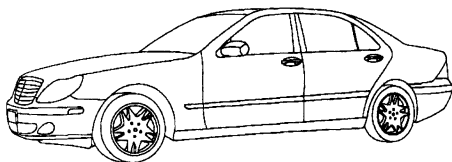

|  |                  |
|--|------------------|
| <b>FW02720<sup>a</sup></b> Windshield (Heated)(Solar) (Rain/Light Sensor, Heated Wiper Park Area, Solar Coated) .....                      | <b>38.1x60.0</b> |
| <b>FW02347<sup>a</sup></b> Windshield (Heated)(Solar) (Laser Deletion Area, Rain/Light Sensor, Heated Wiper Park Area, Solar Coated) ..... | <b>38.1x60.0</b> |
| <b>FW02346<sup>a</sup></b> Windshield (Heated)(Solar) (Rain/Light Sensor, Heated Wiper Park Area) .....                                    | <b>38.1x60.0</b> |
| <b>FD21767-68</b> Door F/R-L (Solar) (Laminated, Solar Coated) .....   | <b>19.0x30.5</b> |
| <b>FD20767-68</b> Door F/R-L (Solar) (Laminated) .....   | <b>19.0x30.5</b> |
| <b>FD21769-70</b> Door R/R-L (Solar) (Laminated, 121.5" WB, Solar Coated) .....  | <b>19.0x28.5</b> |
| <b>FD21382-83</b> Door R/R-L (Solar) (Laminated, 116.7" WB, Canada Only) .....   | <b>19.0x24.3</b> |
| <b>FD20769-70</b> Door R/R-L (Solar) (Laminated, 121.5" WB) .....  | <b>19.0x28.5</b> |

**S430 (cont.)**

|   |                  |
|---|------------------|
| <b>FV21771-72</b> Vent R/R-L (Solar) (Laminated, Solar Coated) .....                        | <b>11.0x12.0</b> |
| <b>FV20771-72</b> Vent R/R-L (Solar) (Laminated) .....                                      | <b>11.0x12.0</b> |
| <b>FB21773<sup>a</sup></b> Back Window (Ant)(Heated)(Solar) (Laminated, Solar Coated) ..... | <b>32.5x53.5</b> |
| <b>FB20773<sup>a</sup></b> Back Window (Ant)(Heated)(Solar) (Laminated) .....               | <b>32.3x53.5</b> |
| <sup>a</sup> High Modulus Non-Conductive Urethane,Dam,Primer - 2 Tubes                      |                  |

**S450** 4 Door Sedan ..... **2008-2011**  
(CANADA Only)

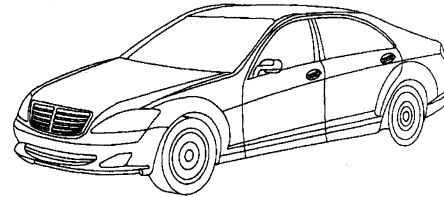

|   |                  |
|---|------------------|
| <b>FW02609<sup>a</sup></b> Windshield (Encap)(Heated)(Solar) (W/Third Visor Frit, Laser Deletion Area, Rain/Light Sensor, Heated Wiper Park Area, Solar Coated, W/Night Vision) ..... | <b>32.9x53.6</b> |
| <b>FW02608<sup>a</sup></b> Windshield (Encap)(Heated)(Solar) (W/Third Visor Frit, Laser Deletion Area, Rain/Light Sensor, Heated Wiper Park Area, Solar Coated) .....                 | <b>32.9x53.6</b> |
| <b>FW02607<sup>a</sup></b> Windshield (Encap)(Heated)(Solar) (W/Third Visor Frit, Rain/Light Sensor, Heated Wiper Park Area) .....  | <b>32.9x53.6</b> |
| <b>FW02606<sup>a</sup></b> Windshield (Encap)(Solar) (W/Third Visor Frit) .....   | <b>32.9x53.6</b> |
| <b>FD22839-40</b> Door F/R-L (Solar) (Laminated, Acoustic Interlayer, Solar Coated) .....   | <b>22.8x37.0</b> |
| <b>FD22837-38</b> Door F/R-L (Solar) .....  | <b>22.8x37.0</b> |
| <b>FD22843-44</b> Door R/R-L (Solar) (Laminated, Acoustic Interlayer, Solar Coated) .....   | <b>21.1x24.4</b> |
| <b>FD22841-42</b> Door R/R-L (Solar) .....  | <b>21.1x24.4</b> |
| <b>FV22851-52</b> Vent R/R-L (Encap)(Solar) (Laminated, Acoustic Interlayer, Solar Coated) .....  | <b>12.3x14.8</b> |
| <b>FV22849-50</b> Vent R/R-L (Encap)(Solar) .....   | <b>12.3x14.8</b> |
| <b>FB22854<sup>a</sup></b> Back Window (Ant)(Encap)(Heated)(Solar) (Laminated, Solar Coated) .....  | <b>33.0x53.8</b> |
| <b>FB22853<sup>a</sup></b> Back Window (Ant)(Encap)(Heated)(Solar) .....  | <b>33.0x53.8</b> |
| <sup>a</sup> High Modulus Non-Conductive Urethane,Dam,Primer - 2 Tubes  |                  |

|  |                  |
|--|------------------|
| <b>SL500</b> 2 Door Convertible .....    | <b>2006</b>      |
| <b>SL55 AMG</b> 2 Door Convertible ..... | <b>2006-2008</b> |
| <b>SL550</b> 2 Door Convertible .....    | <b>2007-2011</b> |
| <b>SL600</b> 2 Door Convertible .....    | <b>2006-2011</b> |
| <b>SL63 AMG</b> 2 Door Convertible ..... | <b>2009-2011</b> |
| <b>SL65 AMG</b> 2 Door Convertible ..... | <b>2006-2011</b> |

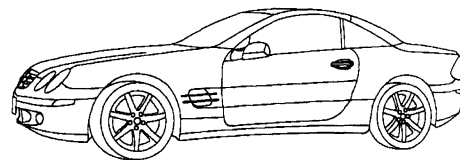

|  |                  |
|--|------------------|
| <b>FW02668<sup>a</sup></b> Windshield (Ant)(Heated)(Solar) (Rain/Light Sensor, Heated Wiper Park Area) (06-11) ..... | <b>33.0x57.0</b> |
| <b>FD21726-27</b> Door F/R-L (Solar) (06-11) .....   | <b>16.0x38.0</b> |
| <b>FQ21728-29</b> Quarter R-L (Solar) (06-11) .....  | <b>13.0x18.0</b> |
| <b>FB21730<sup>b</sup></b> Back Window (Heated)(Solar) (06-11) .....   | <b>27.8x33.8</b> |
| <sup>a</sup> High Modulus Non-Conductive Urethane,Dam,Primer - 2 Tubes   |                  |
| <sup>b</sup> High Modulus Non-Conductive Urethane,Dam,Primer - 1.5 Tubes   |                  |

|   |                  |
|---|------------------|
| <b>SLK280</b> 2 Door Convertible.....     | <b>2006-2008</b> |
| <b>SLK300</b> 2 Door Convertible.....     | <b>2009-2011</b> |
| <b>SLK350</b> 2 Door Convertible.....     | <b>2006-2011</b> |
| <b>SLK55 AMG</b> 2 Door Convertible ..... | <b>2006-2011</b> |

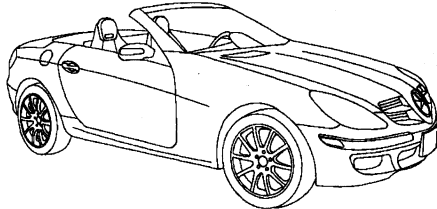

|   |                  |
|---|------------------|
| <b>FW02881<sup>b</sup></b> Windshield (Solar) (Rain Sensor) (From 12/01/2004) (06-11) ..... | <b>29.0x56.0</b> |
| <b>FW02497<sup>a b</sup></b> Windshield (Solar) (Rain Sensor) (To 12/01/2004) (06-11) ..... | <b>29.0x56.0</b> |
| <b>FD22396-97</b> Door F/R-L (06-11) .....  | <b>15.0x37.0</b> |
| <b>FQ24318-19</b> Quarter R-L (06-11) .....   | <b>24.0x37.0</b> |
| <b>FB22398<sup>c</sup></b> Back Window (06-11) .....  | <b>24.0x37.0</b> |

<sup>a</sup> May Require Replacement of Rain Sensor  
<sup>b</sup> High Modulus Non-Conductive Urethane,Dam,Primer - 2 Tubes  
<sup>c</sup> High Modulus Non-Conductive Urethane,Dam,Primer - 1.5 Tubes

**Sprinter 144" WB Van..... 2010-2011**

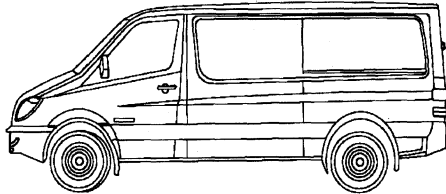

|   |                  |
|---|------------------|
| <b>DW01721<sup>a i</sup></b> Windshield (Heated)(Solar) (W/Third Visor Frit, Rain/Light Sensor, Fully Heated) ..... | <b>42.0x70.0</b> |
| <b>DW01720<sup>a i</sup></b> Windshield (Solar) (W/Third Visor Frit, Rain/Light Sensor) .....                       | <b>42.0x70.0</b> |
| <b>DW01719<sup>a i</sup></b> Windshield (Solar) (W/Third Visor Frit) .....  | <b>42.0x70.0</b> |
| <b>DD11394-95</b> Door F/R-L (Solar) .....  | <b>30.3x56.0</b> |
| <b>DD11857<sup>b d</sup></b> Door R/R (Encap)(Solar) (Sliding Cargo Door, Aftermarket, Movable) .....               | <b>30.3x56.0</b> |
| <b>DD11396-97<sup>c</sup></b> Door R/R-L (Solar) (Sliding Cargo Door) .....   | <b>30.3x56.0</b> |
| <b>DD11858<sup>b e</sup></b> Side L (Encap)(Solar) (Body Side, Aftermarket, Movable) .....                          | <b>30.3x56.0</b> |
| <b>DD11398-99<sup>c</sup></b> Side R-L (Solar) (Body Side) .....  | <b>30.3x55.3</b> |
| <b>DQ11406-07</b> Quarter F/R-L (Solar) (W/O Sliding Cargo Door, Stationary) .....                                  | <b>30.1x64.3</b> |
| <b>DQ11404-05</b> Quarter F/R-L (Solar) (Stationary, W/Sliding Cargo Door) .....                                    | <b>27.6x64.2</b> |
| <b>DQ11410-11</b> Quarter R/R-L (Solar) (W/O Sliding Cargo Door, Movable) .....                                     | <b>30.3x64.5</b> |
| <b>DQ11408-09</b> Quarter R/R-L (Solar) (Movable, W/Sliding Cargo Door) .....                                       | <b>27.8x64.3</b> |
| <b>DQ11860<sup>b g</sup></b> Quarter L (Encap)(Solar) (W/O Sliding Cargo Door, Aftermarket, Movable) .....          | <b>10.0x25.3</b> |
| <b>DQ11859<sup>b f</sup></b> Quarter R (Encap)(Solar) (Aftermarket, Movable, W/ Sliding Cargo Door) .....           | <b>31.5x33.0</b> |
| <b>DQ11402-03<sup>c</sup></b> Quarter R-L (Solar) (W/O Sliding Cargo Door, One-Piece) .....                         | <b>31.5x33.0</b> |
| <b>DQ11400-01<sup>c</sup></b> Quarter R-L (Solar) (One-Piece, W/Sliding Cargo Door) .....                           | <b>31.5x33.0</b> |
| <b>DV11392-93</b> Vent F/R-L (Solar) .....  | <b>27.8x64.3</b> |
| <b>DB11420-21<sup>j</sup></b> Back Window R-L (Heated)(Solar) .....   | <b>10.0x25.3</b> |
| <b>DB11418-19<sup>j</sup></b> Back Window R-L (Solar) .....   | <b>31.5x33.0</b> |

<sup>a</sup> May Require Two Person Installation  
<sup>b</sup> Not On Production Vehicles  
<sup>c</sup> On Production Vehicles

**Sprinter (cont.)**

- <sup>d</sup> Movable Aftermarket
- <sup>e</sup> Movable Aftermarket Replacement for DD11399
- <sup>f</sup> Movable Aftermarket Replacement for DD11400
- <sup>g</sup> Movable Aftermarket Replacement for DD11403
- <sup>h</sup> Movable Aftermarket Replacement for DD11403
- <sup>i</sup> High Modulus Non-Conductive Urethane,Dam,Primer - 2 Tubes
- <sup>j</sup> High Modulus Non-Conductive Urethane,Dam,Primer - 2.5 Tubes
- <sup>k</sup> High Modulus Non-Conductive Urethane,Dam,Primer - 1.5 Tubes

**Sprinter 170" WB Van..... 2010-2011**

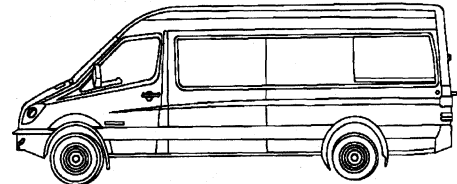

|   |                  |
|---|------------------|
| <b>DW01721<sup>a k</sup></b> Windshield (Heated)(Solar) (W/Third Visor Frit, Rain/Light Sensor, Fully Heated) ..... | <b>42.0x70.0</b> |
| <b>DW01720<sup>a k</sup></b> Windshield (Solar) (W/Third Visor Frit, Rain/Light Sensor) .....                       | <b>42.0x70.0</b> |
| <b>DW01719<sup>a k</sup></b> Windshield (Solar) (W/Third Visor Frit) .....  | <b>42.0x70.0</b> |
| <b>DD11394-95</b> Door F/R-L (Solar) .....  | <b>30.3x56.0</b> |
| <b>DD11857<sup>b d</sup></b> Door R/R (Encap)(Solar) (Sliding Cargo Door, Aftermarket, Movable) .....               | <b>30.3x56.0</b> |
| <b>DD11396-97<sup>c</sup></b> Door R/R-L (Solar) (Sliding Cargo Door) .....   | <b>30.3x56.0</b> |
| <b>DD11858<sup>b e</sup></b> Side L (Encap)(Solar) (Body Side, Aftermarket, Movable) .....                          | <b>30.3x56.0</b> |
| <b>DD11398-99<sup>c</sup></b> Side R-L (Solar) (Body Side) .....  | <b>30.3x55.3</b> |
| <b>DQ11862<sup>b g</sup></b> Quarter F/L (Encap)(Solar) (W/O Sliding Cargo Door, Aftermarket, Movable) .....        | <b>30.3x55.8</b> |
| <b>DQ11861<sup>b f</sup></b> Quarter F/R (Encap)(Solar) (Aftermarket, Movable, W/ Sliding Cargo Door) .....         | <b>30.3x55.3</b> |
| <b>DQ11414-15<sup>c</sup></b> Quarter F/R-L (Solar) (W/O Sliding Cargo Door) .....                                  | <b>30.3x56.0</b> |
| <b>DQ11412-13<sup>c</sup></b> Quarter F/R-L (Solar) (W/Sliding Cargo Door) .....                                    | <b>27.8x55.8</b> |
| <b>DQ11864<sup>b i</sup></b> Quarter R/L (Encap)(Solar) (Aftermarket, Movable) ..                                   | <b>29.6x49.0</b> |
| <b>DQ11863<sup>b h</sup></b> Quarter R/R (Encap)(Solar) (Aftermarket, Movable) ..                                   | <b>29.6x52.8</b> |
| <b>DQ11416-17<sup>c</sup></b> Quarter R/R-L (Solar) .....   | <b>30.3x49.5</b> |
| <b>DV11392-93</b> Vent F/R-L (Solar) .....  | <b>10.0x25.3</b> |
| <b>DB11420-21<sup>j</sup></b> Back Window R-L (Heated)(Solar) .....   | <b>31.5x33.0</b> |
| <b>DB11418-19<sup>j</sup></b> Back Window R-L (Solar) .....   | <b>31.5x33.0</b> |

- <sup>a</sup> May Require Two Person Installation
- <sup>b</sup> Not On Production Vehicles
- <sup>c</sup> On Production Vehicles
- <sup>d</sup> Movable Aftermarket
- <sup>e</sup> Movable Aftermarket Replacement for DD11399
- <sup>f</sup> Movable Aftermarket Replacement for DD11412
- <sup>g</sup> Movable Aftermarket Replacement for DD11415
- <sup>h</sup> Movable Aftermarket Replacement for DD11416
- <sup>i</sup> Movable Aftermarket Replacement for DD11417
- <sup>j</sup> High Modulus Non-Conductive Urethane,Dam,Primer - 2 Tubes
- <sup>k</sup> High Modulus Non-Conductive Urethane,Dam,Primer - 2.5 Tubes
- <sup>l</sup> High Modulus Non-Conductive Urethane,Dam,Primer - 1.5 Tubes

**Grand Marquis 4 Door Sedan..... 2006-2010  
(USA Only)**

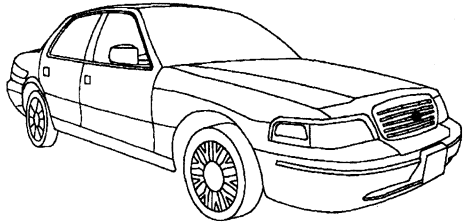

|   |                  |
|---|------------------|
| <b>DW01735<sup>a c d</sup></b> Windshield (Solar) (W/Third Visor Frit, Aftermarket, Solar Coated) ..... | <b>33.1x65.0</b> |
| <b>DW01506<sup>b c d</sup></b> Windshield (Solar) (W/Third Visor Frit) .....                            | <b>33.1x65.0</b> |
| <b>DD10225-26</b> Door F/R-L (Solar) (Laminated) .....  | <b>21.9x34.7</b> |
| <b>DD08626-27</b> Door F/R-L (2 Holes)(Solar) .....   | <b>23.0x34.8</b> |
| <b>DD10227-28</b> Door R/R-L (Solar) (Laminated) .....  | <b>20.1x21.9</b> |
| <b>DD09914-15</b> Door R/R-L (2 Holes)(Solar) (LWB) .....   | <b>23.4x26.1</b> |
| <b>DD08636-37</b> Door R/R-L (2 Holes)(Solar) .....   | <b>20.2x23.0</b> |
| <b>DR10797</b> Roof (Solar) (Assembly) .....  | <b>18.1x31.6</b> |
| <b>DV10039-40</b> Vent R/R-L (Solar) (Taxi, Assembly, Police, LWB) .....                                | <b>13.0x19.3</b> |
| <b>DV08638-39</b> Vent R/R-L (Solar) .....  | <b>13.0x19.3</b> |
| <b>DB10949<sup>c</sup></b> Back Window (Ant)(Heated)(Solar) .....                                       | <b>23.8x61.9</b> |

<sup>a</sup> Not On Production Vehicles  
<sup>b</sup> On Production Vehicles  
<sup>c</sup> Urethane,Dam,Primer - 2 Tubes  
<sup>d</sup> Fast-Cure Urethane/Dam/Primer - Quantity 2

**Mariner 4 Door Utility..... 2008-2010**

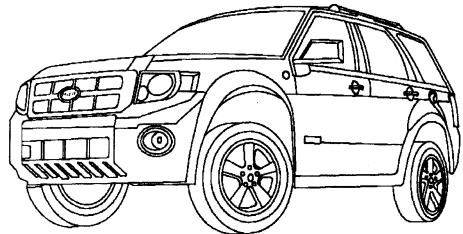

|  |                  |
|--|------------------|
| <b>DW01795<sup>a c d</sup></b> Windshield (Solar) (W/Third Visor Frit, Aftermarket) .....          | <b>33.8x55.5</b> |
| <b>DW01684<sup>b c d</sup></b> Windshield (Solar) (W/Third Visor Frit, Acoustic Inter-layer) ..... | <b>33.8x55.5</b> |
| <b>DD11259-60</b> Door F/R-L (Solar) .....   | <b>21.3x32.8</b> |
| <b>DD11261-62</b> Door R/R-L (Solar) .....   | <b>19.9x28.4</b> |
| <b>DR11711</b> Roof (Encap)(Solar) (09-10) .....   | <b>19.1x34.5</b> |
| <b>DR09758</b> Roof (Encap)(Solar) (08) .....  | <b>19.1x34.5</b> |
| <b>DQ11263-64<sup>e</sup></b> Quarter R-L (Solar) .....  | <b>16.9x29.4</b> |
| <b>DB11266</b> Back Window (Heated)(3 Holes)(Solar) .....  | <b>18.8x50.4</b> |

<sup>a</sup> Not On Production Vehicles  
<sup>b</sup> On Production Vehicles  
<sup>c</sup> Urethane,Dam,Primer - 2 Tubes  
<sup>d</sup> Fast-Cure Urethane/Dam/Primer - Quantity 2  
<sup>e</sup> Urethane,Dam,Primer - 1 Tube

**Mariner HYBRID 4 Door Utility..... 2008-2010**

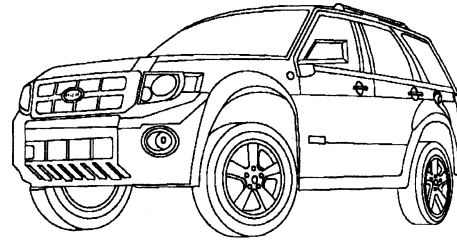

|  |                  |
|--|------------------|
| <b>DW01795<sup>a c d</sup></b> Windshield (Solar) (W/Third Visor Frit, Aftermarket) .....          | <b>33.8x55.5</b> |
| <b>DW01684<sup>b c d</sup></b> Windshield (Solar) (W/Third Visor Frit, Acoustic Inter-layer) ..... | <b>33.8x55.5</b> |
| <b>DD11259-60</b> Door F/R-L (Solar) .....   | <b>21.3x32.8</b> |
| <b>DD11261-62</b> Door R/R-L (Solar) .....   | <b>19.9x28.4</b> |
| <b>DR11711</b> Roof (Encap)(Solar) (09-10) .....   | <b>19.1x34.5</b> |
| <b>DR09758</b> Roof (Encap)(Solar) (08) .....  | <b>19.1x34.5</b> |
| <b>DQ11265<sup>e</sup></b> Quarter L (Solar) (Hybrid, W/Battery Vent) .....                        | <b>16.9x29.4</b> |
| <b>DQ11263<sup>e</sup></b> Quarter R (Solar) .....   | <b>16.9x29.4</b> |
| <b>DB11266</b> Back Window (Heated)(3 Holes)(Solar) .....  | <b>18.8x50.4</b> |

<sup>a</sup> Not On Production Vehicles  
<sup>b</sup> On Production Vehicles  
<sup>c</sup> Urethane,Dam,Primer - 2 Tubes  
<sup>d</sup> Fast-Cure Urethane/Dam/Primer - Quantity 2  
<sup>e</sup> Urethane,Dam,Primer - 1 Tube

**Mariner 4 Door Utility..... 2006-2007**

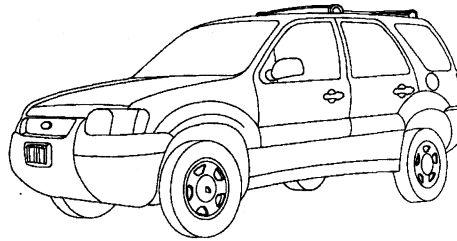

|  |                  |
|--|------------------|
| <b>DW01579<sup>a b</sup></b> Windshield (Solar) (W/Third Visor Frit) ..... | <b>33.8x55.5</b> |
| <b>DD09751-52</b> Door F/R-L (2 Holes)(Solar) .....                        | <b>21.3x33.7</b> |
| <b>DD09753-54</b> Door R/R-L (2 Holes)(Solar) .....                        | <b>21.1x28.4</b> |
| <b>DR09758</b> Roof (Encap)(Solar) .....                                   | <b>19.1x34.5</b> |
| <b>DQ10055-56<sup>c</sup></b> Quarter R-L (Solar) .....                    | <b>18.1x29.4</b> |
| <b>DB10273</b> Back Window (Heated)(8 Holes)(Solar) .....                  | <b>18.6x50.3</b> |

<sup>a</sup> Urethane,Dam,Primer - 2 Tubes  
<sup>b</sup> Fast-Cure Urethane/Dam/Primer - Quantity 2  
<sup>c</sup> Urethane,Dam,Primer - 1 Tube

**Mariner HYBRID 4 Door Utility..... 2006-2007**

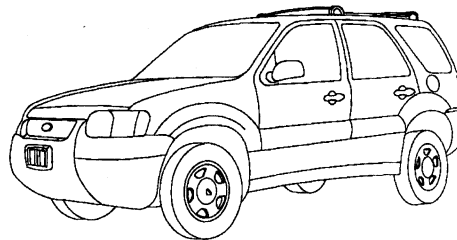

|  |                  |
|--|------------------|
| <b>DW01579<sup>a b</sup></b> Windshield (Solar) (W/Third Visor Frit) ..... | <b>33.8x55.5</b> |
| <b>DD09751-52</b> Door F/R-L (2 Holes)(Solar) .....                        | <b>21.3x33.7</b> |
| <b>DD09753-54</b> Door R/R-L (2 Holes)(Solar) .....                        | <b>21.1x28.4</b> |

**Mariner (cont.)**

|                            |   |           |
|----------------------------|---|-----------|
| <b>DR09758</b>             | Roof (Encap)(Solar)                     | 19.1x34.5 |
| <b>DQ10721<sup>c</sup></b> | Quarter L (Solar) (W/Battery Vent Duct) | 18.1x25.0 |
| <b>DQ10055<sup>c</sup></b> | Quarter R (Solar)                       | 18.1x29.4 |
| <b>DB10273</b>             | Back Window (Heated)(8 Holes)(Solar)    | 18.6x50.3 |

<sup>a</sup> Urethane,Dam,Primer - 2 Tubes  
<sup>b</sup> Fast-Cure Urethane/Dam/Primer - Quantity 2  
<sup>c</sup> Urethane,Dam,Primer - 1 Tube

**Milan 4 Door Sedan..... 2006-2010**

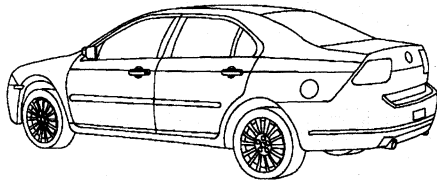

|                                  |  |           |
|----------------------------------|--|-----------|
| <b>DW01782<sup>a d e</sup></b>   | Windshield (Solar) (W/Third Visor Frit, Acoustic Inter-layer) (10) | 42.0x58.5 |
| <b>DW01622<sup>b c d e</sup></b> | Windshield (Solar) (W/Third Visor Frit)                            | 42.0x58.5 |
| <b>DD10919-20</b>                | Door F/R-L (Solar)   | 22.0x39.0 |
| <b>DD10923-24</b>                | Door R/R-L (Solar)   | 20.3x27.0 |
| <b>DR11738</b>                   | Roof (Solar) (From 11/04/2008) (09-10)                             | 18.9x32.5 |
| <b>DR10981</b>                   | Roof (Solar) (To 11/04/2008) (06-09)                               | 18.9x32.5 |
| <b>DV10925-26</b>                | Vent R/R-L (Solar)   | 9.8x11.3  |
| <b>DB11615<sup>d</sup></b>       | Back Window (Heated)(Solar) (10)                                   | 32.4x51.1 |
| <b>DB11179<sup>d</sup></b>       | Back Window (Heated)(Solar) (07-09)                                | 32.4x51.1 |
| <b>DB10927<sup>d</sup></b>       | Back Window (Ant)(Heated)(Solar) (4 Leads) (06)                    | 32.4x51.1 |

<sup>a</sup> On Production Vehicles  
<sup>b</sup> Not On Production Vehicles 2010-2011  
<sup>c</sup> On Production Vehicles 2006-2009  
<sup>d</sup> Urethane,Dam,Primer - 2 Tubes  
<sup>e</sup> Fast-Cure Urethane/Dam/Primer - Quantity 2

**Montego 4 Door Sedan..... 2006-2007**

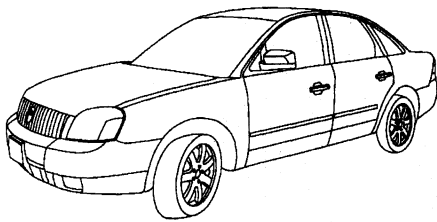

|                               |                             |           |
|-------------------------------|-----------------------------|-----------|
| <b>DW01568<sup>a b</sup></b>  | Windshield (Solar)          | 38.9x63.7 |
| <b>DD10683-84</b>             | Door F/R-L (Solar)          | 22.6x34.3 |
| <b>DD10685-86</b>             | Door R/R-L (Solar)          | 22.2x30.3 |
| <b>DR10690</b>                | Roof (Solar)                | 17.8x33.5 |
| <b>DQ10687-88<sup>c</sup></b> | Quarter R-L (Encap)(Solar)  | 14.0x24.3 |
| <b>DB10689<sup>a</sup></b>    | Back Window (Heated)(Solar) | 34.9x55.4 |

<sup>a</sup> Urethane,Dam,Primer - 2 Tubes  
<sup>b</sup> Fast-Cure Urethane/Dam/Primer - Quantity 2  
<sup>c</sup> Urethane,Dam,Primer - 1 Tube

**Monterey Mini Van..... 2006-2007**

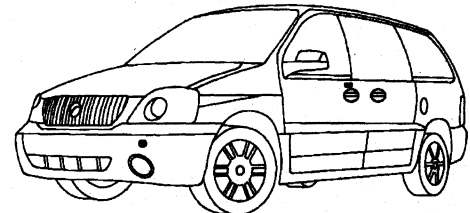

|                                |  |           |
|--------------------------------|--|-----------|
| <b>DW01527<sup>a b c</sup></b> | Windshield (Solar) (W/Third Visor Frit)        | 42.5x64.3 |
| <b>DD10206-07</b>              | Door F/R-L (Solar)                             | 26.2x35.9 |
| <b>DD10815<sup>d</sup></b>     | Door R/L (Solar) (Sliding Cargo Door)          | 24.0x40.2 |
| <b>DD10814<sup>d</sup></b>     | Door R/R (Solar) (Sliding Cargo Door)          | 24.0x44.8 |
| <b>DQ10817</b>                 | Quarter L (Solar) (W/LH Sliding Door, Movable) | 21.7x40.6 |
| <b>DQ10816</b>                 | Quarter R (Ant)(Solar) (Movable)               | 21.5x35.2 |
| <b>DB10511<sup>b</sup></b>     | Back Window (Heated)(Solar)                    | 28.5x58.7 |

<sup>a</sup> May Require Two Person Installation  
<sup>b</sup> Urethane,Dam,Primer - 2 Tubes  
<sup>c</sup> Fast-Cure Urethane/Dam/Primer - Quantity 2  
<sup>d</sup> Urethane,Dam,Primer - 1.5 Tubes

**Mountaineer 4 Door Utility..... 2006-2010**

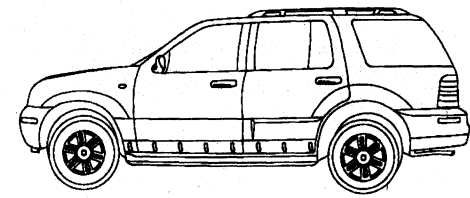

|                               |   |           |
|-------------------------------|---|-----------|
| <b>DW01619<sup>a b</sup></b>  | Windshield (Heated)(Solar) (W/Third Visor Frit) (07-08) | 33.2x64.4 |
| <b>DW01618<sup>a b</sup></b>  | Windshield (Solar) (W/Third Visor Frit)                 | 33.2x64.4 |
| <b>DD09870-71</b>             | Door F/R-L (Solar)                                      | 23.8x32.0 |
| <b>DD10942-43</b>             | Door R/R-L (Solar) (07-10)                              | 21.7x23.7 |
| <b>DD09872-73</b>             | Door R/R-L (Solar) (E-Mark) (06)                        | 21.7x23.7 |
| <b>DR10982</b>                | Roof (Solar)  | 16.3x31.8 |
| <b>DQ10946-47<sup>c</sup></b> | Quarter R-L (Encap)(Solar) (07-10)                      | 19.8x36.2 |
| <b>DQ10425-26<sup>c</sup></b> | Quarter R-L (Encap)(Solar) (Export Only, E-Mark)        | 19.8x36.2 |
| <b>DQ10424<sup>c</sup></b>    | Quarter R (Ant)(Encap)(Solar)                           | 19.8x36.2 |
| <b>DQ10422-23<sup>c</sup></b> | Quarter R-L (Encap)(Solar)                              | 19.8x36.2 |
| <b>DV10944-45</b>             | Vent R/R-L (Solar) (Black Moulding) (07-10)             | 9.7x19.6  |
| <b>DV10093-94</b>             | Vent R/R-L (Solar) (Chrome Moulding) (08-10)            | 9.7x19.6  |
| <b>DV09874-75</b>             | Vent R/R-L (Solar) (E-Mark) (06)                        | 9.7x19.6  |
| <b>DB10948</b>                | Back Window (Heated)(5 Holes)(Solar)                    | 22.0x55.0 |

<sup>a</sup> Urethane,Dam,Primer - 2 Tubes  
<sup>b</sup> Fast-Cure Urethane/Dam/Primer - Quantity 2  
<sup>c</sup> Urethane,Dam,Primer - 1.5 Tubes

**Sable 4 Door Sedan..... 2008-2009**

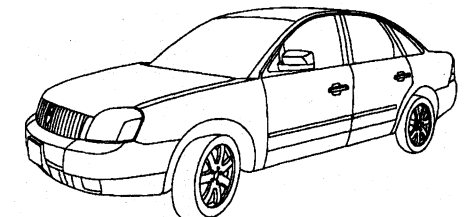

|                              |  |           |
|------------------------------|--|-----------|
| <b>DW01690<sup>a b</sup></b> | Windshield (Solar) (Electrochromic Mirror, W/Third Visor Frit) | 38.9x63.7 |
| <b>DD10683-84</b>            | Door F/R-L (Solar)   | 22.6x34.3 |

| <i>Sable</i>  | <i>(cont.)</i> |
|---|----------------|
| DD10685-86 Door R/R-L (Solar)                           | 22.2x30.3      |
| DR10690 Roof (Solar)                                    | 17.8x33.5      |
| DQ10687-88 <sup>c</sup> Quarter R-L (Encap)(Solar)      | 14.0x24.3      |
| DB11345 <sup>a</sup> Back Window (Ant)(Heated)(Solar)   | 34.9x55.4      |
| <sup>a</sup> Urethane,Dam,Primer - 2 Tubes              |                |
| <sup>b</sup> Fast-Cure Urethane/Dam/Primer - Quantity 2 |                |
| <sup>c</sup> Urethane,Dam,Primer - 1 Tube               |                |

**Mini**

**Cooper 2 Door Convertible ..... 2008-2011**

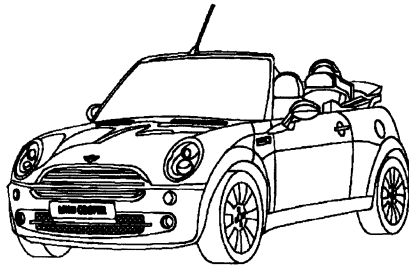

|   |           |
|---|-----------|
| FW02842 <sup>a</sup> Windshield (Heated)(Solar) (Rain Sensor) | 32.2x55.7 |
| FW02841 <sup>a</sup> Windshield (Solar) (Rain Sensor)         | 32.2x55.7 |
| FW02840 <sup>a</sup> Windshield (Solar)                       | 32.2x55.7 |
| FD23842-43 Door F/R-L (2 Holes)(Solar)                        | 18.0x38.5 |
| FQ23844-45 Quarter R-L (Encap)(Solar)                         | 16.5x18.0 |
| <sup>a</sup> Non-Conductive Urethane,Dam,Primer - 2 Tubes     |           |

**Cooper 2 Door Convertible ..... 2006-2007**

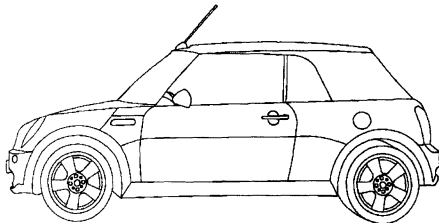

|   |           |
|---|-----------|
| FW02305 <sup>a</sup> Windshield (Rain Sensor)             | 32.2x55.7 |
| FW02304 <sup>a</sup> Windshield                           | 32.2x55.7 |
| FD21652-53 Door F/R-L                                     | 19.0x39.5 |
| FQ22720-21 Quarter R-L                                    |           |
| <sup>a</sup> Non-Conductive Urethane,Dam,Primer - 2 Tubes |           |

**Cooper 2 Door Hatchback ..... 2007-2011**

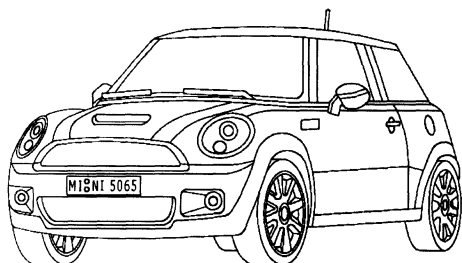

|   |           |
|---|-----------|
| FW02842 <sup>a</sup> Windshield (Heated)(Solar) (Rain Sensor) | 32.2x55.7 |
|---|-----------|

| <i>Cooper</i>  | <i>(cont.)</i> |
|--|----------------|
| FW02841 <sup>a</sup> Windshield (Solar) (Rain Sensor)          | 32.2x55.7      |
| FW02840 <sup>a</sup> Windshield (Solar)                        | 32.2x55.7      |
| FD23562-63 Door F/R-L (2 Holes)(Solar)                         | 22.0x41.7      |
| FQ23564-65 <sup>c</sup> Quarter R-L (Solar)                    | 16.4x33.5      |
| FB23566 <sup>b</sup> Back Window (Ant)(Heated)(1 Holes)(Solar) | 17.1x43.9      |
| <sup>a</sup> Non-Conductive Urethane,Dam,Primer - 2 Tubes      |                |
| <sup>b</sup> Non-Conductive Urethane,Dam,Primer - 1.5 Tubes    |                |
| <sup>c</sup> Non-Conductive Urethane,Dam,Primer - 1 Tube       |                |

**Cooper CLUBMAN 2 Door Hatchback ..... 2008-2011**

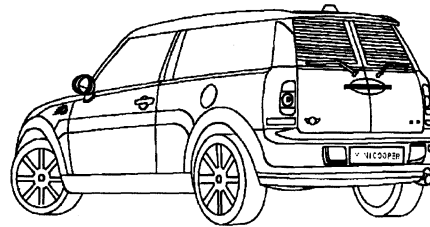

|   |           |
|---|-----------|
| FW02842 <sup>a</sup> Windshield (Heated)(Solar) (Rain Sensor) | 32.2x55.7 |
| FW02841 <sup>a</sup> Windshield (Solar) (Rain Sensor)         | 32.2x55.7 |
| FW02840 <sup>a</sup> Windshield (Solar)                       | 32.2x55.7 |
| FD23562-63 Door F/R-L (2 Holes)(Solar)                        | 22.0x41.7 |
| FD23846 Door R/R (Encap)(Solar) (Rear Access Door)            | 15.0x16.0 |
| FQ23848 <sup>b</sup> Quarter L (Ant)(Encap)(Solar)            | 15.0x46.5 |
| FQ23847 <sup>c</sup> Quarter R (Encap)(Solar)                 | 15.0x31.5 |
| FB23849-50 <sup>c</sup> Back Window R-L (Heated)(Solar)       | 14.0x20.5 |
| <sup>a</sup> Non-Conductive Urethane,Dam,Primer - 2 Tubes     |           |
| <sup>b</sup> Non-Conductive Urethane,Dam,Primer - 1.5 Tubes   |           |
| <sup>c</sup> Non-Conductive Urethane,Dam,Primer - 1 Tube      |           |

**Cooper 2 Door Hatchback ..... 2006**

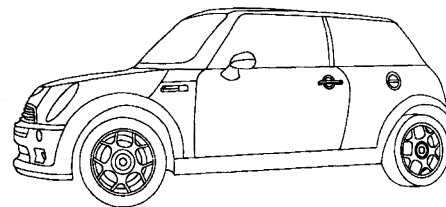

|   |           |
|---|-----------|
| FW02611 <sup>a</sup> Windshield (Heated) (Rain Sensor)            | 32.2x55.7 |
| FW02305 <sup>a</sup> Windshield (Rain Sensor)                     | 32.2x55.7 |
| FW02304 <sup>a</sup> Windshield                                   | 32.2x55.7 |
| FD21652-53 Door F/R-L   | 19.0x39.5 |
| FQ23193-94 <sup>b</sup> Quarter R-L (Ant)                         | 21.0x39.3 |
| FQ21654-55 <sup>b</sup> Quarter R-L                               | 15.7x41.7 |
| FB22778 <sup>b</sup> Back Window (Ant)(Heated)(1 Holes) (5 Leads) | 18.5x44.0 |
| <sup>a</sup> Non-Conductive Urethane,Dam,Primer - 2 Tubes         |           |
| <sup>b</sup> Non-Conductive Urethane,Dam,Primer - 1.5 Tubes       |           |



**Eclipse 2 Door Convertible..... 2007-2011**

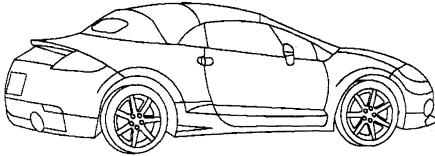

|   |                  |
|---|------------------|
| <b>FW02650<sup>a b</sup></b> Windshield (Solar) .....   | <b>34.0x58.5</b> |
| <b>FD23040-41</b> Door F/R-L (3 Holes)(Solar) .....     | <b>22.0x33.5</b> |
| <b>FQ23042-43</b> Quarter R-L (Solar) .....             | <b>13.0x22.0</b> |
| <b>FV22705-06</b> Vent F/R-L (Encap)(Solar) .....       | <b>12.5x15.0</b> |
| <sup>a</sup> Urethane,Dam,Primer - 2 Tubes              |                  |
| <sup>b</sup> Fast-Cure Urethane/Dam/Primer - Quantity 2 |                  |

**Eclipse 2 Door Coupe..... 2006-2011**

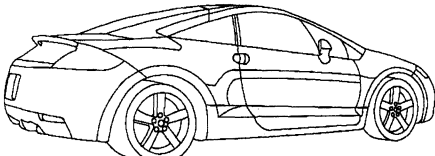

|   |                  |
|---|------------------|
| <b>FW02581<sup>a b e</sup></b> Windshield (Solar) .....           | <b>35.0x58.1</b> |
| <b>FD22700-01</b> Door F/R-L (3 Holes)(Solar) .....               | <b>22.0x32.8</b> |
| <b>FQ22702-03<sup>d</sup></b> Quarter R-L (Encap)(Solar) .....    | <b>10.3x22.0</b> |
| <b>FV22705-06</b> Vent F/R-L (Encap)(Solar) .....                 | <b>12.5x15.0</b> |
| <b>FB22704<sup>c</sup></b> Back Window (Ant)(Heated)(Solar) ..... | <b>37.0x42.3</b> |
| <sup>a</sup> Urethane,Dam,Primer - 2 Tubes                        |                  |
| <sup>b</sup> Fast-Cure Urethane/Dam/Primer - Quantity 2           |                  |
| <sup>c</sup> Urethane,Dam,Primer - 1.5 Tubes                      |                  |
| <sup>d</sup> Urethane,Dam,Primer - 1 Tube                         |                  |
| <sup>e</sup> Rain Sensor Kit (06)                                 |                  |

**Endeavor 4 Door Utility..... 2006-2011**

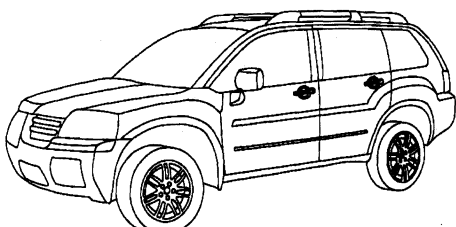

|   |                  |
|---|------------------|
| <b>FW02886<sup>a b</sup></b> Windshield (Solar) (07-11) .....             | <b>36.0x61.0</b> |
| <b>FW02393<sup>a b</sup></b> Windshield (Solar) (06) .....                | <b>36.0x61.0</b> |
| <b>FD21959-60</b> Door F/R-L (2 Holes)(Solar) .....                       | <b>21.0x33.5</b> |
| <b>FD21961-62</b> Door R/R-L (2 Holes)(Solar) .....                       | <b>21.0x27.0</b> |
| <b>FQ21963-64<sup>c</sup></b> Quarter R-L (Solar) .....                   | <b>16.8x27.5</b> |
| <b>FV22117-18<sup>c</sup></b> Vent F/R-L (Encap)(Solar) (White) .....     | <b>8.0x 8.5</b>  |
| <b>FV22115-16<sup>c</sup></b> Vent F/R-L (Encap)(Solar) (Silver) .....    | <b>8.0x 8.5</b>  |
| <b>FV22113-14<sup>c</sup></b> Vent F/R-L (Encap)(Solar) (Red) .....       | <b>8.0x 8.5</b>  |
| <b>FV22111-12<sup>c</sup></b> Vent F/R-L (Encap)(Solar) (Green) .....     | <b>8.0x 8.5</b>  |
| <b>FV22109-10<sup>c</sup></b> Vent F/R-L (Encap)(Solar) (Dark Gray) ..... | <b>8.0x 8.5</b>  |
| <b>FV22107-08<sup>c</sup></b> Vent F/R-L (Encap)(Solar) (Brown) .....     | <b>8.0x 8.5</b>  |
| <b>FV22105-06<sup>c</sup></b> Vent F/R-L (Encap)(Solar) (Blue) .....      | <b>8.0x 8.5</b>  |
| <b>FV21957-58<sup>c</sup></b> Vent F/R-L (Encap)(Solar) (Black) .....     | <b>8.0x 8.5</b>  |
| <b>FB24003</b> Back Window (Heated)(4 Holes)(Solar) (09-11) .....         | <b>22.0x55.0</b> |
| <b>FB23497</b> Back Window (Heated)(6 Holes)(Solar) (07-08) .....         | <b>22.0x55.0</b> |

**Endeavor (cont.)**

|   |                  |
|---|------------------|
| <b>FB21965</b> Back Window (Heated)(13 Holes)(Solar) (06) ..... | <b>22.0x55.0</b> |
| <sup>a</sup> Urethane,Dam,Primer - 2 Tubes                      |                  |
| <sup>b</sup> Fast-Cure Urethane/Dam/Primer - Quantity 2         |                  |
| <sup>c</sup> Urethane,Dam,Primer - 1 Tube                       |                  |

**Galant 4 Door Sedan..... 2011**

|  |                  |
|--|------------------|
| <b>FW03200<sup>a b</sup></b> Windshield (Solar) (W/Third Visor Frit) ..... | <b>37.0x59.0</b> |
| <b>FD24569-70</b> Door F/R-L (Solar) .....                                 | <b>18.0x34.5</b> |
| <b>FD24571-72</b> Door R/R-L (Solar) .....                                 | <b>18.0x26.0</b> |
| <b>FV24573-74</b> Vent R/R-L (Encap)(Solar) .....                          | <b>5.0x 8.0</b>  |
| <b>FB24575<sup>a</sup></b> Back Window (Ant)(Heated)(Solar) .....          | <b>31.0x52.0</b> |
| <sup>a</sup> Urethane,Dam,Primer - 2 Tubes                                 |                  |
| <sup>b</sup> Fast-Cure Urethane/Dam/Primer - Quantity 2                    |                  |

**Galant 4 Door Sedan..... 2006-2010**

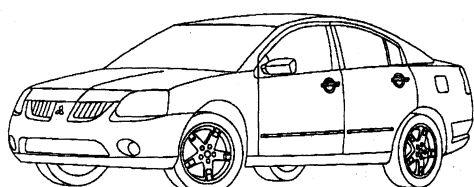

|  |                  |
|--|------------------|
| <b>FW02428<sup>a b</sup></b> Windshield (Solar) .....  | <b>36.0x60.0</b> |
| <b>FD22129-30</b> Door F/R-L (Solar) .....   | <b>18.5x36.5</b> |
| <b>FD22131-32</b> Door R/R-L (Solar) .....   | <b>18.0x26.5</b> |
| <b>FV22133-34</b> Vent R/R-L (Encap)(Solar) .....  | <b>5.3x 9.0</b>  |
| <b>FB23947<sup>a</sup></b> Back Window (Ant)(Heated)(Solar) (09-10) .....                          | <b>32.8x51.8</b> |
| <b>FB22136<sup>c</sup></b> Back Window (Ant)(Heated)(Solar) (W/Diversity<br>Antenna) (06-08) ..... | <b>32.5x46.5</b> |
| <b>FB22135<sup>c</sup></b> Back Window (Ant)(Heated)(Solar) (06-08) .....                          | <b>32.5x46.5</b> |
| <sup>a</sup> Urethane,Dam,Primer - 2 Tubes   |                  |
| <sup>b</sup> Fast-Cure Urethane/Dam/Primer - Quantity 2  |                  |
| <sup>c</sup> Urethane,Dam,Primer - 1.5 Tubes   |                  |

**Grandis 4 Door Station Wagon (MEXICO Only). 2007-2010**

|   |  |
|---|--|
| <b>FW02740<sup>a b</sup></b> Windshield (Solar) (W/Third Visor Frit, Mexico Only) .....         |  |
| <b>FD23418-19</b> Door F/R-L (Solar) (Mexico Only) .....  |  |
| <b>FD23420-21</b> Door R/R-L (Solar) (Mexico Only) .....  |  |
| <b>FQ23422-23<sup>c</sup></b> Quarter R-L (Encap)(Solar) (Mexico Only) .....                    |  |
| <b>FV23416-17<sup>c</sup></b> Vent F/R-L (Encap)(Solar) (Mexico Only) .....                     |  |
| <b>FB23424<sup>c</sup></b> Back Window (Heated)(1 Holes)(Solar) (Mexico Only,<br>W/Wiper) ..... |  |
| <sup>a</sup> Urethane,Dam,Primer - 2 Tubes  |  |
| <sup>b</sup> Fast-Cure Urethane/Dam/Primer - Quantity 2   |  |
| <sup>c</sup> Urethane,Dam,Primer - 1.5 Tubes  |  |

**L200 4 Door Crew Cab (MEXICO Only)..... 2008-2011**

|  |  |
|--|--|
| <b>FW03005<sup>a b</sup></b> Windshield (Solar) (Mexico Only) .....            |  |
| <b>FD24045-46</b> Door F/R-L (Solar) (Mexico Only) .....                       |  |
| <b>FD24047-48</b> Door R/R-L (Solar) (Mexico Only) .....                       |  |
| <b>FV24058-59</b> Vent R/R-L (Solar) (Mexico Only) .....                       |  |
| <b>FB24049<sup>c</sup></b> Back Window (Solar) (Stationary, Mexico Only) ..... |  |
| <sup>a</sup> Urethane,Dam,Primer - 2 Tubes                                     |  |
| <sup>b</sup> Fast-Cure Urethane/Dam/Primer - Quantity 2                        |  |
| <sup>c</sup> Urethane,Dam,Primer - 1.5 Tubes                                   |  |

**Lancer 4 Door Hatchback..... 2009-2011**

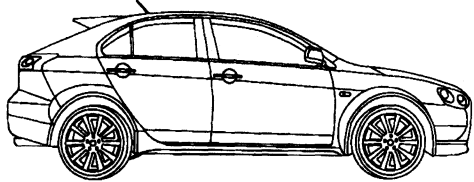

|   |                  |
|---|------------------|
| <b>FW03060<sup>a b d</sup></b> Windshield (W/Third Visor Frit, Rain Sensor) ..... | <b>40.2x56.8</b> |
| <b>FW02833<sup>a b</sup></b> Windshield (W/Third Visor Frit) .....                | <b>40.2x56.8</b> |
| <b>FD23550-51</b> Door F/R-L .....  | <b>20.0x38.0</b> |
| <b>FD23552-53</b> Door R/R-L .....  | <b>18.5x23.5</b> |
| <b>FV23554-55</b> Vent R/R-L .....  | <b>10.0x10.5</b> |
| <b>FB24568<sup>c</sup></b> Back Window (Heated)(1 Holes) (W/Wiper) .....          | <b>32.5x45.0</b> |

<sup>a</sup> Urethane,Dam,Primer - 2 Tubes  
<sup>b</sup> Fast-Cure Urethane/Dam/Primer - Quantity 2  
<sup>c</sup> Urethane,Dam,Primer - 1.5 Tubes  
<sup>d</sup> Rain Sensor Kit

**Lancer 4 Door Sedan..... 2008-2011**

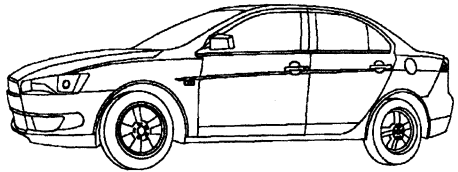

|   |                  |
|---|------------------|
| <b>FW03060<sup>a b d</sup></b> Windshield (W/Third Visor Frit, Rain Sensor) (09-11) ..... | <b>40.2x56.8</b> |
| <b>FW02833<sup>a b</sup></b> Windshield (W/Third Visor Frit) .....                        | <b>40.2x56.8</b> |
| <b>FD23550-51</b> Door F/R-L .....  | <b>20.0x38.0</b> |
| <b>FD23552-53</b> Door R/R-L .....  | <b>18.5x23.5</b> |
| <b>FV23554-55</b> Vent R/R-L .....  | <b>10.0x10.5</b> |
| <b>FB23556<sup>c</sup></b> Back Window (Heated) .....                                     | <b>29.0x50.8</b> |

<sup>a</sup> Urethane,Dam,Primer - 2 Tubes  
<sup>b</sup> Fast-Cure Urethane/Dam/Primer - Quantity 2  
<sup>c</sup> Urethane,Dam,Primer - 1.5 Tubes  
<sup>d</sup> Rain Sensor Kit

**Lancer 4 Door Sedan..... 2006-2007**

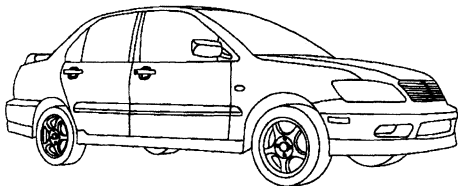

|   |                  |
|---|------------------|
| <b>FW02455<sup>a b c</sup></b> Windshield (Solar) (W/Third Visor Frit) .....  | <b>37.5x57.0</b> |
| <b>FD21441-42</b> Door F/R-L .....  | <b>21.0x35.0</b> |
| <b>FD21443-44</b> Door R/R-L .....  | <b>20.0x26.0</b> |
| <b>FV21445-46</b> Vent R/R-L .....  | <b>8.3x12.0</b>  |
| <b>FB22601<sup>d</sup></b> Back Window (Heated)(1 Holes) (W/Wiper) (06) ..... | <b>26.0x52.0</b> |
| <b>FB21447<sup>d</sup></b> Back Window (Heated) .....                         | <b>26.0x52.0</b> |

<sup>a</sup> Chrysler Bullet w/Notch Mirror Button  
<sup>b</sup> Urethane,Dam,Primer - 2 Tubes  
<sup>c</sup> Fast-Cure Urethane/Dam/Primer - Quantity 2  
<sup>d</sup> Urethane,Dam,Primer - 1.5 Tubes

**Lancer 4 Door Station Wagon..... 2006-2007**

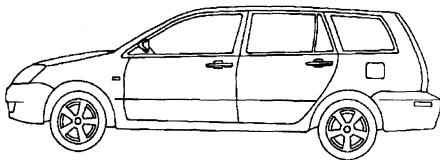

|  |                  |
|--|------------------|
| <b>FW02455<sup>a b c</sup></b> Windshield (Solar) (W/Third Visor Frit) ..... | <b>37.5x57.0</b> |
| <b>FD21441-42</b> Door F/R-L .....   | <b>21.0x35.0</b> |
| <b>FD22252-53</b> Door R/R-L .....   | <b>19.0x27.0</b> |
| <b>FQ22256-57<sup>e</sup></b> Quarter R-L (Encap) .....                      | <b>15.0x25.5</b> |
| <b>FV22254-55</b> Vent R/R-L .....   | <b>7.8x16.0</b>  |
| <b>FB22258<sup>d</sup></b> Back Window (Heated)(1 Holes) .....               | <b>18.3x50.0</b> |

<sup>a</sup> Chrysler Bullet w/Notch Mirror Button  
<sup>b</sup> Urethane,Dam,Primer - 2 Tubes  
<sup>c</sup> Fast-Cure Urethane/Dam/Primer - Quantity 2  
<sup>d</sup> Urethane,Dam,Primer - 1.5 Tubes  
<sup>e</sup> Urethane,Dam,Primer - 1 Tube

**Montero 4 Door Utility (MEXICO Only)..... 2008-2010**

|  |       |
|--|-------|
| <b>FW03126<sup>a b</sup></b> Windshield (Solar) (Mexico Only, Rain Sensor) .....   | ..... |
| <b>FW03125<sup>a b</sup></b> Windshield (Heated)(Solar) (Mexico Only, Acoustic Interlayer, Heated Wiper Park Area) ..... | ..... |
| <b>FW03124<sup>a b</sup></b> Windshield (Solar) (Mexico Only, Acoustic Interlayer) .....                                 | ..... |
| <b>FD24373-74</b> Door F/R-L (Solar) (Mexico Only) .....   | ..... |
| <b>FD24375-76</b> Door R/R-L (Solar) (Mexico Only) .....   | ..... |
| <b>FQ24379-80</b> Quarter R-L (Solar) (Mexico Only) .....  | ..... |
| <b>FV24377-78</b> Vent R/R-L (Solar) (Mexico Only) .....   | ..... |
| <b>FB24381<sup>c</sup></b> Back Window (Heated)(Solar) (Mexico Only) .....   | ..... |

<sup>a</sup> Urethane,Dam,Primer - 2 Tubes  
<sup>b</sup> Fast-Cure Urethane/Dam/Primer - Quantity 2  
<sup>c</sup> Urethane,Dam,Primer - 1.5 Tubes

**Montero 4 Door Utility..... 2006**

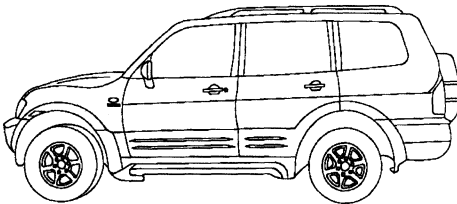

|  |                  |
|--|------------------|
| <b>FW02407<sup>a b</sup></b> Windshield .....                    | <b>30.3x59.3</b> |
| <b>FD21036-37</b> Door F/R-L (2 Holes) .....                     | <b>25.0x31.5</b> |
| <b>FD21038-39</b> Door R/R-L (2 Holes)(Solar) .....              | <b>24.0x26.0</b> |
| <b>FQ21042-43<sup>d</sup></b> Quarter R-L (1 Holes)(Solar) ..... | <b>19.3x26.5</b> |
| <b>FV21040-41</b> Vent R/R-L (Solar) .....                       | <b>11.5x19.5</b> |
| <b>FB21044<sup>c</sup></b> Back Window (Heated)(Solar) .....     | <b>24.0x51.5</b> |

<sup>a</sup> Urethane,Dam,Primer - 2 Tubes  
<sup>b</sup> Fast-Cure Urethane/Dam/Primer - Quantity 2  
<sup>c</sup> Urethane,Dam,Primer - 1.5 Tubes  
<sup>d</sup> Urethane,Dam,Primer - 1 Tube

**Montero Sport 4 Door Utility (MEXICO Only).. 2008-2011**

|   |       |
|---|-------|
| <b>FW03005<sup>a b</sup></b> Windshield (Solar) (Mexico Only) .....   | ..... |
| <b>FD24045-46</b> Door F/R-L (Solar) (Mexico Only) .....              | ..... |
| <b>FD24859-60</b> Door R/R-L (Solar) (Mexico Only) .....              | ..... |
| <b>FQ24863-64<sup>c</sup></b> Quarter R-L (Solar) (Mexico Only) ..... | ..... |

**Montero Sport (cont.)**

- FW24861-62 Vent R/R-L (Solar) (Mexico Only) .....
- FB24865<sup>c</sup> Back Window (Heated)(1 Holes)(Solar) (Mexico Only, W/Wiper) .....
- <sup>a</sup> Urethane,Dam,Primer - 2 Tubes
- <sup>b</sup> Fast-Cure Urethane/Dam/Primer - Quantity 2
- <sup>c</sup> Urethane,Dam,Primer - 1.5 Tubes

**Montero Sport 4 Door Utility..... 2006-2007**

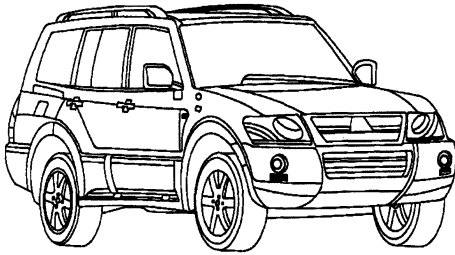

- FW02259<sup>a b</sup> Windshield ..... 27.0x58.0
- FD20213-14 Door F/R-L ..... 24.0x30.0
- FD20215-16 Door R/R-L ..... 24.0x24.2
- FQ20221<sup>d</sup> Quarter L (Ant) ..... 18.0x35.0
- FQ20219-20<sup>d</sup> Quarter R-L ..... 18.0x35.0
- FV20217-18 Vent R/R-L ..... 8.0x17.8
- FB20222<sup>c</sup> Back Window (Heated) ..... 23.0x52.0
- <sup>a</sup> Urethane,Dam,Primer - 2 Tubes
- <sup>b</sup> Fast-Cure Urethane/Dam/Primer - Quantity 2
- <sup>c</sup> Urethane,Dam,Primer - 1.5 Tubes
- <sup>d</sup> Urethane,Dam,Primer - 1 Tube

**Outlander 4 Door Utility..... 2007-2011**

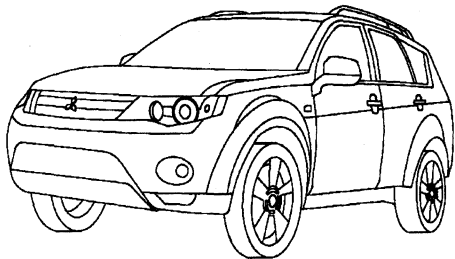

- FW03061<sup>a b d</sup> Windshield (W/Third Visor Frit, Rain Sensor) (09-11) 36.0x58.0
- FW02750<sup>a b</sup> Windshield (W/Third Visor Frit) ..... 36.0x58.0
- FD23443-44 Door F/R-L ..... 22.3x36.0
- FD23445-46 Door R/R-L (Solar) ..... 19.5x28.8
- FQ24788-89<sup>c</sup> Quarter R-L (Encap)(Solar) (Chrome Moulding) (10-11) ..... 15.0x22.3
- FQ23447-48<sup>c</sup> Quarter R-L (Encap)(Solar) (Black Moulding) ..... 15.0x22.3
- FB23449<sup>c</sup> Back Window (Heated)(1 Holes)(Solar) (W/Wiper) ... 19.0x59.0
- <sup>a</sup> Urethane,Dam,Primer - 2 Tubes
- <sup>b</sup> Fast-Cure Urethane/Dam/Primer - Quantity 2
- <sup>c</sup> Urethane,Dam,Primer - 1.5 Tubes
- <sup>d</sup> Rain Sensor Kit
- <sup>e</sup> Urethane,Dam,Primer - 1 Tube

**Outlander 4 Door Utility..... 2006**

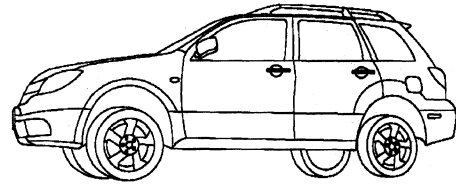

- FW02499<sup>a b</sup> Windshield ..... 36.3x54.5
- FD21866-67 Door F/R-L ..... 19.0x33.5
- FD21870-71 Door R/R-L (Solar) ..... 19.0x27.5
- FD21868-69 Door R/R-L ..... 19.0x27.5
- FQ21874-75<sup>d</sup> Quarter R-L (Encap)(Solar) ..... 15.5x23.0
- FQ21872-73<sup>d</sup> Quarter R-L (Encap) ..... 15.5x23.0
- FB22677<sup>c</sup> Back Window (Heated)(Solar) ..... 20.3x57.8
- FB22676<sup>c</sup> Back Window (Heated) ..... 20.3x57.8
- <sup>a</sup> Urethane,Dam,Primer - 2 Tubes
- <sup>b</sup> Fast-Cure Urethane/Dam/Primer - Quantity 2
- <sup>c</sup> Urethane,Dam,Primer - 1.5 Tubes
- <sup>d</sup> Urethane,Dam,Primer - 1 Tube

**Raider 2 Door Extended Cab..... 2006-2009**

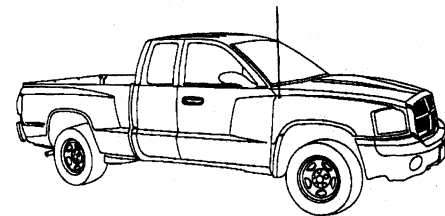

- DW01590<sup>a b</sup> Windshield (W/Third Visor Frit) ..... 35.0x62.5
- DD10777-78 Door F/R-L ..... 19.0x29.0
- DQ10781-82<sup>d</sup> Quarter R-L (Solar) ..... 13.9x17.9
- DB10449 Back Window C (Slider)(Solar) (OE, Movable) ..... 13.0x13.2
- DY90088<sup>c</sup> Back Window (Encap)(Slider)(Solar) (Black Frame, Aftermarket, 3 Panel Encapsulated) ..... 15.6x56.0
- DY90087<sup>c</sup> Back Window (Encap)(Slider)(Solar) (Black Frame, Aftermarket, 4 Panel Encapsulated) ..... 15.6x56.0
- DY90083<sup>c</sup> Back Window (Encap)(Slider) (Aftermarket, Power, 3 Panel Encapsulated) ..... 15.6x56.0
- DY90082<sup>c</sup> Back Window (Encap)(Slider) (Aftermarket, 3 Panel Encapsulated) ..... 15.6x56.0
- DB10784<sup>c</sup> Back Window (Heated)(Solar) (Stationary) ..... 15.6x56.0
- DB10783<sup>c</sup> Back Window (Stationary) ..... 15.6x56.0
- DB10448<sup>c</sup> Back Window (Slider)(Solar) (OE) ..... 15.6x56.0
- <sup>a</sup> Urethane,Dam,Primer - 2 Tubes
- <sup>b</sup> Fast-Cure Urethane/Dam/Primer - Quantity 2
- <sup>c</sup> Urethane,Dam,Primer - 1.5 Tubes
- <sup>d</sup> Foam Core Butyl Tape - Quantity 1

**Raider 4 Door Crew Cab..... 2006-2009**

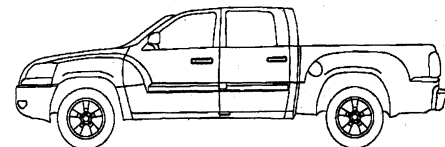

- DW01590<sup>a b</sup> Windshield (W/Third Visor Frit) ..... 35.0x62.5
- DD10777-78 Door F/R-L ..... 19.0x29.0
- DD10779-80 Door R/R-L (Solar) ..... 23.0x24.5
- DB10449 Back Window C (Slider)(Solar) (OE, Movable) ..... 13.0x13.2

| <b>Raider (cont.)</b>  |           |
|--|-----------|
| DY90088 <sup>c</sup> Back Window (Encap)(Slider)(Solar) (Black Frame, Aftermarket, 3 Panel Encapsulated) ..... | 15.6x56.0 |
| DY90087 <sup>c</sup> Back Window (Encap)(Slider)(Solar) (Black Frame, Aftermarket, 4 Panel Encapsulated) ..... | 15.6x56.0 |
| DY90083 <sup>c</sup> Back Window (Encap)(Slider) (Aftermarket, Power, 3 Panel Encapsulated) .....              | 15.6x56.0 |
| DY90082 <sup>c</sup> Back Window (Encap)(Slider) (Aftermarket, 3 Panel Encapsulated) .....                     | 15.6x56.0 |
| DB10784 <sup>c</sup> Back Window (Heated)(Solar) (Stationary) .....  | 15.6x56.0 |
| DB10783 <sup>c</sup> Back Window (Stationary) .....  | 15.6x56.0 |
| DB10448 <sup>c</sup> Back Window (Slider)(Solar) (OE) .....  | 15.6x56.0 |

<sup>a</sup> Urethane,Dam,Primer - 2 Tubes  
<sup>b</sup> Fast-Cure Urethane/Dam/Primer - Quantity 2  
<sup>c</sup> Urethane,Dam,Primer - 1.5 Tubes

**350Z 2 Door Convertible..... 2006-2008**

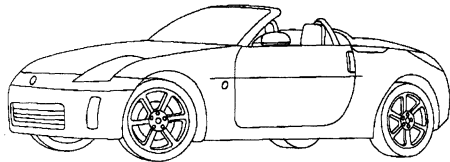

|  |           |
|--|-----------|
| FW02348 <sup>a b</sup> Windshield .....      | 30.4x60.6 |
| FD22138-39 Door F/R-L (2 Holes)(Solar) ..... | 22.0x36.3 |

<sup>a</sup> Urethane,Dam,Primer - 2 Tubes  
<sup>b</sup> Fast-Cure Urethane/Dam/Primer - Quantity 2

**350Z 2 Door Coupe..... 2006-2008**

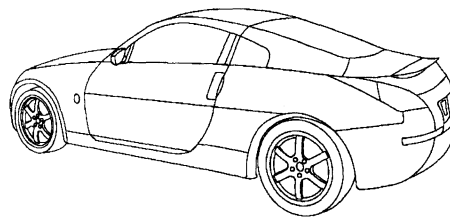

|  |           |
|--|-----------|
| FW02348 <sup>a b</sup> Windshield .....                              | 30.4x60.6 |
| FD21799-00 Door F/R-L (2 Holes)(Solar) .....                         | 21.0x34.0 |
| FQ21801-02 <sup>d</sup> Quarter R-L (Encap)(Solar) .....             | 10.0x15.0 |
| FB21803 <sup>c</sup> Back Window (Ant)(Heated)(1 Holes)(Solar) ..... | 33.5x42.3 |

<sup>a</sup> Urethane,Dam,Primer - 2 Tubes  
<sup>b</sup> Fast-Cure Urethane/Dam/Primer - Quantity 2  
<sup>c</sup> Urethane,Dam,Primer - 1.5 Tubes  
<sup>d</sup> Urethane,Dam,Primer - 1 Tube

**370Z 2 Door Convertible..... 2010-2011**

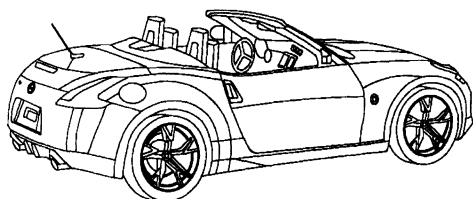

|  |  |
|--|--|
| FW03227 <sup>a b</sup> Windshield (Solar) (W/Third Visor Frit) ..... |  |
|--|--|

| <b>370Z (cont.)</b>                                     |  |
|---|--|
| FD24611-12 Door F/R-L (Solar) .....                     |  |
| <sup>a</sup> Urethane,Dam,Primer - 2 Tubes              |  |
| <sup>b</sup> Fast-Cure Urethane/Dam/Primer - Quantity 2 |  |

**370Z 2 Door Coupe..... 2009-2011**

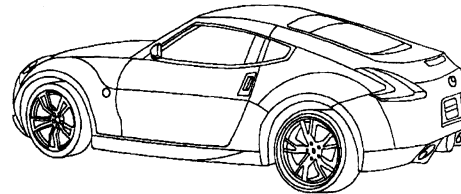

|   |           |
|---|-----------|
| FW03041 <sup>a b</sup> Windshield (Solar) .....             | 31.0x58.0 |
| FD24140-41 Door F/R-L (Solar) .....                         | 15.0x33.0 |
| FQ24142-43 <sup>d</sup> Quarter R-L (Encap)(Solar) .....    | 9.0x10.0  |
| FB24144 <sup>c</sup> Back Window (Ant)(Heated)(Solar) ..... | 34.0x44.0 |

<sup>a</sup> Urethane,Dam,Primer - 2 Tubes  
<sup>b</sup> Fast-Cure Urethane/Dam/Primer - Quantity 2  
<sup>c</sup> Urethane,Dam,Primer - 1.5 Tubes  
<sup>d</sup> Urethane,Dam,Primer - 1 Tube

**Almera 2 Door Hatchback (MEXICO Only)..... 2006**

|   |  |
|---|--|
| FW02297 <sup>a b</sup> Windshield (Solar) (Mexico Only) .....   |  |
| FD21594-95 Door F/R-L (Solar) (Mexico Only) .....               |  |
| FQ21596-97 <sup>c</sup> Quarter R-L (Solar) (Mexico Only) ..... |  |
| FB21604 <sup>c</sup> Back Window (Solar) (Mexico Only) .....    |  |

<sup>a</sup> Urethane,Dam,Primer - 2 Tubes  
<sup>b</sup> Fast-Cure Urethane/Dam/Primer - Quantity 2  
<sup>c</sup> Urethane,Dam,Primer - 1.5 Tubes

**Almera 4 Door Hatchback (MEXICO Only)..... 2006**

|   |  |
|---|--|
| FW02297 <sup>a b</sup> Windshield (Solar) (Mexico Only) ..... |  |
| FD21598-99 Door F/R-L (Solar) (Mexico Only) .....             |  |
| FD21600-01 Door R/R-L (Solar) (Mexico Only) .....             |  |
| FV21602-03 Vent R/R-L (Solar) (Mexico Only) .....             |  |
| FB21604 <sup>c</sup> Back Window (Solar) (Mexico Only) .....  |  |

<sup>a</sup> Urethane,Dam,Primer - 2 Tubes  
<sup>b</sup> Fast-Cure Urethane/Dam/Primer - Quantity 2  
<sup>c</sup> Urethane,Dam,Primer - 1.5 Tubes

**Altima 2 Door Coupe..... 2008-2011**

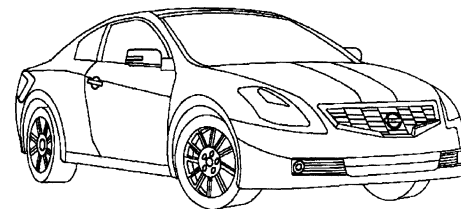

|   |           |
|---|-----------|
| FW02822 <sup>a b</sup> Windshield (Solar) (W/Third Visor Frit) .....              | 39.0x57.0 |
| FD23533-34 Door F/R-L (Solar) .....   | 20.0x46.0 |
| FQ23535-36 <sup>c</sup> Quarter R-L (Encap)(Solar) .....                          | 12.0x17.0 |
| FB23538 <sup>a</sup> Back Window (Ant)(Heated)(Solar) (W/Diversity Antenna) ..... | 32.5x50.0 |
| FB23537 <sup>a</sup> Back Window (Ant)(Heated)(Solar) .....                       | 32.5x50.0 |

<sup>a</sup> Urethane,Dam,Primer - 2 Tubes  
<sup>b</sup> Fast-Cure Urethane/Dam/Primer - Quantity 2

**Altima (cont.)**

<sup>c</sup> Urethane,Dam,Primer - 1 Tube

---

**Altima 4 Door Sedan ..... 2007-2011**

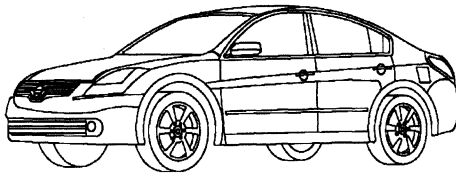

|  |                  |
|--|------------------|
| <b>FW02734<sup>a b</sup></b> Windshield (Solar) (W/Third Visor Frit) .....                                   | <b>38.5x57.0</b> |
| <b>FD23387-88</b> Door F/R-L (Solar) .....   | <b>22.0x39.8</b> |
| <b>FD23389-90</b> Door R/R-L (Solar) .....   | <b>19.0x29.5</b> |
| <b>FV23391-92</b> Vent R/R-L (Solar) .....   | <b>7.5x11.0</b>  |
| <b>FB24133<sup>a</sup></b> Back Window (Ant)(Heated)(Solar) (Hybrid, W/Diversity Antenna) .....              | <b>34.3x48.0</b> |
| <b>FB23394<sup>a</sup></b> Back Window (Ant)(Heated)(Solar) (W/Diversity Antenna, W/Bluetooth Antenna) ..... | <b>34.3x48.0</b> |
| <b>FB23393<sup>a</sup></b> Back Window (Ant)(Heated)(Solar) (W/Diversity Antenna) .....                      | <b>34.3x48.0</b> |

<sup>a</sup> Urethane,Dam,Primer - 2 Tubes  
<sup>b</sup> Fast-Cure Urethane/Dam/Primer - Quantity 2

**Altima 4 Door Sedan ..... 2006**

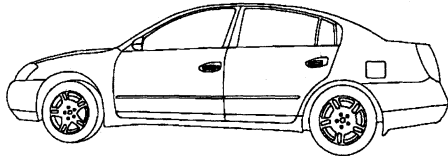

|   |                  |
|---|------------------|
| <b>FW02281<sup>a b</sup></b> Windshield (Solar) .....             | <b>38.0x58.3</b> |
| <b>FD21488-89</b> Door F/R-L (Solar) .....                        | <b>19.0x35.3</b> |
| <b>FD21490-91</b> Door R/R-L (Solar) .....                        | <b>19.0x31.5</b> |
| <b>FV21492-93</b> Vent R/R-L (Solar) .....                        | <b>7.5x11.0</b>  |
| <b>FB21494<sup>c</sup></b> Back Window (Ant)(Heated)(Solar) ..... | <b>31.0x49.8</b> |

<sup>a</sup> Urethane,Dam,Primer - 2 Tubes  
<sup>b</sup> Fast-Cure Urethane/Dam/Primer - Quantity 2  
<sup>c</sup> Urethane,Dam,Primer - 1.5 Tubes

**Aprio 4 Door Sedan (MEXICO Only)..... 2008-2010**

|   |  |
|---|--|
| <b>FW02962<sup>a b</sup></b> Windshield (W/Third Visor Frit, Mexico Only) ..... |  |
| <b>FD23940-41</b> Door F/R-L (Mexico Only) .....                                |  |
| <b>FD23942-43</b> Door R/R-L (Mexico Only) .....                                |  |
| <b>FB23944<sup>c</sup></b> Back Window (Heated) (Mexico Only) .....             |  |

<sup>a</sup> Urethane,Dam,Primer - 2 Tubes  
<sup>b</sup> Fast-Cure Urethane/Dam/Primer - Quantity 2  
<sup>c</sup> Urethane,Dam,Primer - 1.5 Tubes

**Armada 4 Door Utility..... 2006-2010**

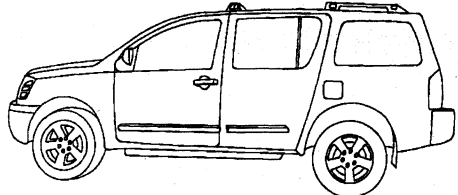

|   |                  |
|---|------------------|
| <b>FW02391<sup>a b c</sup></b> Windshield .....           | <b>34.8x63.9</b> |
| <b>FD21945-46</b> Door F/R-L .....                        | <b>27.2x39.2</b> |
| <b>FD22144-45</b> Door R/R-L (Solar) .....                | <b>26.3x30.2</b> |
| <b>FQ22150-51</b> Quarter R-L (Ant)(Solar) (Power) .....  | <b>19.1x36.1</b> |
| <b>FQ22148-49</b> Quarter R-L (Ant)(Solar) (Manual) ..... | <b>19.1x36.1</b> |
| <b>FV22146-47</b> Vent R/R-L (Solar) .....                | <b>8.6x20.4</b>  |
| <b>FB22153</b> Back Window (Heated)(Solar) .....          | <b>20.1x60.2</b> |

<sup>a</sup> May Require Two Person Installation  
<sup>b</sup> Urethane,Dam,Primer - 2 Tubes  
<sup>c</sup> Fast-Cure Urethane/Dam/Primer - Quantity 2

**Cube 4 Door Utility ..... 2009-2011**

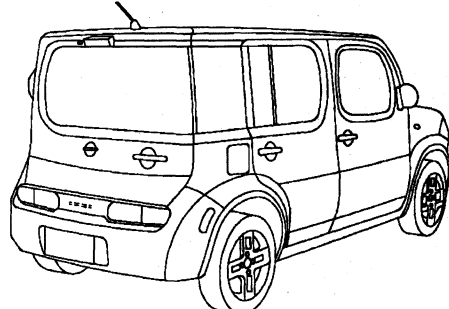

|  |                  |
|--|------------------|
| <b>FW03103<sup>a b</sup></b> Windshield (Solar) (W/Third Visor Frit) ..... | <b>28.0x59.0</b> |
| <b>FD24306-07</b> Door F/R-L (Solar) .....                                 | <b>22.3x34.5</b> |
| <b>FD24308-09</b> Door R/R-L (Solar) .....                                 | <b>19.0x20.0</b> |
| <b>FQ24312<sup>d</sup></b> Quarter R (Solar) .....                         | <b>17.0x18.0</b> |
| <b>FV24310-11</b> Vent R/R-L (Solar) .....                                 | <b>9.0x18.0</b>  |
| <b>FB24313<sup>c</sup></b> Back Window (Heated)(Solar) .....               | <b>18.0x47.0</b> |

<sup>a</sup> Urethane,Dam,Primer - 2 Tubes  
<sup>b</sup> Fast-Cure Urethane/Dam/Primer - Quantity 2  
<sup>c</sup> Urethane,Dam,Primer - 1.5 Tubes  
<sup>d</sup> Urethane,Dam,Primer - 1 Tube

**Frontier 4 Door Crew Cab (MEXICO Only) ..... 2006-2008**

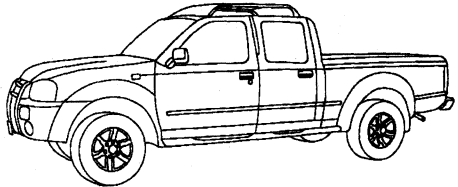

|  |                  |
|--|------------------|
| <b>FW02229<sup>a b c</sup></b> Windshield .....  | <b>29.5x58.0</b> |
| <b>FD21237-38</b> Door F/R-L .....   | <b>21.5x35.5</b> |
| <b>FD20774-75</b> Door R/R-L (Solar) .....   | <b>21.0x23.0</b> |
| <b>FY95042<sup>d</sup></b> Back Window (Encap)(Slider)(Solar) (Black Frame, Aftermarket, 3 Panel Encapsulated) ..... | <b>15.0x54.1</b> |
| <b>FY95041<sup>d</sup></b> Back Window (Encap)(Slider) (Black Frame, Aftermarket, 3 Panel Encapsulated) .....        | <b>15.0x54.1</b> |
| <b>FB21347<sup>d</sup></b> Back Window (Encap)(Heated)(Solar) (Stationary) ...                                       | <b>15.0x53.3</b> |

**Frontier** (cont.)

<sup>a</sup> Mirror Button change from FW02070  
<sup>b</sup> Urethane,Dam,Primer - 2 Tubes  
<sup>c</sup> Fast-Cure Urethane/Dam/Primer - Quantity 2  
<sup>d</sup> Urethane,Dam,Primer - 1.5 Tubes

**Frontier Pickup 2 Door Extended Cab..... 2006-2011**

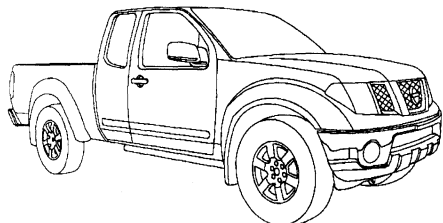

|                               |   |                  |
|-------------------------------|---|------------------|
| <b>FW02510<sup>a b</sup></b>  | Windshield (Solar) .....  | <b>33.1x60.2</b> |
| <b>FD22456-57</b>             | Door F/R-L (Solar) .....  | <b>23.5x32.6</b> |
| <b>FQ22476-77<sup>d</sup></b> | Quarter R-L (Solar) .....   | <b>14.5x20.0</b> |
| <b>FY95052<sup>c</sup></b>    | Back Window (Encap)(Slider)(Solar) (Black Frame, Aftermarket, Power, 3 Panel Encapsulated) .....  | <b>16.0x58.0</b> |
| <b>FY95051<sup>c</sup></b>    | Back Window (Encap)(Slider)(Solar) (Black Frame, Aftermarket, Manual, 3 Panel Encapsulated) ..... | <b>16.0x58.0</b> |
| <b>FB22821<sup>c</sup></b>    | Back Window (Solar) (Stationary) .....  | <b>16.0x58.0</b> |
| <b>FB22603<sup>c</sup></b>    | Back Window (Slider)(Solar) (OE) .....  | <b>16.0x58.0</b> |
| <b>FB22478<sup>c</sup></b>    | Back Window (Heated)(Solar) (Stationary) .....  | <b>16.0x58.0</b> |

<sup>a</sup> Urethane,Dam,Primer - 2 Tubes  
<sup>b</sup> Fast-Cure Urethane/Dam/Primer - Quantity 2  
<sup>c</sup> Urethane,Dam,Primer - 1.5 Tubes  
<sup>d</sup> Urethane,Dam,Primer - 1 Tube

**Frontier Pickup 4 Door Crew Cab ..... 2006-2011**

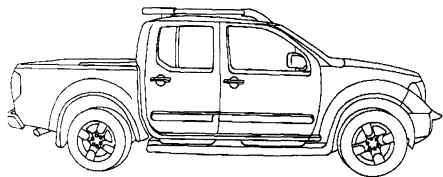

|                              |   |                  |
|------------------------------|---|------------------|
| <b>FW02510<sup>a b</sup></b> | Windshield (Solar) .....  | <b>33.1x60.2</b> |
| <b>FD22456-57</b>            | Door F/R-L (Solar) .....  | <b>23.5x32.6</b> |
| <b>FD22458-59</b>            | Door R/R-L (Solar) .....  | <b>16.7x22.6</b> |
| <b>FV22460-61</b>            | Vent R/R-L (Solar) .....  | <b>8.0x19.5</b>  |
| <b>FY95052<sup>c</sup></b>   | Back Window (Encap)(Slider)(Solar) (Black Frame, Aftermarket, Power, 3 Panel Encapsulated) .....  | <b>16.0x58.0</b> |
| <b>FY95051<sup>c</sup></b>   | Back Window (Encap)(Slider)(Solar) (Black Frame, Aftermarket, Manual, 3 Panel Encapsulated) ..... | <b>16.0x58.0</b> |
| <b>FB22821<sup>c</sup></b>   | Back Window (Solar) (Stationary) .....  | <b>16.0x58.0</b> |
| <b>FB22603<sup>c</sup></b>   | Back Window (Slider)(Solar) (OE) .....  | <b>16.0x58.0</b> |
| <b>FB22478<sup>c</sup></b>   | Back Window (Heated)(Solar) (Stationary) .....  | <b>16.0x58.0</b> |

<sup>a</sup> Urethane,Dam,Primer - 2 Tubes  
<sup>b</sup> Fast-Cure Urethane/Dam/Primer - Quantity 2  
<sup>c</sup> Urethane,Dam,Primer - 1.5 Tubes

**Juke 4 Door Utility ..... 2011**

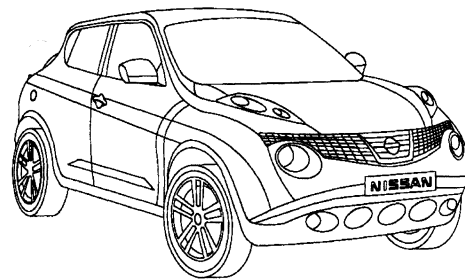

|                              |  |  |
|------------------------------|--|--|
| <b>FW03311<sup>a b</sup></b> | Windshield (Solar) (W/Third Visor Frit) .....      |  |
| <b>FD24806-07</b>            | Door F/R-L (Solar) .....                           |  |
| <b>FD24808-09</b>            | Door R/R-L (Solar) .....                           |  |
| <b>FB24810<sup>c</sup></b>   | Back Window (Heated)(1 Holes)(Solar) (W/Wiper) ... |  |

<sup>a</sup> Urethane,Dam,Primer - 2 Tubes  
<sup>b</sup> Fast-Cure Urethane/Dam/Primer - Quantity 2  
<sup>c</sup> Urethane,Dam,Primer - 1.5 Tubes

**Maxima 4 Door Sedan ..... 2009-2011**

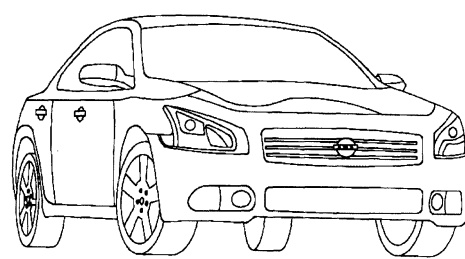

|                              |   |                  |
|------------------------------|---|------------------|
| <b>FW02955<sup>a b</sup></b> | Windshield (Solar) (W/Third Visor Frit) .....                   | <b>39.0x59.0</b> |
| <b>FD23931-32</b>            | Door F/R-L (Solar) .....  | <b>21.0x38.3</b> |
| <b>FD23933-34</b>            | Door R/R-L (Solar) .....  | <b>18.5x28.5</b> |
| <b>FV23935-36</b>            | Vent R/R-L (Solar) .....  | <b>9.0x10.0</b>  |
| <b>FB23948<sup>c</sup></b>   | Back Window (Ant)(Heated)(Solar) (W/Panoramic Glass Roof) ..... | <b>33.0x47.3</b> |
| <b>FB23937<sup>c</sup></b>   | Back Window (Ant)(Heated)(Solar) .....                          | <b>33.0x47.3</b> |

<sup>a</sup> Urethane,Dam,Primer - 2 Tubes  
<sup>b</sup> Fast-Cure Urethane/Dam/Primer - Quantity 2  
<sup>c</sup> Urethane,Dam,Primer - 1.5 Tubes

**Maxima 4 Door Sedan ..... 2006-2008**

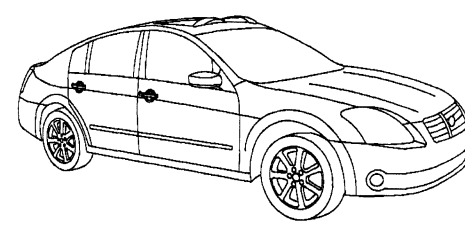

|                              |   |                  |
|------------------------------|---|------------------|
| <b>FW02410<sup>a b</sup></b> | Windshield (Solar) (W/Navigation) ..... | <b>38.5x58.7</b> |
| <b>FW02389<sup>a b</sup></b> | Windshield (Solar) .....                | <b>38.5x58.7</b> |
| <b>FD21928-29</b>            | Door F/R-L (Solar) .....                | <b>19.0x33.5</b> |
| <b>FD21930-31</b>            | Door R/R-L (Solar) .....                | <b>19.0x27.2</b> |
| <b>FV21932-33</b>            | Vent R/R-L (Solar) .....                | <b>9.0x11.5</b>  |
| <b>FB21934<sup>c</sup></b>   | Back Window (Ant)(Heated)(Solar) .....  | <b>24.3x48.0</b> |

<sup>a</sup> Urethane,Dam,Primer - 2 Tubes  
<sup>b</sup> Fast-Cure Urethane/Dam/Primer - Quantity 2  
<sup>c</sup> Urethane,Dam,Primer - 1.5 Tubes

**Micra 4 Door Hatchback (MEXICO Only)..... 2006-2008**

|                              |  |  |
|------------------------------|--|--|
| <b>FW02568<sup>a b</sup></b> | Windshield (Solar) (Mexico Only, Rain Sensor) .....          |  |
| <b>FW02567<sup>a b</sup></b> | Windshield (Solar) (Mexico Only) .....                       |  |
| <b>FD22653-54</b>            | Door F/R-L (Solar) (Mexico Only) .....                       |  |
| <b>FD22655-56</b>            | Door R/R-L (Solar) (Mexico Only) .....                       |  |
| <b>FV22657-58</b>            | Vent R/R-L (Solar) (Mexico Only) .....                       |  |
| <b>FB22660<sup>c</sup></b>   | Back Window (3 Holes)(Solar) (Mexico Only, W/ Spoiler) ..... |  |
| <b>FB22659<sup>c</sup></b>   | Back Window (1 Holes)(Solar) (Mexico Only) .....             |  |
| <sup>a</sup>                 | Urethane,Dam,Primer - 2 Tubes                                |  |
| <sup>b</sup>                 | Fast-Cure Urethane/Dam/Primer - Quantity 2                   |  |
| <sup>c</sup>                 | Urethane,Dam,Primer - 1.5 Tubes                              |  |

**Murano 4 Door Utility ..... 2009-2011**

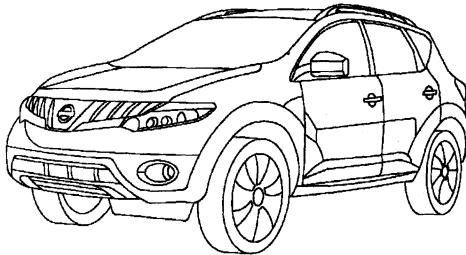

|                                |  |                  |
|--------------------------------|--|------------------|
| <b>FW02915<sup>a b c</sup></b> | Windshield (W/Third Visor Frit, Rain Sensor) ..... | <b>42.0x58.0</b> |
| <b>FW02914<sup>a b c</sup></b> | Windshield (W/Third Visor Frit) .....              | <b>42.0x58.0</b> |
| <b>FD23776-77</b>              | Door F/R-L (Solar) .....                           | <b>21.8x39.8</b> |
| <b>FD23778-79</b>              | Door R/R-L (Solar) .....                           | <b>20.0x30.5</b> |
| <b>FQ23780-81<sup>e</sup></b>  | Quarter R-L (Encap)(Solar) .....                   | <b>17.0x23.0</b> |
| <b>FB23782<sup>d</sup></b>     | Back Window (Heated)(1 Holes)(Solar) .....         | <b>20.0x50.5</b> |
| <sup>a</sup>                   | May Require Two Person Installation                |                  |
| <sup>b</sup>                   | Urethane,Dam,Primer - 2 Tubes                      |                  |
| <sup>c</sup>                   | Fast-Cure Urethane/Dam/Primer - Quantity 2         |                  |
| <sup>d</sup>                   | Urethane,Dam,Primer - 1.5 Tubes                    |                  |
| <sup>e</sup>                   | Urethane,Dam,Primer - 1 Tube                       |                  |

**Murano 4 Door Utility ..... 2006-2007**

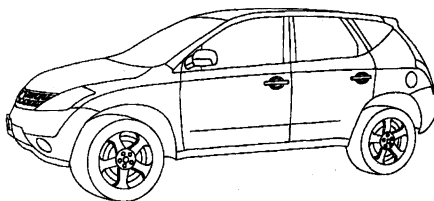

|                                |  |                  |
|--------------------------------|--|------------------|
| <b>FW02381<sup>a b c</sup></b> | Windshield (Solar) .....                   | <b>40.5x61.5</b> |
| <b>FD21908-09</b>              | Door F/R-L (Solar) .....                   | <b>20.0x37.5</b> |
| <b>FD21910-11</b>              | Door R/R-L (Solar) .....                   | <b>19.3x30.0</b> |
| <b>FQ21912-13<sup>e</sup></b>  | Quarter R-L (Encap)(Solar) .....           | <b>12.5x22.0</b> |
| <b>FB21914<sup>d</sup></b>     | Back Window (Heated)(1 Holes)(Solar) ..... | <b>20.5x53.5</b> |
| <sup>a</sup>                   | May Require Two Person Installation        |                  |
| <sup>b</sup>                   | Urethane,Dam,Primer - 2 Tubes              |                  |
| <sup>c</sup>                   | Fast-Cure Urethane/Dam/Primer - Quantity 2 |                  |
| <sup>d</sup>                   | Urethane,Dam,Primer - 1.5 Tubes            |                  |
| <sup>e</sup>                   | Urethane,Dam,Primer - 1 Tube               |                  |

**Pathfinder 4 Door Utility ..... 2006-2011**

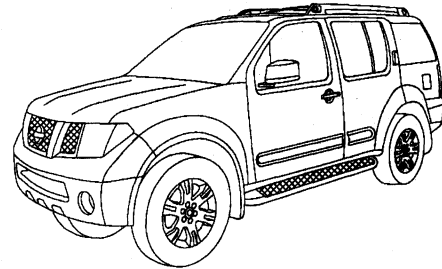

|                               |  |                  |
|-------------------------------|--|------------------|
| <b>FW02510<sup>a b</sup></b>  | Windshield (Solar) .....                         | <b>33.1x60.2</b> |
| <b>FD22456-57</b>             | Door F/R-L (Solar) .....                         | <b>23.5x32.6</b> |
| <b>FD22483-84</b>             | Door R/R-L (Solar) .....                         | <b>21.2x22.7</b> |
| <b>FQ22593<sup>c</sup></b>    | Quarter R (Ant)(Encap)(Solar) (W/Rear A/C) ..... | <b>18.0x34.5</b> |
| <b>FQ22487-88<sup>c</sup></b> | Quarter R-L (Ant)(Encap)(Solar) .....            | <b>18.0x34.5</b> |
| <b>FV22485-86</b>             | Vent R/R-L (Solar) .....                         | <b>11.5x19.5</b> |
| <b>FB22489</b>                | Back Window (Heated)(8 Holes)(Solar) .....       | <b>19.5x52.3</b> |
| <sup>a</sup>                  | Urethane,Dam,Primer - 2 Tubes                    |                  |
| <sup>b</sup>                  | Fast-Cure Urethane/Dam/Primer - Quantity 2       |                  |
| <sup>c</sup>                  | Urethane,Dam,Primer - 1 Tube                     |                  |

**Pickup 2 Door Standard Cab (MEXICO Only) ..... 2006-2011**

|                              |  |  |
|------------------------------|--|--|
| <b>FW03146<sup>a b</sup></b> | Windshield (Mexico Only) .....                       |  |
| <b>FD24417-18</b>            | Door F/R-L (Mexico Only) .....                       |  |
| <b>FB24422<sup>c</sup></b>   | Back Window (Heated) (Stationary, Mexico Only) ..... |  |
| <b>FB24421<sup>c</sup></b>   | Back Window (Stationary, Mexico Only) .....          |  |
| <sup>a</sup>                 | Urethane,Dam,Primer - 2 Tubes                        |  |
| <sup>b</sup>                 | Fast-Cure Urethane/Dam/Primer - Quantity 2           |  |
| <sup>c</sup>                 | Urethane,Dam,Primer - 1.5 Tubes                      |  |

**Pickup 4 Door Crew Cab (MEXICO Only) ..... 2006-2011**

|                              |  |  |
|------------------------------|--|--|
| <b>FW03146<sup>a b</sup></b> | Windshield (Mexico Only) .....                       |  |
| <b>FD24417-18</b>            | Door F/R-L (Mexico Only) .....                       |  |
| <b>FD24419-20</b>            | Door R/R-L (Mexico Only) .....                       |  |
| <b>FB24422<sup>c</sup></b>   | Back Window (Heated) (Stationary, Mexico Only) ..... |  |
| <b>FB24421<sup>c</sup></b>   | Back Window (Stationary, Mexico Only) .....          |  |
| <sup>a</sup>                 | Urethane,Dam,Primer - 2 Tubes                        |  |
| <sup>b</sup>                 | Fast-Cure Urethane/Dam/Primer - Quantity 2           |  |
| <sup>c</sup>                 | Urethane,Dam,Primer - 1.5 Tubes                      |  |

**Platina 4 Door Sedan (MEXICO Only) ..... 2006-2010**

|                              |  |                  |
|------------------------------|--|------------------|
| <b>FW02506<sup>a b</sup></b> | Windshield (Mexico Only) .....             |                  |
| <b>FD22425-26</b>            | Door F/R-L (Mexico Only) .....             |                  |
| <b>FD22427-28</b>            | Door R/R-L (Mexico Only) .....             |                  |
| <b>FV22429-30</b>            | Vent R/R-L (Mexico Only) .....             |                  |
| <b>FB22431<sup>c</sup></b>   | Back Window (Mexico Only) .....            | <b>25.5x46.8</b> |
| <sup>a</sup>                 | Urethane,Dam,Primer - 2 Tubes              |                  |
| <sup>b</sup>                 | Fast-Cure Urethane/Dam/Primer - Quantity 2 |                  |
| <sup>c</sup>                 | Urethane,Dam,Primer - 1.5 Tubes            |                  |

**Quest Mini Van ..... 2006-2010**

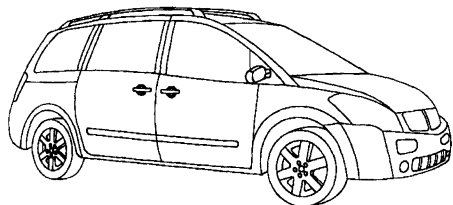

|   |                  |
|---|------------------|
| <b>FW02699<sup>a d e</sup></b> Windshield (Solar) (07-10) .....           | <b>45.5x63.8</b> |
| <b>FW02392<sup>a d e</sup></b> Windshield (Solar) (06) .....              | <b>45.5x63.8</b> |
| <b>FD21950-51</b> Door F/R-L (Solar) .....                                | <b>24.0x36.5</b> |
| <b>FD21952-53<sup>c</sup></b> Side R-L (Solar) (Sliding Cargo Door) ..... | <b>21.0x45.5</b> |
| <b>FQ22142-43</b> Quarter R-L (Ant)(Solar) (Manual) .....                 | <b>19.7x35.3</b> |
| <b>FQ21954-55</b> Quarter R-L (Ant)(Solar) (Power) .....                  | <b>19.7x35.3</b> |
| <b>FB21956<sup>b</sup></b> Back Window (Heated)(1 Holes)(Solar) .....     | <b>39.5x58.5</b> |

- <sup>a</sup> May Require Two Person Installation
- <sup>b</sup> Urethane,Dam,Primer - 2 Tubes
- <sup>c</sup> Urethane,Dam,Primer - 1.5 Tubes
- <sup>d</sup> Urethane,Dam,Primer - 2.5 Tubes
- <sup>e</sup> Fast-Cure Urethane/Dam/Primer - Quantity 2.5

**Rogue 4 Door Utility ..... 2008-2011**

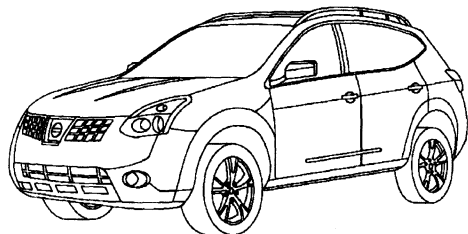

|  |                  |
|--|------------------|
| <b>FW02878<sup>a b</sup></b> Windshield (Solar) (W/Third Visor Frit) ..... | <b>39.0x55.0</b> |
| <b>FD23636-37</b> Door F/R-L .....   | <b>21.8x39.5</b> |
| <b>FD23638-39</b> Door R/R-L (Solar) .....                                 | <b>20.3x29.0</b> |
| <b>FQ23640-41<sup>d</sup></b> Quarter R-L (Encap)(Solar) .....             | <b>14.0x18.0</b> |
| <b>FB23642<sup>c</sup></b> Back Window (Heated)(1 Holes)(Solar) .....      | <b>22.0x50.3</b> |

- <sup>a</sup> Urethane,Dam,Primer - 2 Tubes
- <sup>b</sup> Fast-Cure Urethane/Dam/Primer - Quantity 2
- <sup>c</sup> Urethane,Dam,Primer - 1.5 Tubes
- <sup>d</sup> Urethane,Dam,Primer - 1 Tube

**Sentra 4 Door Sedan ..... 2007-2011**

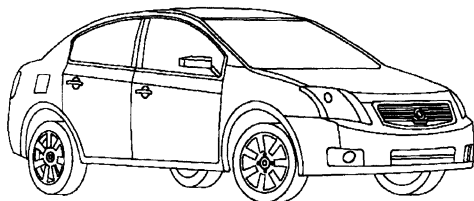

|  |                  |
|--|------------------|
| <b>FW02729<sup>a b</sup></b> Windshield (W/Third Visor Frit) ..... | <b>38.0x56.5</b> |
| <b>FD23371-72</b> Door F/R-L (Solar) .....                         | <b>22.5x38.5</b> |
| <b>FD23373-74</b> Door R/R-L (Solar) .....                         | <b>19.5x26.0</b> |
| <b>FV23375-76</b> Vent R/R-L (Solar) .....                         | <b>6.0x10.0</b>  |
| <b>FB23377<sup>c</sup></b> Back Window (Heated)(Solar) .....       | <b>26.8x48.0</b> |

- <sup>a</sup> Urethane,Dam,Primer - 2 Tubes
- <sup>b</sup> Fast-Cure Urethane/Dam/Primer - Quantity 2
- <sup>c</sup> Urethane,Dam,Primer - 1.5 Tubes

**Sentra 4 Door Sedan ..... 2006**

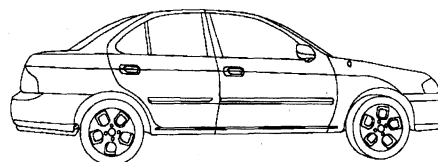

|   |                  |
|---|------------------|
| <b>FW02179<sup>a b</sup></b> Windshield .....         | <b>35.8x56.5</b> |
| <b>FD21029-30</b> Door F/R-L .....                    | <b>24.0x36.5</b> |
| <b>FD21031-32</b> Door R/R-L .....                    | <b>22.0x25.0</b> |
| <b>FV21033-34</b> Vent R/R-L .....                    | <b>10.5x12.0</b> |
| <b>FB21035<sup>c</sup></b> Back Window (Heated) ..... | <b>29.0x52.0</b> |

- <sup>a</sup> Urethane,Dam,Primer - 2 Tubes
- <sup>b</sup> Fast-Cure Urethane/Dam/Primer - Quantity 2
- <sup>c</sup> Urethane,Dam,Primer - 1.5 Tubes

**Tiida 4 Door Hatchback (MEXICO Only) ..... 2007-2010**

|   |                  |
|---|------------------|
| <b>FW03332<sup>a b</sup></b> Windshield (Solar) (W/Third Visor Frit, Export Only, Flex Fuel Option) (09-10) ..... | <b>38.1x52.7</b> |
| <b>FW02653<sup>a b</sup></b> Windshield (Solar) (W/Third Visor Frit) .....  | <b>38.1x52.7</b> |
| <b>FD23064-65</b> Door F/R-L (Solar) .....  | <b>22.5x38.3</b> |
| <b>FD23066-67</b> Door R/R-L (Solar) .....  | <b>20.5x24.0</b> |
| <b>FV23062-63<sup>d</sup></b> Vent F/R-L (Encap)(Solar) (Black Moulding) .....                                    | <b>10.8x15.8</b> |
| <b>FV23068-69</b> Vent R/R-L (Solar) .....  | <b>10.5x14.5</b> |
| <b>FB23070<sup>c</sup></b> Back Window (Heated)(1 Holes)(Solar) .....   | <b>20.3x51.6</b> |

- <sup>a</sup> Urethane,Dam,Primer - 2 Tubes
- <sup>b</sup> Fast-Cure Urethane/Dam/Primer - Quantity 2
- <sup>c</sup> Urethane,Dam,Primer - 1.5 Tubes
- <sup>d</sup> Urethane,Dam,Primer - 1 Tube

**Tiida 4 Door Sedan (MEXICO Only) ..... 2007-2010**

|   |                  |
|---|------------------|
| <b>FW03332<sup>a b</sup></b> Windshield (Solar) (W/Third Visor Frit, Export Only, Flex Fuel Option) (09-10) ..... | <b>38.1x52.7</b> |
| <b>FW02653<sup>a b</sup></b> Windshield (Solar) (W/Third Visor Frit) .....  | <b>38.1x52.7</b> |
| <b>FD23064-65</b> Door F/R-L (Solar) .....  | <b>22.5x38.3</b> |
| <b>FD23066-67</b> Door R/R-L (Solar) .....  | <b>20.5x24.0</b> |
| <b>FV23062-63<sup>d</sup></b> Vent F/R-L (Encap)(Solar) (Black Moulding) .....                                    | <b>10.8x15.8</b> |
| <b>FV23197-98</b> Vent R/R-L (Encap)(Solar) .....   | <b>9.1x15.8</b>  |
| <b>FB23199<sup>c</sup></b> Back Window (Heated)(Solar) .....  | <b>27.5x48.7</b> |

- <sup>a</sup> Urethane,Dam,Primer - 2 Tubes
- <sup>b</sup> Fast-Cure Urethane/Dam/Primer - Quantity 2
- <sup>c</sup> Urethane,Dam,Primer - 1.5 Tubes
- <sup>d</sup> Urethane,Dam,Primer - 1 Tube

**Titan 2 Door Extended Cab ..... 2006-2011**

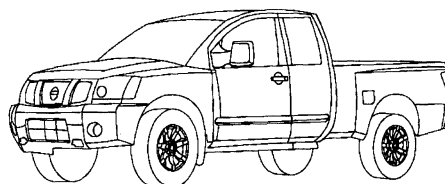

|  |                  |
|--|------------------|
| <b>FW02391<sup>a b c</sup></b> Windshield .....  | <b>34.8x63.9</b> |
| <b>FD21945-46</b> Door F/R-L .....   | <b>27.2x39.2</b> |
| <b>FQ21947-48<sup>e</sup></b> Quarter R-L (Solar) .....  | <b>18.5x21.5</b> |
| <b>FY95047<sup>d</sup></b> Back Window (Encap)(Slider)(Solar) (Black Frame, Aftermarket, Manual, 3 Panel Encapsulated) ..... | <b>16.5x60.0</b> |
| <b>FB22217<sup>d</sup></b> Back Window (Solar) (Stationary) .....  | <b>16.5x60.0</b> |
| <b>FB21949<sup>d</sup></b> Back Window (Slider)(Solar) (OE, Manual) .....  | <b>16.5x60.0</b> |

- <sup>a</sup> May Require Two Person Installation



**Titan (cont.)**

<sup>b</sup> Urethane,Dam,Primer - 2 Tubes  
<sup>c</sup> Fast-Cure Urethane/Dam/Primer - Quantity 2  
<sup>d</sup> Urethane,Dam,Primer - 1.5 Tubes  
<sup>e</sup> Urethane,Dam,Primer - 1 Tube

**Titan 4 Door Crew Cab..... 2006-2011**

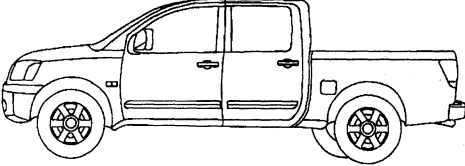

|  |                  |
|--|------------------|
| <b>FW02391<sup>a b c</sup></b> Windshield .....  | <b>34.8x63.9</b> |
| <b>FD21945-46</b> Door F/R-L .....   | <b>27.2x39.2</b> |
| <b>FD22215-16</b> Door R/R-L (Solar) .....   | <b>23.0x28.0</b> |
| <b>FY95048<sup>d</sup></b> Back Window (Encap)(Slider)(Solar) (Black Frame, Aftermarket, Power, 3 Panel Encapsulated) .....  | <b>16.5x60.0</b> |
| <b>FY95047<sup>d</sup></b> Back Window (Encap)(Slider)(Solar) (Black Frame, Aftermarket, Manual, 3 Panel Encapsulated) ..... | <b>16.5x60.0</b> |
| <b>FB23013<sup>e</sup></b> Back Window (Slider)(Solar) (OE, Power) .....   | <b>16.5x60.0</b> |
| <b>FB22217<sup>d</sup></b> Back Window (Solar) (Stationary) .....  | <b>16.5x60.0</b> |

<sup>a</sup> May Require Two Person Installation  
<sup>b</sup> Urethane,Dam,Primer - 2 Tubes  
<sup>c</sup> Fast-Cure Urethane/Dam/Primer - Quantity 2  
<sup>d</sup> Urethane,Dam,Primer - 1.5 Tubes  
<sup>e</sup> Foam Core Butyl Tape - Quantity 1.5

**Tsuru 4 Door Sedan (MEXICO Only)..... 2006-2011**

|   |                  |
|---|------------------|
| <b>FW00663<sup>a b</sup></b> Windshield .....               | <b>34.5x56.5</b> |
| <b>FD04324-25</b> Door F/R-L .....                          | <b>22.5x30.4</b> |
| <b>FD04326-27</b> Door R/R-L .....                          | <b>21.4x22.0</b> |
| <b>FV04328-29</b> Vent R/R-L .....                          | <b>13.5x15.5</b> |
| <b>FB05288<sup>a</sup></b> Back Window (Mexico Built) ..... | <b>28.3x54.0</b> |
| <b>FB04331<sup>a</sup></b> Back Window (Ant)(Heated) .....  | <b>28.3x54.0</b> |
| <b>FB04330<sup>a</sup></b> Back Window (Heated) .....       | <b>28.3x54.0</b> |

<sup>a</sup> Urethane,Dam,Primer - 2 Tubes  
<sup>b</sup> Fast-Cure Urethane/Dam/Primer - Quantity 2

**Urvan Van (MEXICO Only)..... 2006-2010**

|   |                  |
|---|------------------|
| <b>FW02446<sup>a b</sup></b> Windshield (W/Third Visor Frit, Mexico Only) ..... | <b>31.4x59.1</b> |
| <b>FD21790</b> Door F/R (Sliding Cargo Door, Mexico Only) .....                 |                  |
| <b>FD21788-89</b> Door F/R-L (Mexico Only) .....                                | <b>22.0x33.8</b> |
| <b>FD21791</b> Door R/R (Sliding Cargo Door, Mexico Only) .....                 |                  |
| <b>FS21792</b> Side F/L (Mexico Only) .....                                     |                  |
| <b>FS21793</b> Side R/L (Mexico Only) .....                                     |                  |
| <b>FQ21794-95</b> Quarter F/R-L (Mexico Only) .....                             |                  |
| <b>FQ21796-97</b> Quarter R/R-L (Mexico Only) .....                             |                  |
| <b>FB21798<sup>c</sup></b> Back Window (Mexico Only) .....                      | <b>24.0x54.0</b> |

<sup>a</sup> Urethane,Dam,Primer - 2 Tubes  
<sup>b</sup> Fast-Cure Urethane/Dam/Primer - Quantity 2  
<sup>c</sup> Urethane,Dam,Primer - 1.5 Tubes

**Versa 4 Door Hatchback..... 2007-2011**

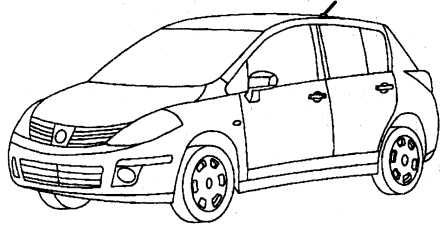

|  |                  |
|--|------------------|
| <b>FW02653<sup>a b</sup></b> Windshield (Solar) (W/Third Visor Frit) .....     | <b>38.1x52.7</b> |
| <b>FD23064-65</b> Door F/R-L (Solar) .....                                     | <b>22.5x38.3</b> |
| <b>FD23066-67</b> Door R/R-L (Solar) .....                                     | <b>20.5x24.0</b> |
| <b>FV23062-63<sup>d</sup></b> Vent F/R-L (Encap)(Solar) (Black Moulding) ..... | <b>10.8x15.8</b> |
| <b>FV23068-69</b> Vent R/R-L (Solar) .....                                     | <b>10.5x14.5</b> |
| <b>FB23070<sup>c</sup></b> Back Window (Heated)(1 Holes)(Solar) .....          | <b>20.3x51.6</b> |

<sup>a</sup> Urethane,Dam,Primer - 2 Tubes  
<sup>b</sup> Fast-Cure Urethane/Dam/Primer - Quantity 2  
<sup>c</sup> Urethane,Dam,Primer - 1.5 Tubes  
<sup>d</sup> Urethane,Dam,Primer - 1 Tube

**Versa 4 Door Sedan ..... 2007-2011**

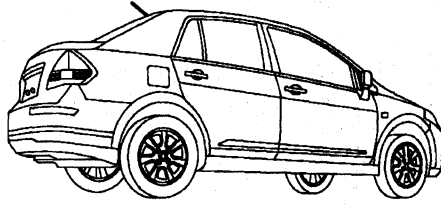

|   |                  |
|---|------------------|
| <b>FW02653<sup>a b</sup></b> Windshield (Solar) (W/Third Visor Frit) .....            | <b>38.1x52.7</b> |
| <b>FD23064-65</b> Door F/R-L (Solar) .....  | <b>22.5x38.3</b> |
| <b>FD23066-67</b> Door R/R-L (Solar) .....  | <b>20.5x24.0</b> |
| <b>FV24138-39<sup>d</sup></b> Vent F/R-L (Encap)(Solar) (Black/Chrome Moulding) ..... | <b>9.5x 9.5</b>  |
| <b>FV23197-98</b> Vent R/R-L (Encap)(Solar) .....                                     | <b>9.1x15.8</b>  |
| <b>FB23199<sup>c</sup></b> Back Window (Heated)(Solar) .....                          | <b>27.5x48.7</b> |

<sup>a</sup> Urethane,Dam,Primer - 2 Tubes  
<sup>b</sup> Fast-Cure Urethane/Dam/Primer - Quantity 2  
<sup>c</sup> Urethane,Dam,Primer - 1.5 Tubes  
<sup>d</sup> Urethane,Dam,Primer - 1 Tube

**X-Trail 4 Door Utility (MEXICO Only)..... 2008-2010**

|   |  |
|---|--|
| <b>FW02933<sup>a b</sup></b> Windshield (Mexico Only) .....                         |  |
| <b>FD23806-07</b> Door F/R-L (Mexico Only) .....                                    |  |
| <b>FD23808-09</b> Door R/R-L (Mexico Only) .....                                    |  |
| <b>FQ23810-11<sup>c</sup></b> Quarter R-L (Encap) (Mexico Only) .....               |  |
| <b>FB23812<sup>c</sup></b> Back Window (Heated)(1 Holes)(Solar) (Mexico Only) ..... |  |

<sup>a</sup> Urethane,Dam,Primer - 2 Tubes  
<sup>b</sup> Fast-Cure Urethane/Dam/Primer - Quantity 2  
<sup>c</sup> Urethane,Dam,Primer - 1.5 Tubes

**X-Trail 4 Door Utility ..... 2006-2007**

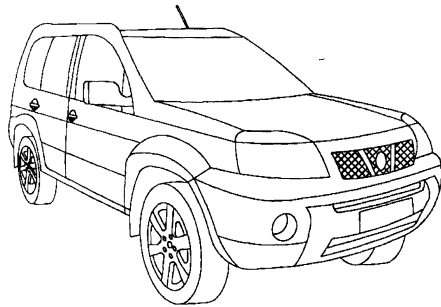

|   |                  |
|---|------------------|
| <b>FW02329<sup>a</sup></b> Windshield (Solar) .....                           | <b>39.0x57.0</b> |
| <b>FD21742-43</b> Door F/R-L (Solar) .....                                    | <b>21.3x37.5</b> |
| <b>FD21744-45</b> Door R/R-L (Solar) .....                                    | <b>22.0x28.5</b> |
| <b>FQ21746-47<sup>d</sup></b> Quarter R-L (Encap)(Solar) .....                | <b>18.0x21.3</b> |
| <b>FB21748<sup>c</sup></b> Back Window (Heated)(1 Holes)(Solar) (W/Wiper) ... | <b>22.5x48.0</b> |

- <sup>a</sup> Urethane,Dam,Primer - 2 Tubes
- <sup>b</sup> Fast-Cure Urethane/Dam/Primer - Quantity 2
- <sup>c</sup> Urethane,Dam,Primer - 1.5 Tubes
- <sup>d</sup> Urethane,Dam,Primer - 1 Tube

**XTerra 4 Door Utility ..... 2006-2011**

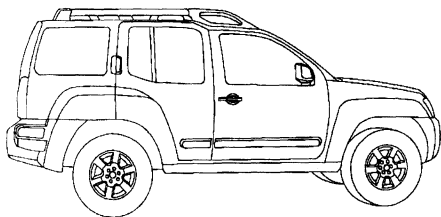

|  |                  |
|--|------------------|
| <b>FW02510<sup>a</sup></b> Windshield (Solar) .....          | <b>33.1x60.2</b> |
| <b>FD22456-57</b> Door F/R-L (Solar) .....                   | <b>23.5x32.6</b> |
| <b>FD22490-91</b> Door R/R-L (Solar) .....                   | <b>19.4x25.0</b> |
| <b>FQ22494-95<sup>d</sup></b> Quarter R-L (Solar) .....      | <b>19.3x27.0</b> |
| <b>FV22492-93</b> Vent R/R-L (Solar) .....                   | <b>8.7x22.3</b>  |
| <b>FB22496<sup>c</sup></b> Back Window (Heated)(Solar) ..... | <b>20.4x50.7</b> |

- <sup>a</sup> Urethane,Dam,Primer - 2 Tubes
- <sup>b</sup> Fast-Cure Urethane/Dam/Primer - Quantity 2
- <sup>c</sup> Urethane,Dam,Primer - 1.5 Tubes
- <sup>d</sup> Urethane,Dam,Primer - 1 Tube

**Peugeot**

**206 2 Door Convertible (MEXICO Only) ..... 2006-2008**

|   |  |
|---|--|
| <b>FW02671<sup>a</sup></b> Windshield (Solar) (Mexico Only) ..... |  |
| <b>FD23113-14</b> Door F/R-L (Solar) (Mexico Only) .....          |  |
| <b>FQ23115-16</b> Quarter R-L (Solar) (Mexico Only) .....         |  |
| <b>FB23117</b> Back Window (Heated)(Solar) (Mexico Only) .....    |  |

- <sup>a</sup> Urethane,Dam,Primer - 2 Tubes
- <sup>b</sup> Fast-Cure Urethane/Dam/Primer - Quantity 2

**206 2 Door Hatchback (MEXICO Only) ..... 2006-2008**

|   |                  |
|---|------------------|
| <b>FW02844<sup>a</sup></b> Windshield (Encap)(Solar) (W/Third Visor Frit, Mexico Only, Rain Sensor) ..... | <b>38.0x54.0</b> |
| <b>FD21282-83</b> Door F/R-L (2 Holes) (Mexico Only) .....  | <b>21.0x38.5</b> |
| <b>FQ21284-85</b> Quarter R-L (3 Holes) (Mexico Only, Movable) .....                                      | <b>17.8x22.0</b> |
| <b>FB21290<sup>c</sup></b> Back Window (Heated)(Solar) (Mexico Only) .....                                | <b>22.0x51.0</b> |

- <sup>a</sup> Urethane,Dam,Primer - 2 Tubes

**206 (cont.)**

- <sup>b</sup> Fast-Cure Urethane/Dam/Primer - Quantity 2
- <sup>c</sup> Urethane,Dam,Primer - 1.5 Tubes
- <sup>d</sup> Rain Sensor Kit

**206 4 Door Hatchback (MEXICO Only) ..... 2006-2008**

|   |                  |
|---|------------------|
| <b>FW02844<sup>a</sup></b> Windshield (Encap)(Solar) (W/Third Visor Frit, Mexico Only, Rain Sensor) ..... | <b>38.0x54.0</b> |
| <b>FD21286-87</b> Door F/R-L (2 Holes)(Solar) (Mexico Only) .....   | <b>20.0x31.0</b> |
| <b>FD21288-89</b> Door R/R-L (1 Holes)(Solar) (Mexico Only) .....   | <b>19.0x25.3</b> |
| <b>FB21290<sup>c</sup></b> Back Window (Heated)(Solar) (Mexico Only) .....                                | <b>22.0x51.0</b> |

- <sup>a</sup> Urethane,Dam,Primer - 2 Tubes
- <sup>b</sup> Fast-Cure Urethane/Dam/Primer - Quantity 2
- <sup>c</sup> Urethane,Dam,Primer - 1.5 Tubes
- <sup>d</sup> Rain Sensor Kit

**206 4 Door Station Wagon (MEXICO Only) ..... 2006-2008**

|   |                  |
|---|------------------|
| <b>FW02844<sup>a</sup></b> Windshield (Encap)(Solar) (W/Third Visor Frit, Mexico Only, Rain Sensor) ..... | <b>38.0x54.0</b> |
| <b>FD21286-87</b> Door F/R-L (2 Holes)(Solar) (Mexico Only) .....   | <b>20.0x31.0</b> |
| <b>FD23118-19</b> Door R/R-L (Solar) (Mexico Only) .....  |                  |
| <b>FQ23120-21</b> Quarter R-L (Solar) (Mexico Only) .....   |                  |
| <b>FB23122</b> Back Window (Heated)(Solar) (Mexico Only) .....  |                  |

- <sup>a</sup> Urethane,Dam,Primer - 2 Tubes
- <sup>b</sup> Fast-Cure Urethane/Dam/Primer - Quantity 2
- <sup>c</sup> Rain Sensor Kit

**207 2 Door Convertible (MEXICO Only) ..... 2008-2010**

|   |  |
|---|--|
| <b>FW03019<sup>a</sup></b> Windshield (Ant)(Solar) (W/Third Visor Frit, Mexico Only, Rain Sensor) ..... |  |
| <b>FW03018<sup>a</sup></b> Windshield (Solar) (W/Third Visor Frit, Mexico Only, Rain Sensor) .....      |  |
| <b>FW03017<sup>a</sup></b> Windshield (Ant)(Solar) (W/Third Visor Frit, Mexico Only) .....              |  |
| <b>FW03016<sup>a</sup></b> Windshield (Solar) (W/Third Visor Frit, Mexico Only) .....                   |  |

|   |  |
|---|--|
| <b>FD24072-73</b> Door F/R-L (Solar) (Mexico Only) .....                    |  |
| <b>FQ24074-75</b> Quarter R-L (Encap)(Solar) (Mexico Only) .....            |  |
| <b>FV24070-71<sup>c</sup></b> Vent F/R-L (Encap)(Solar) (Mexico Only) ..... |  |
| <b>FB24076<sup>c</sup></b> Back Window (Heated)(Solar) (Mexico Only) .....  |  |

- <sup>a</sup> Urethane,Dam,Primer - 2 Tubes
- <sup>b</sup> Fast-Cure Urethane/Dam/Primer - Quantity 2
- <sup>c</sup> Urethane,Dam,Primer - 1.5 Tubes
- <sup>d</sup> Rain Sensor Kit

**207 2 Door Hatchback (MEXICO Only) ..... 2007-2010**

|   |                  |
|---|------------------|
| <b>FW02951<sup>a</sup></b> Windshield (Encap)(Solar) (Mexico Only, Solar Coated, Rain Sensor) ..... |                  |
| <b>FW02950<sup>a</sup></b> Windshield (Encap)(Solar) (Mexico Only, Solar Coated) .....              | <b>38.0x54.0</b> |

|   |  |
|---|--|
| <b>FW02949<sup>a</sup></b> Windshield (Encap)(Solar) (Mexico Only) .....      |  |
| <b>FD23894-95</b> Door F/R-L (Solar) (Mexico Only) .....                      |  |
| <b>FQ23896-97<sup>c</sup></b> Quarter R-L (Solar) (Mexico Only) .....         |  |
| <b>FV23892-93</b> Vent F/R-L (Encap)(Solar) (Mexico Only) .....               |  |
| <b>FB23899<sup>c</sup></b> Back Window (Ant)(Heated)(Solar) (Mexico Only) ... |  |
| <b>FB23898<sup>c</sup></b> Back Window (Heated)(Solar) (Mexico Only) .....    |  |

- <sup>a</sup> Urethane,Dam,Primer - 2 Tubes
- <sup>b</sup> Fast-Cure Urethane/Dam/Primer - Quantity 2
- <sup>c</sup> Urethane,Dam,Primer - 1.5 Tubes

|  |  |
|--|--|
| <p><b>307 2 Door Convertible (MEXICO Only) ..... 2006-2009</b></p> <p><b>FW02686<sup>a b</sup></b> Windshield (Solar) (Mexico Only, Rain Sensor) .....</p> <p><b>FW02672<sup>a b</sup></b> Windshield (Solar) (Mexico Only) .....</p> <p><b>FD23123-24</b> Door F/R-L (Solar) (Mexico Only) .....</p> <p><b>FQ23125-26</b> Quarter R-L (Solar) (Mexico Only) .....</p> <p><b>FB23127</b> Back Window (Heated)(Solar) (Mexico Only) .....</p> <p><sup>a</sup> Urethane,Dam,Primer - 2 Tubes<br/><sup>b</sup> Fast-Cure Urethane/Dam/Primer - Quantity 2</p>   | <p><b>308 (cont.)</b></p> <p><b>FD24099-00</b> Door F/R-L (Solar) (Laminated, Mexico Only) .....</p> <p><b>FD24097-98</b> Door F/R-L (Solar) (Mexico Only) .....</p> <p><b>FD24103-04</b> Door R/R-L (Solar) (Laminated, Mexico Only) .....</p> <p><b>FD24101-02</b> Door R/R-L (Solar) (Mexico Only) .....</p> <p><b>FV24095-96<sup>c</sup></b> Vent F/R-L (Encap)(Solar) (Mexico Only) .....</p> <p><b>FB24106<sup>c</sup></b> Back Window (Ant)(Heated)(Solar) (Mexico Only) ...</p> <p><b>FB24105<sup>c</sup></b> Back Window (Heated)(Solar) (Mexico Only) .....</p> <p><sup>a</sup> Urethane,Dam,Primer - 2 Tubes<br/><sup>b</sup> Fast-Cure Urethane/Dam/Primer - Quantity 2<br/><sup>c</sup> Urethane,Dam,Primer - 1.5 Tubes</p>   |
| <p><b>307 2 Door Hatchback (MEXICO Only)..... 2006-2008</b></p> <p><b>FW02687<sup>a b</sup></b> Windshield (Solar) (Mexico Only, Rain Sensor) .....</p> <p><b>FW02673<sup>a b</sup></b> Windshield (Mexico Only) .....</p> <p><b>FD23308-09</b> Door F/R-L (Solar) (Mexico Only) .....</p> <p><b>FQ23132-33</b> Quarter R-L (Solar) (Mexico Only) .....</p> <p><b>FV23128-29</b> Vent F/R-L (Solar) (Mexico Only) .....</p> <p><b>FB23134<sup>c</sup></b> Back Window (Heated)(Solar) (Mexico Only) .....</p> <p><sup>a</sup> Urethane,Dam,Primer - 2 Tubes<br/><sup>b</sup> Fast-Cure Urethane/Dam/Primer - Quantity 2<br/><sup>c</sup> Urethane,Dam,Primer - 1.5 Tubes</p> | <p><b>407 4 Door Sedan (MEXICO Only)..... 2006-2009</b></p> <p><b>FW02509<sup>a b</sup></b> Windshield (Encap)(Solar) .....</p> <p><b>FD23200-01</b> Door F/R-L (Solar) (Acoustic Interlayer) (07-09) ..... <b>21.5x35.0</b></p> <p><b>FD22443-44</b> Door F/R-L (Solar) (Laminated) (06) ..... <b>21.5x35.0</b></p> <p><b>FD22441-42</b> Door F/R-L (2 Holes)(Solar) ..... <b>20.3x38.5</b></p> <p><b>FD23202-03</b> Door R/R-L (Solar) (Acoustic Interlayer) (07-09) ..... <b>19.0x31.8</b></p> <p><b>FD22447-48</b> Door R/R-L (Solar) (Laminated) (06) ..... <b>19.0x31.8</b></p> <p><b>FD22445-46</b> Door R/R-L (2 Holes)(Solar) ..... <b>20.8x31.6</b></p> <p><b>FB22449<sup>c</sup></b> Back Window (Heated)(Solar) .....</p> <p><sup>a</sup> Urethane,Dam,Primer - 2 Tubes<br/><sup>b</sup> Fast-Cure Urethane/Dam/Primer - Quantity 2<br/><sup>c</sup> Urethane,Dam,Primer - 1.5 Tubes</p> |
| <p><b>307 4 Door Hatchback (MEXICO Only)..... 2006-2009</b></p> <p><b>FW02687<sup>a b</sup></b> Windshield (Solar) (Mexico Only, Rain Sensor) .....</p> <p><b>FW02673<sup>a b</sup></b> Windshield (Mexico Only) .....</p> <p><b>FD23130-31</b> Door F/R-L (Solar) (Mexico Only) .....</p> <p><b>FD23135-36</b> Door R/R-L (Solar) (Mexico Only) .....</p> <p><b>FV23128-29</b> Vent F/R-L (Solar) (Mexico Only) .....</p> <p><b>FB23134<sup>c</sup></b> Back Window (Heated)(Solar) (Mexico Only) .....</p> <p><sup>a</sup> Urethane,Dam,Primer - 2 Tubes<br/><sup>b</sup> Fast-Cure Urethane/Dam/Primer - Quantity 2<br/><sup>c</sup> Urethane,Dam,Primer - 1.5 Tubes</p>  | <p><b>607 4 Door Sedan (MEXICO Only)..... 2006-2008</b></p> <p><b>FW02895<sup>a b</sup></b> Windshield (Solar) (Mexico Only) .....</p> <p><b>FD23663-64</b> Door F/R-L (Solar) (Mexico Only) .....</p> <p><b>FD23665-66</b> Door R/R-L (Solar) (Mexico Only) .....</p> <p><b>FV23667-68</b> Vent R/R-L (Solar) (Mexico Only) .....</p> <p><b>FB23669<sup>c</sup></b> Back Window (Heated)(Solar) (Mexico Only) .....</p> <p><sup>a</sup> Urethane,Dam,Primer - 2 Tubes<br/><sup>b</sup> Fast-Cure Urethane/Dam/Primer - Quantity 2<br/><sup>c</sup> Urethane,Dam,Primer - 1.5 Tubes</p>  |
| <p><b>307 4 Door Sedan (MEXICO Only) ..... 2007-2009</b></p> <p><b>FW02673<sup>a b</sup></b> Windshield (Mexico Only) .....</p> <p><b>FD23130-31</b> Door F/R-L (Solar) (Mexico Only) .....</p> <p><b>FD23135-36</b> Door R/R-L (Solar) (Mexico Only) .....</p> <p><b>FQ23655-56<sup>c</sup></b> Quarter R-L (Solar) (Mexico Only) .....</p> <p><b>FV23128-29</b> Vent F/R-L (Solar) (Mexico Only) .....</p> <p><b>FB23657<sup>c</sup></b> Back Window (Heated)(Solar) (Mexico Only) .....</p> <p><sup>a</sup> Urethane,Dam,Primer - 2 Tubes<br/><sup>b</sup> Fast-Cure Urethane/Dam/Primer - Quantity 2<br/><sup>c</sup> Urethane,Dam,Primer - 1.5 Tubes</p>                | <p><b>Expert Cargo Van (MEXICO Only)..... 2009-2010</b></p> <p><b>FW03035<sup>a b</sup></b> Windshield (Encap)(Solar) (Mexico Only, Solar Coated, Rain Sensor) .....</p> <p><b>FW03034<sup>a b</sup></b> Windshield (Encap)(Solar) (Mexico Only, Solar Coated) .....</p> <p><b>FW03033<sup>a b</sup></b> Windshield (Encap)(Solar) (Mexico Only, Rain Sensor) .....</p> <p><b>FW03032<sup>a b</sup></b> Windshield (Encap)(Solar) (Mexico Only) .....</p> <p><b>FD24107-08</b> Door F/R-L (Solar) (Mexico Only) .....</p> <p><b>FB24113<sup>c</sup></b> Back Window (Heated)(Solar) (Mexico Only) .....</p> <p><sup>a</sup> Urethane,Dam,Primer - 2 Tubes<br/><sup>b</sup> Fast-Cure Urethane/Dam/Primer - Quantity 2<br/><sup>c</sup> Urethane,Dam,Primer - 1.5 Tubes</p>   |
| <p><b>307 4 Door Station Wagon (MEXICO Only) ..... 2006-2009</b></p> <p><b>FW02687<sup>a b</sup></b> Windshield (Solar) (Mexico Only, Rain Sensor) .....</p> <p><b>FW02673<sup>a b</sup></b> Windshield (Mexico Only) .....</p> <p><b>FD23130-31</b> Door F/R-L (Solar) (Mexico Only) .....</p> <p><b>FD23137-38</b> Door R/R-L (Solar) (Mexico Only) .....</p> <p><b>FQ23139-40</b> Quarter R-L (Solar) (Mexico Only) .....</p> <p><b>FB23141</b> Back Window (Heated)(Solar) (Mexico Only) .....</p> <p><sup>a</sup> Urethane,Dam,Primer - 2 Tubes<br/><sup>b</sup> Fast-Cure Urethane/Dam/Primer - Quantity 2</p>   | <p><b>Expert Van (MEXICO Only) ..... 2009-2010</b></p> <p><b>FW03035<sup>a b</sup></b> Windshield (Encap)(Solar) (Mexico Only, Solar Coated, Rain Sensor) .....</p> <p><b>FW03034<sup>a b</sup></b> Windshield (Encap)(Solar) (Mexico Only, Solar Coated) .....</p> <p><b>FW03033<sup>a b</sup></b> Windshield (Encap)(Solar) (Mexico Only, Rain Sensor) .....</p> <p><b>FW03032<sup>a b</sup></b> Windshield (Encap)(Solar) (Mexico Only) .....</p> <p><b>FD24107-08</b> Door F/R-L (Solar) (Mexico Only) .....</p> <p><b>FD24109-10</b> Door R/R-L (Encap)(Solar) (Mexico Only) .....</p> <p><b>FQ24111-12<sup>c</sup></b> Quarter R-L (Solar) (Mexico Only) .....</p> <p><b>FB24113<sup>c</sup></b> Back Window (Heated)(Solar) (Mexico Only) .....</p> <p><sup>a</sup> Urethane,Dam,Primer - 2 Tubes<br/><sup>b</sup> Fast-Cure Urethane/Dam/Primer - Quantity 2</p>                             |
| <p><b>308 4 Door Hatchback (MEXICO Only)..... 2009-2010</b></p> <p><b>FW03030<sup>a b</sup></b> Windshield (Solar) (Mexico Only, Acoustic Interlayer, Solar Coated, Rain Sensor) .....</p> <p><b>FW03029<sup>a b</sup></b> Windshield (Solar) (Mexico Only, Acoustic Interlayer, Rain Sensor) .....</p> <p><b>FW03028<sup>a b</sup></b> Windshield (Solar) (Mexico Only, Acoustic Interlayer)</p>  | <p><b>FW03035<sup>a b</sup></b> Windshield (Encap)(Solar) (Mexico Only, Solar Coated, Rain Sensor) .....</p> <p><b>FW03034<sup>a b</sup></b> Windshield (Encap)(Solar) (Mexico Only, Solar Coated) .....</p> <p><b>FW03033<sup>a b</sup></b> Windshield (Encap)(Solar) (Mexico Only, Rain Sensor) .....</p> <p><b>FW03032<sup>a b</sup></b> Windshield (Encap)(Solar) (Mexico Only) .....</p> <p><b>FD24107-08</b> Door F/R-L (Solar) (Mexico Only) .....</p> <p><b>FD24109-10</b> Door R/R-L (Encap)(Solar) (Mexico Only) .....</p> <p><b>FQ24111-12<sup>c</sup></b> Quarter R-L (Solar) (Mexico Only) .....</p> <p><b>FB24113<sup>c</sup></b> Back Window (Heated)(Solar) (Mexico Only) .....</p> <p><sup>a</sup> Urethane,Dam,Primer - 2 Tubes<br/><sup>b</sup> Fast-Cure Urethane/Dam/Primer - Quantity 2</p>  |

| <i>Expert</i>   | <i>(cont.)</i> |
|---|----------------|
| <sup>c</sup> Urethane,Dam,Primer - 1.5 Tubes  |                |
| <b>Grand Raid Mini Van (MEXICO Only) ..... 2007-2010</b>  |                |
| <b>FW02715<sup>a b</sup></b> Windshield (Mexico Only) .....   |                |
| <b>FD23300-01</b> Door F/R-L (Mexico Only) .....  |                |
| <b>FD23658-59</b> Door R/R-L (3 Holes) (Mexico Only) .....  |                |
| <b>FQ23660-61</b> Quarter R-L (3 Holes) (Mexico Only) .....   |                |
| <b>FB23302-03</b> Back Window R-L (Mexico Only) .....   |                |
| <b>FB23662<sup>c</sup></b> Back Window (Heated)(1 Holes) (Mexico Only, One-Piece) .....   |                |
| <sup>a</sup> Urethane,Dam,Primer - 2 Tubes<br><sup>b</sup> Fast-Cure Urethane/Dam/Primer - Quantity 2<br><sup>c</sup> Urethane,Dam,Primer - 1.5 Tubes |                |

| <i>Manager</i>  | Cargo Van (MEXICO Only) ..... 2009-2010 |
|---|---|
| <b>FW03031<sup>a b</sup></b> Windshield (Encap)(Solar) (Mexico Only, Solar Coated) .....  |   |
| <b>FW02929<sup>a b</sup></b> Windshield (Encap)(Solar) (Mexico Only, Solar Coated, Rain Sensor) .....   |   |
| <b>FW02928<sup>a b</sup></b> Windshield (Encap)(Solar) (Mexico Only, Rain Sensor) .....   |   |
| <b>FW02927<sup>a b</sup></b> Windshield (Encap)(Solar) (Mexico Only) .....  |   |
| <b>FD23797-98</b> Door F/R-L (Solar) (Mexico Only) .....  |   |
| <b>FD24128<sup>c</sup></b> Door R/R-L (Solar) (Mexico Only) .....   |   |
| <b>FQ24129-30<sup>c</sup></b> Quarter R-L (Solar) (Mexico Only) .....   |   |
| <b>FV23795-96</b> Vent F/R-L (Solar) (Mexico Only) .....  |   |
| <b>FB24131-32<sup>c</sup></b> Back Window R-L (Heated)(Solar) (Mexico Only) .....   |   |
| <sup>a</sup> Urethane,Dam,Primer - 2 Tubes<br><sup>b</sup> Fast-Cure Urethane/Dam/Primer - Quantity 2<br><sup>c</sup> Urethane,Dam,Primer - 1.5 Tubes |   |

| <i>Partner</i>  | Mini Van (MEXICO Only) ..... 2006-2010 |
|---|--|
| <b>FW02715<sup>a b</sup></b> Windshield (Mexico Only) .....   |  |
| <b>FD23300-01</b> Door F/R-L (Mexico Only) .....  |  |
| <b>FB23302-03</b> Back Window R-L (Mexico Only) .....   |  |
| <sup>a</sup> Urethane,Dam,Primer - 2 Tubes<br><sup>b</sup> Fast-Cure Urethane/Dam/Primer - Quantity 2 |  |

**Pontiac**

**Aztek 4 Door Utility ..... 2006**

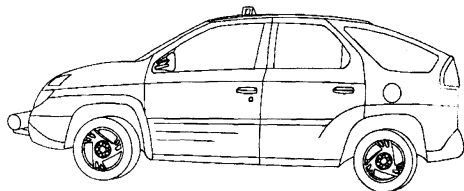

|  |           |
|--|-----------|
| <b>DW01826<sup>a b f g</sup></b> Windshield (Ant)(Solar) (W/AM/FM Antenna, Aftermarket) .....                      | 47.3x63.3 |
| <b>DW01405<sup>a c f g</sup></b> Windshield (Ant)(HUD)(Solar) (W/AM/FM Antenna, Solar Coated, W/GPS Antenna) ..... | 47.3x63.3 |
| <b>DW01404<sup>a c f g</sup></b> Windshield (Ant)(Solar) (W/AM/FM Antenna, Solar Coated, W/GPS Antenna) .....      | 47.3x63.3 |
| <b>DW01403<sup>a c f g</sup></b> Windshield (Ant)(HUD)(Solar) (W/AM/FM Antenna, Solar Coated) .....                | 47.3x63.3 |
| <b>DW01402<sup>a c f g</sup></b> Windshield (Ant)(Solar) (W/AM/FM Antenna, Solar Coated) .....                     | 47.3x63.3 |

| <i>Aztek</i>   | <i>(cont.)</i> |
|--|----------------|
| <b>DD09801-02</b> Door F/R-L (Solar) .....   | 24.5x39.0      |
| <b>DD09803-04</b> Door R/R-L (Solar) .....   | 23.0x28.5      |
| <b>DQ09805-06<sup>e</sup></b> Quarter R-L (Encap)(Solar) .....   | 13.5x36.5      |
| <b>DB10124<sup>d</sup></b> Back Window (Encap)(Solar) (W/Spoiler) .....  | 47.0x50.0      |
| <sup>a</sup> May Require Two Person Installation<br><sup>b</sup> Not On Production Vehicles<br><sup>c</sup> On Production Vehicles<br><sup>d</sup> Urethane,Dam,Primer - 2 Tubes<br><sup>e</sup> Urethane,Dam,Primer - 1 Tube<br><sup>f</sup> Urethane,Dam,Primer - 2.5 Tubes<br><sup>g</sup> Fast-Cure Urethane/Dam/Primer - Quantity 2.5 |                |

**G3 4 Door Hatchback (MEXICO Only)..... 2009**

|  |           |
|--|-----------|
| <b>DW01695<sup>a b</sup></b> Windshield .....  | 36.2x53.8 |
| <b>DD10639-40</b> Door F/R-L .....   | 21.8x38.0 |
| <b>DD11780-81</b> Door R/R-L .....   | 19.0x24.5 |
| <b>DR10866</b> Roof (Solar) .....  | 15.0x31.5 |
| <b>DQ10646-47<sup>d</sup></b> Quarter R-L .....  | 9.0x14.5  |
| <b>DB11706<sup>c</sup></b> Back Window (Heated) (W/Wiper) .....  | 18.5x52.5 |
| <sup>a</sup> Urethane,Dam,Primer - 2 Tubes<br><sup>b</sup> Fast-Cure Urethane/Dam/Primer - Quantity 2<br><sup>c</sup> Urethane,Dam,Primer - 1.5 Tubes<br><sup>d</sup> Urethane,Dam,Primer - 1 Tube |           |

**G3 4 Door Sedan ..... 2009**

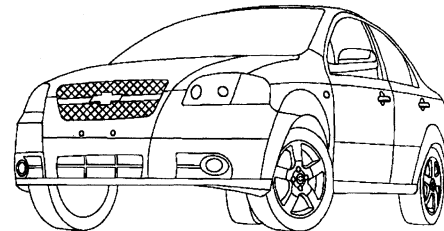

|   |           |
|---|-----------|
| <b>DW01695<sup>a b</sup></b> Windshield .....   | 36.2x53.8 |
| <b>DD10639-40</b> Door F/R-L .....  | 21.8x38.0 |
| <b>DD11286-87</b> Door R/R-L (2 Holes) .....  | 21.0x28.0 |
| <b>DB11288<sup>c</sup></b> Back Window (Ant)(Heated)(Solar) .....   | 27.0x47.5 |
| <sup>a</sup> Urethane,Dam,Primer - 2 Tubes<br><sup>b</sup> Fast-Cure Urethane/Dam/Primer - Quantity 2<br><sup>c</sup> Urethane,Dam,Primer - 1.5 Tubes |           |

**G3 4 Door Sedan (MEXICO Only)..... 2006-2008**

|   |           |
|---|-----------|
| <b>DW01695<sup>a b</sup></b> Windshield .....   | 36.2x53.8 |
| <b>DD10639-40</b> Door F/R-L .....  | 21.8x38.0 |
| <b>DD11286-87</b> Door R/R-L (2 Holes) .....  | 21.0x28.0 |
| <b>DB11288<sup>c</sup></b> Back Window (Ant)(Heated)(Solar) .....   | 27.0x47.5 |
| <sup>a</sup> Urethane,Dam,Primer - 2 Tubes<br><sup>b</sup> Fast-Cure Urethane/Dam/Primer - Quantity 2<br><sup>c</sup> Urethane,Dam,Primer - 1.5 Tubes |           |

**G3 Wave 4 Door Hatchback..... 2009-2010  
(CANADA Only)**

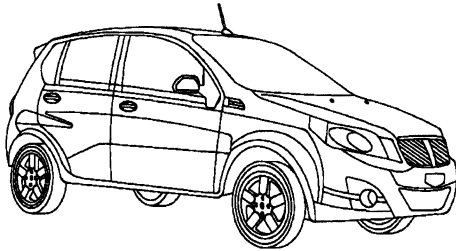

|   |                  |
|---|------------------|
| <b>DW01695<sup>a b</sup></b> Windshield .....                   | <b>36.2x53.8</b> |
| <b>DD10639-40</b> Door F/R-L .....                              | <b>21.8x38.0</b> |
| <b>DD11780-81</b> Door R/R-L .....                              | <b>19.0x24.5</b> |
| <b>DR10866</b> Roof (Solar) .....                               | <b>15.0x31.5</b> |
| <b>DQ10646-47<sup>d</sup></b> Quarter R-L .....                 | <b>9.0x14.5</b>  |
| <b>DB11706<sup>c</sup></b> Back Window (Heated) (W/Wiper) ..... | <b>18.5x52.5</b> |

- <sup>a</sup> Urethane,Dam,Primer - 2 Tubes
- <sup>b</sup> Fast-Cure Urethane/Dam/Primer - Quantity 2
- <sup>c</sup> Urethane,Dam,Primer - 1.5 Tubes
- <sup>d</sup> Urethane,Dam,Primer - 1 Tube

**G3 Wave 4 Door Sedan..... 2009-2010  
(CANADA Only)**

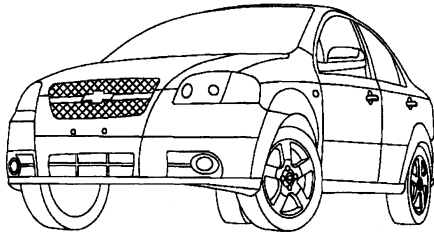

|   |                  |
|---|------------------|
| <b>DW01695<sup>a b</sup></b> Windshield .....                     | <b>36.2x53.8</b> |
| <b>DD10639-40</b> Door F/R-L .....                                | <b>21.8x38.0</b> |
| <b>DD11286-87</b> Door R/R-L (2 Holes) .....                      | <b>21.0x28.0</b> |
| <b>DR10866</b> Roof (Solar) .....                                 | <b>15.0x31.5</b> |
| <b>DB11288<sup>c</sup></b> Back Window (Ant)(Heated)(Solar) ..... | <b>27.0x47.5</b> |

- <sup>a</sup> Urethane,Dam,Primer - 2 Tubes
- <sup>b</sup> Fast-Cure Urethane/Dam/Primer - Quantity 2
- <sup>c</sup> Urethane,Dam,Primer - 1.5 Tubes

**G4 2 Door Coupe (MEXICO Only) ..... 2006**

|  |                  |
|--|------------------|
| <b>DW01605<sup>a b</sup></b> Windshield (Solar) (W/Third Visor Frit) ..... | <b>35.8x55.7</b> |
| <b>DD10870-71</b> Door F/R-L (Solar) .....                                 | <b>22.8x46.3</b> |
| <b>DQ10872-73<sup>c</sup></b> Quarter R-L (Encap)(Solar) .....             | <b>11.5x28.0</b> |
| <b>DB10874<sup>a</sup></b> Back Window (Encap)(Heated)(Solar) .....        | <b>37.5x55.0</b> |

- <sup>a</sup> Urethane,Dam,Primer - 2 Tubes
- <sup>b</sup> Fast-Cure Urethane/Dam/Primer - Quantity 2
- <sup>c</sup> Urethane,Dam,Primer - 1 Tube

**G4 4 Door Sedan (MEXICO Only) ..... 2006**

|  |                  |
|--|------------------|
| <b>DW01606<sup>a b</sup></b> Windshield (Solar) (W/Third Visor Frit) ..... | <b>36.9x56.0</b> |
| <b>DD10875-76</b> Door F/R-L (2 Holes)(Solar) .....                        | <b>22.0x35.0</b> |
| <b>DD10877-78</b> Door R/R-L (Solar) .....                                 | <b>21.0x26.0</b> |
| <b>DV10879-80</b> Vent R/R-L (Solar) .....                                 | <b>9.5x13.0</b>  |
| <b>DB10881<sup>c</sup></b> Back Window (Encap)(Heated)(Solar) .....        | <b>29.0x47.0</b> |

- <sup>a</sup> Urethane,Dam,Primer - 2 Tubes
- <sup>b</sup> Fast-Cure Urethane/Dam/Primer - Quantity 2

**G4 (cont.)**

<sup>c</sup> Urethane,Dam,Primer - 1.5 Tubes

**G5 2 Door Coupe..... 2007-2010**

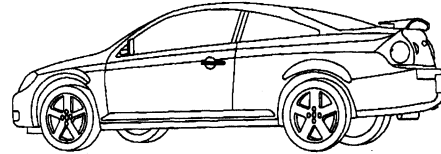

|  |                  |
|--|------------------|
| <b>DW01605<sup>a b</sup></b> Windshield (Solar) (W/Third Visor Frit) ..... | <b>35.8x55.7</b> |
| <b>DD10870-71</b> Door F/R-L (Solar) .....                                 | <b>22.8x46.3</b> |
| <b>DQ10872-73<sup>c</sup></b> Quarter R-L (Encap)(Solar) .....             | <b>11.5x28.0</b> |
| <b>DB10874<sup>a</sup></b> Back Window (Encap)(Heated)(Solar) .....        | <b>37.5x55.0</b> |

- <sup>a</sup> Urethane,Dam,Primer - 2 Tubes
- <sup>b</sup> Fast-Cure Urethane/Dam/Primer - Quantity 2
- <sup>c</sup> Urethane,Dam,Primer - 1 Tube

**G5 4 Door Sedan ..... 2007-2010**

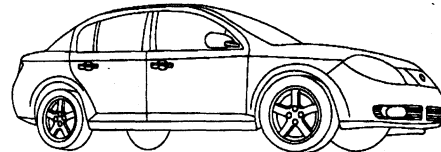

|  |                  |
|--|------------------|
| <b>DW01606<sup>a b</sup></b> Windshield (Solar) (W/Third Visor Frit) ..... | <b>36.9x56.0</b> |
| <b>DD10875-76</b> Door F/R-L (2 Holes)(Solar) .....                        | <b>22.0x35.0</b> |
| <b>DD10877-78</b> Door R/R-L (Solar) .....                                 | <b>21.0x26.0</b> |
| <b>DV10879-80</b> Vent R/R-L (Solar) .....                                 | <b>9.5x13.0</b>  |
| <b>DB10881<sup>c</sup></b> Back Window (Encap)(Heated)(Solar) .....        | <b>29.0x47.0</b> |

- <sup>a</sup> Urethane,Dam,Primer - 2 Tubes
- <sup>b</sup> Fast-Cure Urethane/Dam/Primer - Quantity 2
- <sup>c</sup> Urethane,Dam,Primer - 1.5 Tubes

**G6 2 Door Convertible ..... 2006-2009**

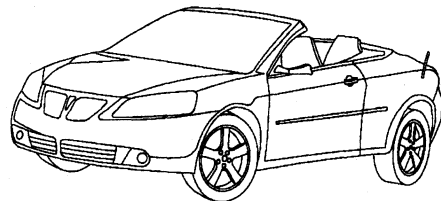

|  |                  |
|--|------------------|
| <b>DW01763<sup>a b</sup></b> Windshield (Solar) (W/Third Visor Frit, BMW Style Mirror Button) (08-09) .....    | <b>39.5x59.5</b> |
| <b>DW01629<sup>a b</sup></b> Windshield (Solar) (W/Third Visor Frit, Has GM Style Mirror Button) (06-07) ..... | <b>39.5x59.5</b> |
| <b>DD11073-74</b> Door F/R-L (Solar) .....   |                  |
| <b>DQ11356-57</b> Quarter R-L (Solar) .....  |                  |

|  |  |
|--|--|
| <b>DB11075<sup>c</sup></b> Back Window (Heated)(Solar) ..... |  |
|--|--|

- <sup>a</sup> Urethane,Dam,Primer - 2 Tubes
- <sup>b</sup> Fast-Cure Urethane/Dam/Primer - Quantity 2
- <sup>c</sup> Urethane,Dam,Primer - 1.5 Tubes

**G6 2 Door Coupe ..... 2006-2009**

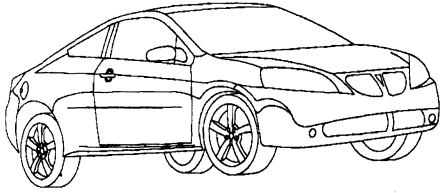

|  |           |
|--|-----------|
| DW01629 <sup>a,b</sup> Windshield (Solar) (W/Third Visor Frit, Has GM Style Mirror Button) ..... | 39.5x59.5 |
| DD10999-00 Door F/R-L (Solar) .....  | 19.5x47.5 |
| DQ11001-02 <sup>d</sup> Quarter R-L (Encap)(Solar) .....   | 13.0x31.0 |
| DB11003 <sup>c</sup> Back Window (Ant)(Heated)(Solar) .....                                      | 37.0x42.5 |

<sup>a</sup> Urethane,Dam,Primer - 2 Tubes  
<sup>b</sup> Fast-Cure Urethane/Dam/Primer - Quantity 2  
<sup>c</sup> Urethane,Dam,Primer - 1.5 Tubes  
<sup>d</sup> Urethane,Dam,Primer - 1 Tube

**G6 4 Door Sedan ..... 2006-2010**

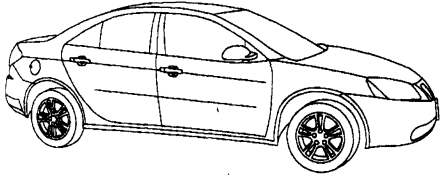

|  |           |
|--|-----------|
| DW01603 <sup>a,b</sup> Windshield (Solar) (W/Third Visor Frit) ..... | 39.0x59.7 |
| DD10854-55 Door F/R-L (Solar) .....                                  | 20.5x37.3 |
| DD10856-57 Door R/R-L (1 Holes)(Solar) .....                         | 20.0x24.5 |
| DR10862 Roof F (Solar) (Panoramic) .....                             |           |
| DR10863 Roof M (Solar) (Panoramic) .....                             |           |
| DR10864 Roof R (Solar) (Panoramic) .....                             |           |
| DR10861 Roof (Encap)(Solar) (One-Piece) .....                        | 17.0x28.8 |
| DV10858-59 Vent R/R-L (Solar) .....                                  | 9.4x15.2  |
| DB10860 <sup>a</sup> Back Window (Heated)(Solar) .....               | 35.0x48.5 |

<sup>a</sup> Urethane,Dam,Primer - 2 Tubes  
<sup>b</sup> Fast-Cure Urethane/Dam/Primer - Quantity 2

**G8 4 Door Sedan ..... 2008-2009**

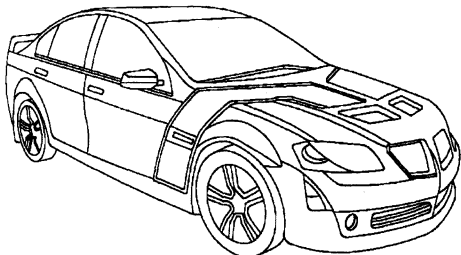

|   |           |
|---|-----------|
| DW01870 <sup>a,c,d</sup> Windshield (Solar) (Aftermarket) (From 9L159427) ...                               | 38.7x56.4 |
| DW01869 <sup>a,c,d</sup> Windshield (Solar) (Aftermarket) (To 9L159426) .....                               | 38.7x56.4 |
| DW01805 <sup>b,c,d</sup> Windshield (Solar) (Acoustic Interlayer) (From 9L159427) (09) .....                | 38.7x56.4 |
| DW01800 <sup>b,c,d,e</sup> Windshield (Solar) (Acoustic Interlayer, Rain Sensor) (From 9L159427) (09) ..... | 38.7x56.4 |
| DW01773 <sup>b,c,d</sup> Windshield (Solar) (Acoustic Interlayer) (To 9L159426) .....                       | 38.7x56.4 |
| DD11607-08 Door F/R-L (Solar) .....   | 23.0x36.8 |
| DD11609-10 Door R/R-L (Solar) .....   | 21.3x27.0 |
| DV11611-12 Vent R/R-L (Encap)(Solar) .....  | 11.0x12.0 |
| DB11613 <sup>c</sup> Back Window (Heated)(Solar) .....  | 34.3x48.5 |

<sup>a</sup> Not On Production Vehicles

**G8 (cont.)**

<sup>b</sup> On Production Vehicles  
<sup>c</sup> Urethane,Dam,Primer - 2 Tubes  
<sup>d</sup> Fast-Cure Urethane/Dam/Primer - Quantity 2  
<sup>e</sup> Rain Sensor Kit

**GTO 2 Door Coupe ..... 2006 (USA Only)**

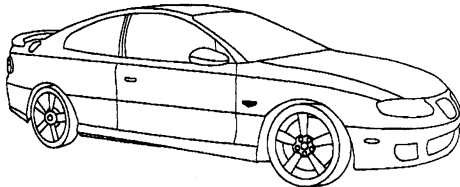

|  |           |
|--|-----------|
| DW01532 <sup>a,b</sup> Windshield (Solar) .....          | 35.4x60.0 |
| DD10493-94 Door F/R-L (Encap)(Solar) .....               | 20.0x39.3 |
| DQ10495-96 <sup>d</sup> Quarter R-L (Encap)(Solar) ..... | 15.8x31.0 |
| DB10497 <sup>c</sup> Back Window (Ant)(Heated) .....     | 35.0x45.7 |

<sup>a</sup> Urethane,Dam,Primer - 2 Tubes  
<sup>b</sup> Fast-Cure Urethane/Dam/Primer - Quantity 2  
<sup>c</sup> Urethane,Dam,Primer - 1.5 Tubes  
<sup>d</sup> Urethane,Dam,Primer - 1 Tube

**Grand Prix 4 Door Sedan ..... 2006-2008**

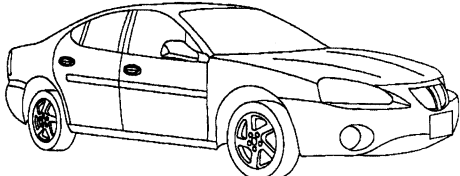

|  |           |
|--|-----------|
| DW01652 <sup>a,b</sup> Windshield (HUD)(Solar) (W/Third Visor Frit) (From 12/01/2005) .....  | 40.0x63.0 |
| DW01651 <sup>a,b</sup> Windshield (Solar) (W/Third Visor Frit) (From 12/01/2005) .....       | 40.0x63.0 |
| DW01492 <sup>a,b</sup> Windshield (HUD)(Solar) (To 11/30/2005) (06) .....                    | 40.0x63.0 |
| DW01491 <sup>a,b</sup> Windshield (Solar) (To 11/30/2005) (06) .....                         | 40.0x63.0 |
| DD10211-12 Door F/R-L (Solar) .....  | 23.0x38.0 |
| DD10213-14 Door R/R-L (Solar) .....  | 22.0x25.0 |
| DV10215-16 Vent R/R-L (Encap)(Solar) .....   | 11.0x16.0 |
| DB10843 <sup>a</sup> Back Window (Heated)(Solar) (W/Remote Entry Lock, W/Remote Start) ..... | 41.0x53.0 |
| DB10217 <sup>a</sup> Back Window (Heated)(Solar) (W/Remote Entry Lock) .....                 | 41.0x53.0 |

<sup>a</sup> Urethane,Dam,Primer - 2 Tubes  
<sup>b</sup> Fast-Cure Urethane/Dam/Primer - Quantity 2

**Matiz 4 Door Hatchback (MEXICO ONLY) ..... 2006-2009**

|  |  |
|--|--|
| DW01671 <sup>a,b</sup> Windshield (Mexico Only) .....  |  |
| DD11231-32 Door F/R-L (Mexico Only) .....  |  |
| DD11233-34 Door R/R-L (Mexico Only) .....  |  |
| DV11229-30 Vent F/R-L (Mexico Only) .....  |  |
| DB11912 <sup>c</sup> Back Window (Heated)(4 Holes) (Mexico Only, W/ Spoiler, High Mount Brake Light) ..... |  |
| DB11911 <sup>c</sup> Back Window (Heated) (Mexico Only, High Mount Brake Light) .....                      |  |
| DB11235 <sup>c</sup> Back Window (Heated) (Mexico Only) .....  |  |

<sup>a</sup> Urethane,Dam,Primer - 2 Tubes  
<sup>b</sup> Fast-Cure Urethane/Dam/Primer - Quantity 2

**Matiz (cont.)**

<sup>c</sup> Urethane,Dam,Primer - 1.5 Tubes

**Montana SV6 Mini Van ..... 2006-2009**

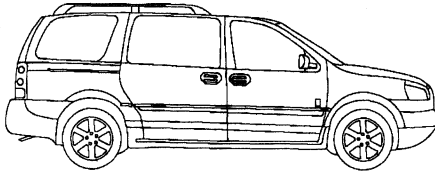

|  |                  |
|--|------------------|
| <b>DW01722<sup>a c d</sup></b> Windshield (Solar) (W/Third Visor Frit) (From 06/01/2007) (07-09) ..... | <b>48.2x62.1</b> |
| <b>DW01574<sup>a c d</sup></b> Windshield (Solar) (To 05/31/2007) (06-07) .....                        | <b>48.2x62.1</b> |
| <b>DD10714-15</b> Door F/R-L (2 Holes)(Solar) .....  | <b>24.8x37.5</b> |
| <b>DD11029-30<sup>b</sup></b> Door R/R-L (Encap)(Solar) (Sliding Cargo Door) .....                     | <b>24.5x42.4</b> |
| <b>DD10997-98<sup>b</sup></b> Door R/R-L (Solar) (Sliding Cargo Door, Extended Van) .....              | <b>24.5x45.5</b> |
| <b>DQ10851-52</b> Quarter R-L (Encap)(Solar) .....   | <b>21.5x35.0</b> |
| <b>DQ10718-19</b> Quarter R-L (Encap)(1 Holes)(Solar) (Extended Van) ..                                |                  |
| <b>DB10868<sup>b</sup></b> Back Window (Solar) .....   | <b>23.4x57.3</b> |
| <b>DB10720<sup>b</sup></b> Back Window (Heated)(1 Holes)(Solar) (W/Wiper) ...                          | <b>23.4x57.3</b> |

<sup>a</sup> May Require Two Person Installation  
<sup>b</sup> Urethane,Dam,Primer - 1.5 Tubes  
<sup>c</sup> Urethane,Dam,Primer - 2.5 Tubes  
<sup>d</sup> Fast-Cure Urethane/Dam/Primer - Quantity 2.5

**Pursuit 2 Door Coupe..... 2006-2007 (CANADA Only)**

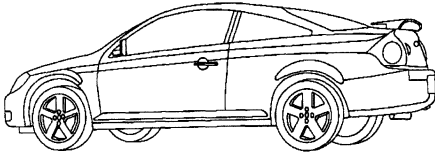

|  |                  |
|--|------------------|
| <b>DW01605<sup>a b</sup></b> Windshield (Solar) (W/Third Visor Frit) ..... | <b>35.8x55.7</b> |
| <b>DD10870-71</b> Door F/R-L (Solar) .....                                 | <b>22.8x46.3</b> |
| <b>DQ10872-73<sup>c</sup></b> Quarter R-L (Encap)(Solar) .....             | <b>11.5x28.0</b> |
| <b>DB10874<sup>a</sup></b> Back Window (Encap)(Heated)(Solar) .....        | <b>37.5x55.0</b> |

<sup>a</sup> Urethane,Dam,Primer - 2 Tubes  
<sup>b</sup> Fast-Cure Urethane/Dam/Primer - Quantity 2  
<sup>c</sup> Urethane,Dam,Primer - 1 Tube

**Pursuit 4 Door Sedan ..... 2006-2007 (CANADA Only)**

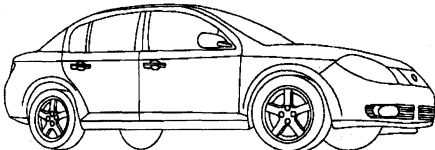

|  |                  |
|--|------------------|
| <b>DW01606<sup>a b</sup></b> Windshield (Solar) (W/Third Visor Frit) ..... | <b>36.9x56.0</b> |
| <b>DD10875-76</b> Door F/R-L (2 Holes)(Solar) .....                        | <b>22.0x35.0</b> |
| <b>DD10877-78</b> Door R/R-L (Solar) .....                                 | <b>21.0x26.0</b> |
| <b>DV10879-80</b> Vent R/R-L (Solar) .....                                 | <b>9.5x13.0</b>  |
| <b>DB10881<sup>c</sup></b> Back Window (Encap)(Heated)(Solar) .....        | <b>29.0x47.0</b> |

<sup>a</sup> Urethane,Dam,Primer - 2 Tubes  
<sup>b</sup> Fast-Cure Urethane/Dam/Primer - Quantity 2  
<sup>c</sup> Urethane,Dam,Primer - 1.5 Tubes

**Solstice 2 Door Convertible..... 2006-2009**

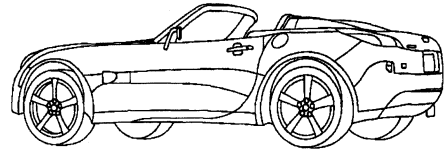

|  |                  |
|--|------------------|
| <b>DW01642<sup>a b</sup></b> Windshield (Solar) .....              | <b>27.4x58.0</b> |
| <b>DD11071-72</b> Door F/R-L (Solar) .....                         | <b>16.5x37.0</b> |
| <b>DB11315</b> Back Window (Heated)(Solar) (Aftermarket Only) .... |                  |

<sup>a</sup> Urethane,Dam,Primer - 2 Tubes  
<sup>b</sup> Fast-Cure Urethane/Dam/Primer - Quantity 2

**Solstice 2 Door Coupe ..... 2009**

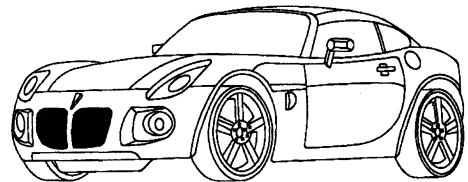

|  |  |
|--|--|
| <b>DW01812<sup>a b</sup></b> Windshield (Solar) (W/Third Visor Frit) ..... |  |
| <b>DD11695-96</b> Door F/R-L (Solar) .....                                 |  |
| <b>DQ11697-98<sup>c</sup></b> Quarter R-L (Encap)(Solar) .....             |  |
| <b>DB11699<sup>c</sup></b> Back Window (Heated)(Solar) .....               |  |

<sup>a</sup> Urethane,Dam,Primer - 2 Tubes  
<sup>b</sup> Fast-Cure Urethane/Dam/Primer - Quantity 2  
<sup>c</sup> Urethane,Dam,Primer - 1.5 Tubes

**Torrent 4 Door Utility ..... 2006-2009**

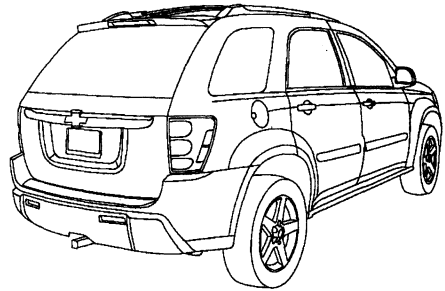

|  |                  |
|--|------------------|
| <b>DW01613<sup>a c d</sup></b> Windshield (Solar) (W/Third Visor Frit, Acoustic Inter-layer) .....   | <b>37.4x51.1</b> |
| <b>DW01583<sup>b c d</sup></b> Windshield (Solar) (W/Third Visor Frit) .....                         | <b>37.4x51.1</b> |
| <b>DD10760-61</b> Door F/R-L (1 Holes)(Solar) .....  | <b>22.7x34.8</b> |
| <b>DD10762-63</b> Door R/R-L (1 Holes)(Solar) .....  | <b>21.2x31.4</b> |
| <b>DR09570</b> Roof (Solar) (07-09) .....  |                  |
| <b>DQ11489<sup>f</sup></b> Quarter R (Ant)(Encap)(Solar) (W/Remote Start) (To 01/15/2007) (07) ..... | <b>17.3x32.3</b> |
| <b>DQ11478<sup>f</sup></b> Quarter R (Ant)(Solar) (W/Remote Start) (From 01/15/2007) (07-09) .....   | <b>17.3x32.3</b> |
| <b>DQ11476-77<sup>f</sup></b> Quarter R-L (Solar) (From 01/15/2007) (07-09) .....                    | <b>17.3x32.3</b> |
| <b>DQ10764-65<sup>f</sup></b> Quarter R-L (Encap)(Solar) (To 01/15/2007) (06-07) ...                 | <b>16.2x32.0</b> |
| <b>DB10766<sup>e</sup></b> Back Window (Heated)(Solar) .....   | <b>25.1x51.1</b> |

<sup>a</sup> On Production Vehicles  
<sup>b</sup> Not On Production Vehicles 2006-09  
<sup>c</sup> Urethane,Dam,Primer - 2 Tubes  
<sup>d</sup> Fast-Cure Urethane/Dam/Primer - Quantity 2  
<sup>e</sup> Urethane,Dam,Primer - 1.5 Tubes  
<sup>f</sup> Urethane,Dam,Primer - 1 Tube

**Vibe 4 Door Hatchback ..... 2009-2010**

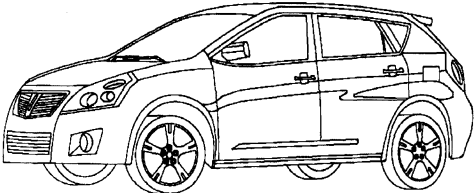

|   |                  |
|---|------------------|
| <b>DW01756<sup>a b</sup></b> Windshield (W/Third Visor Frit) .....    | <b>37.0x54.5</b> |
| <b>DD11544-45</b> Door F/R-L (Solar) .....                            | <b>19.8x37.0</b> |
| <b>DD11546-47</b> Door R/R-L (Solar) .....                            | <b>19.5x28.3</b> |
| <b>DQ11548-49<sup>d</sup></b> Quarter R-L (Encap)(Solar) .....        | <b>12.5x14.0</b> |
| <b>DB11550<sup>c</sup></b> Back Window (Heated)(1 Holes)(Solar) ..... | <b>18.5x39.0</b> |

<sup>a</sup> Urethane,Dam,Primer - 2 Tubes  
<sup>b</sup> Fast-Cure Urethane/Dam/Primer - Quantity 2  
<sup>c</sup> Urethane,Dam,Primer - 1.5 Tubes  
<sup>d</sup> Urethane,Dam,Primer - 1 Tube

**Vibe 4 Door Hatchback ..... 2006-2008**

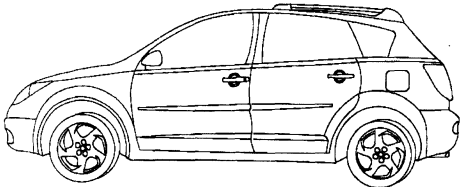

|  |                  |
|--|------------------|
| <b>DW01489<sup>a b</sup></b> Windshield (Solar) .....          | <b>36.0x55.8</b> |
| <b>DD10188-89</b> Door F/R-L (Solar) .....                     | <b>19.0x33.0</b> |
| <b>DD10190-91</b> Door R/R-L (Solar) .....                     | <b>19.0x27.0</b> |
| <b>DQ10192-93<sup>c</sup></b> Quarter R-L (Encap)(Solar) ..... | <b>14.5x18.0</b> |
| <b>DB10194</b> Back Window (Heated)(13 Holes)(Solar) .....     | <b>18.8x49.0</b> |

<sup>a</sup> Urethane,Dam,Primer - 2 Tubes  
<sup>b</sup> Fast-Cure Urethane/Dam/Primer - Quantity 2  
<sup>c</sup> Urethane,Dam,Primer - 1 Tube

**Wave 4 Door Hatchback..... 2006-2008  
(CANADA Only)**

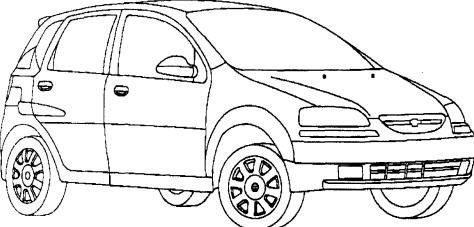

|  |                  |
|--|------------------|
| <b>DW01561<sup>a b</sup></b> Windshield .....                            | <b>36.9x53.8</b> |
| <b>DD10639-40</b> Door F/R-L .....                                       | <b>21.8x38.0</b> |
| <b>DD10644-45</b> Door R/R-L .....                                       | <b>19.0x24.5</b> |
| <b>DR10866</b> Roof (Solar) .....  | <b>15.0x31.5</b> |
| <b>DQ10646-47<sup>d</sup></b> Quarter R-L .....                          | <b>9.0x14.5</b>  |
| <b>DB10648<sup>c</sup></b> Back Window (Heated)(1 Holes) (W/Wiper) ..... | <b>19.0x54.5</b> |

<sup>a</sup> Urethane,Dam,Primer - 2 Tubes  
<sup>b</sup> Fast-Cure Urethane/Dam/Primer - Quantity 2  
<sup>c</sup> Urethane,Dam,Primer - 1.5 Tubes  
<sup>d</sup> Urethane,Dam,Primer - 1 Tube

**Wave 4 Door Sedan..... 2007-2008  
(CANADA Only)**

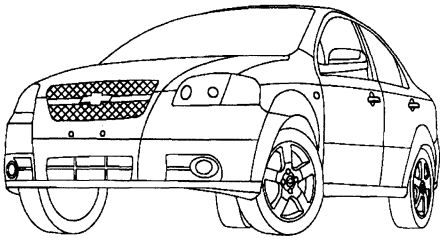

|   |                  |
|---|------------------|
| <b>DW01695<sup>a b</sup></b> Windshield .....                     | <b>36.2x53.8</b> |
| <b>DD10639-40</b> Door F/R-L .....                                | <b>21.8x38.0</b> |
| <b>DD11286-87</b> Door R/R-L (2 Holes) .....                      | <b>21.0x28.0</b> |
| <b>DR10866</b> Roof (Solar) .....                                 | <b>15.0x31.5</b> |
| <b>DB11288<sup>c</sup></b> Back Window (Ant)(Heated)(Solar) ..... | <b>27.0x47.5</b> |

<sup>a</sup> Urethane,Dam,Primer - 2 Tubes  
<sup>b</sup> Fast-Cure Urethane/Dam/Primer - Quantity 2  
<sup>c</sup> Urethane,Dam,Primer - 1.5 Tubes

**Wave 4 Door Sedan..... 2006  
(CANADA Only)**

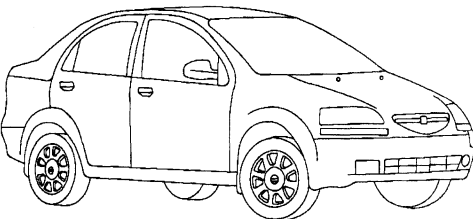

|   |                  |
|---|------------------|
| <b>DW01561<sup>a b</sup></b> Windshield .....         | <b>36.9x53.8</b> |
| <b>DD10639-40</b> Door F/R-L .....                    | <b>21.8x38.0</b> |
| <b>DD10641-42</b> Door R/R-L .....                    | <b>21.3x27.3</b> |
| <b>DR10866</b> Roof (Solar) .....                     | <b>15.0x31.5</b> |
| <b>DB10643<sup>c</sup></b> Back Window (Heated) ..... | <b>25.0x46.0</b> |

<sup>a</sup> Urethane,Dam,Primer - 2 Tubes  
<sup>b</sup> Fast-Cure Urethane/Dam/Primer - Quantity 2  
<sup>c</sup> Urethane,Dam,Primer - 1.5 Tubes

**Porsche**

**911 Carrera 2 Door Convertible ..... 2006-2010**  
**911 Turbo 2 Door Convertible ..... 2007-2010**

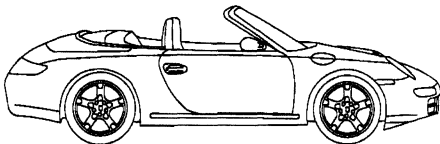

|   |                  |
|---|------------------|
| <b>FW02554<sup>a</sup></b> Windshield (Ant)(Encap) (Rain Sensor, W/GPS Antenna) (06-10) ..... | <b>31.9x58.3</b> |
| <b>FD22610-11</b> Door F/R-L (Solar) (06-10) .....  | <b>16.0x34.0</b> |
| <b>FQ24314-15</b> Quarter R-L (Solar) (09-10) .....   | <b>11.0x13.5</b> |
| <b>FQ22612-13</b> Quarter R-L (Solar) (06-08) .....   | <b>11.0x13.5</b> |
| <b>FB24317<sup>b</sup></b> Back Window (Heated)(Solar) (Hardtop) (06-10) .....                | <b>14.0x35.5</b> |
| <b>FB24316</b> Back Window (Heated)(Solar) (09-10) .....                                      | <b>14.0x35.5</b> |
| <b>FB22614</b> Back Window (Heated)(Solar) (06-08) .....                                      | <b>14.0x35.5</b> |

<sup>a</sup> High Modulus Non-Conductive Urethane,Dam,Primer - 2 Tubes  
<sup>b</sup> High Modulus Non-Conductive Urethane,Dam,Primer - 1.5 Tubes



|                                      |                  |
|--------------------------------------|------------------|
| <b>911 Carrera</b> 2 Door Coupe..... | <b>2006-2010</b> |
| <b>911 GT2</b> 2 Door Coupe.....     | <b>2008-2010</b> |
| <b>911 GT3</b> 2 Door Coupe.....     | <b>2007-2010</b> |
| <b>911 Turbo</b> 2 Door Coupe.....   | <b>2007-2010</b> |

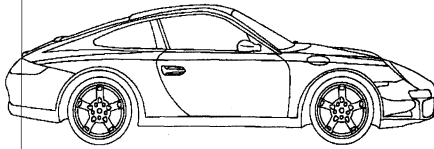

|  |                  |
|--|------------------|
| <b>FW02554<sup>a</sup></b> Windshield (Ant)(Encap)(Rain Sensor, W/GPS Antenna) (06-10) .....   | <b>31.9x58.3</b> |
| <b>FD22604-05</b> Door F/R-L (Solar) (06-10) .....   | <b>15.0x36.0</b> |
| <b>FQ22606-07<sup>c</sup></b> Quarter R-L (Solar) (06-10) .....                                | <b>13.0x29.0</b> |
| <b>FB22609<sup>b</sup></b> Back Window (Encap)(Heated)(1 Holes)(Solar) (W/Wiper) (06-10) ..... | <b>32.0x41.0</b> |
| <b>FB22608<sup>b</sup></b> Back Window (Encap)(Heated)(Solar) (06-10) .....                    | <b>32.0x41.0</b> |

<sup>a</sup> High Modulus Non-Conductive Urethane,Dam,Primer - 2 Tubes  
<sup>b</sup> High Modulus Non-Conductive Urethane,Dam,Primer - 1.5 Tubes  
<sup>c</sup> High Modulus Non-Conductive Urethane,Dam,Primer - 1 Tube

|                                    |                  |
|------------------------------------|------------------|
| <b>911 Targa</b> 2 Door Coupe..... | <b>2007-2010</b> |
|------------------------------------|------------------|

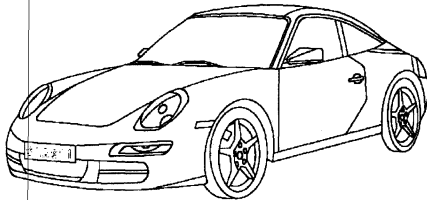

|  |                  |
|--|------------------|
| <b>FW02554<sup>a</sup></b> Windshield (Ant)(Encap)(Rain Sensor, W/GPS Antenna) ..... | <b>31.9x58.3</b> |
| <b>FD22604-05</b> Door F/R-L (Solar) .....   | <b>15.0x36.0</b> |
| <b>FR23531</b> Roof (Solar) .....  |                  |
| <b>FQ23529-30</b> Quarter R-L (Solar) .....  |                  |
| <b>FB23532</b> Back Window (Heated)(1 Holes)(Solar) (Gasket Set) ..                  |                  |

<sup>a</sup> High Modulus Non-Conductive Urethane,Dam,Primer - 2 Tubes

|  |             |
|--|-------------|
| <b>911 Turbo</b> 2 Door Convertible..... | <b>2006</b> |
|--|-------------|

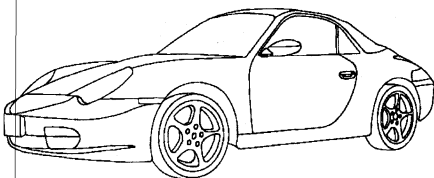

|  |                  |
|--|------------------|
| <b>FW02790<sup>a,c</sup></b> Windshield (Ant)(Solar) (Electrochromic Mirror, Aftermarket, Rain Sensor) ..... | <b>30.5x59.5</b> |
| <b>FW02789<sup>a,c</sup></b> Windshield (Ant)(Solar) (Aftermarket) .....                                     | <b>30.5x59.5</b> |
| <b>FW02377<sup>b,c</sup></b> Windshield (Ant)(Solar) (Electrochromic Mirror, PAAS System, Rain Sensor) ..... | <b>30.5x59.5</b> |
| <b>FW02376<sup>b,c</sup></b> Windshield (Ant)(Solar) (PAAS System) .....                                     | <b>31.8x58.2</b> |
| <b>FD20474-75</b> Door F/R-L .....   | <b>17.5x38.0</b> |
| <b>FQ20478-79</b> Quarter R-L .....  | <b>10.5x13.4</b> |

<sup>a</sup> Not On Production Vehicles  
<sup>b</sup> On Production Vehicles  
<sup>c</sup> High Modulus Non-Conductive Urethane,Dam,Primer - 2 Tubes

|                                    |             |
|------------------------------------|-------------|
| <b>911 Turbo</b> 2 Door Coupe..... | <b>2006</b> |
|------------------------------------|-------------|

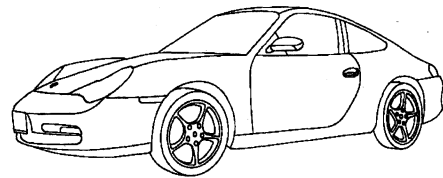

|  |                  |
|--|------------------|
| <b>FW02790<sup>a,c</sup></b> Windshield (Ant)(Solar) (Electrochromic Mirror, Aftermarket, Rain Sensor) ..... | <b>30.5x59.5</b> |
| <b>FW02789<sup>a,c</sup></b> Windshield (Ant)(Solar) (Aftermarket) .....                                     | <b>30.5x59.5</b> |
| <b>FW02377<sup>b,c</sup></b> Windshield (Ant)(Solar) (Electrochromic Mirror, PAAS System, Rain Sensor) ..... | <b>30.5x59.5</b> |
| <b>FW02376<sup>b,c</sup></b> Windshield (Ant)(Solar) (PAAS System) .....                                     | <b>31.8x58.2</b> |
| <b>FD20472-73</b> Door F/R-L .....   | <b>17.5x36.5</b> |
| <b>FQ20476-77<sup>e</sup></b> Quarter R-L .....  | <b>13.3x29.6</b> |
| <b>FB20480<sup>d</sup></b> Back Window (Heated) (PAAS System) .....  | <b>29.7x41.0</b> |

<sup>a</sup> Not On Production Vehicles  
<sup>b</sup> On Production Vehicles  
<sup>c</sup> High Modulus Non-Conductive Urethane,Dam,Primer - 2 Tubes  
<sup>d</sup> High Modulus Non-Conductive Urethane,Dam,Primer - 1.5 Tubes  
<sup>e</sup> High Modulus Non-Conductive Urethane,Dam,Primer - 1 Tube

|  |                  |
|--|------------------|
| <b>Boxster</b> 2 Door Convertible..... | <b>2006-2010</b> |
|--|------------------|

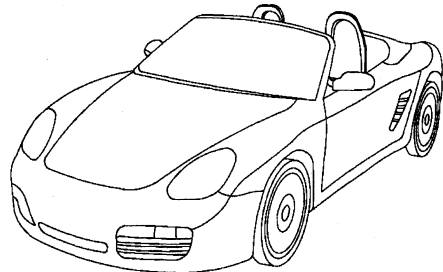

|  |                  |
|--|------------------|
| <b>FW02661<sup>a</sup></b> Windshield (Ant)(Solar) (PAAS System, W/Phone Antenna, Rain Sensor) ..... | <b>28.9x58.4</b> |
| <b>FW02660<sup>a</sup></b> Windshield (Ant)(Solar) (PAAS System, W/Phone Antenna) .....              | <b>28.9x58.4</b> |
| <b>FW02659<sup>a</sup></b> Windshield (Ant)(Solar) (PAAS System, Rain Sensor) .....                  | <b>28.9x58.4</b> |
| <b>FW02626<sup>a</sup></b> Windshield (Ant)(Solar) (PAAS System) .....                               | <b>28.9x58.4</b> |
| <b>FD23109-10</b> Door F/R-L (Solar) .....   |                  |

<sup>a</sup> High Modulus Non-Conductive Urethane,Dam,Primer - 2 Tubes

|                                    |             |
|------------------------------------|-------------|
| <b>Cayenne</b> 4 Door Utility..... | <b>2011</b> |
|------------------------------------|-------------|

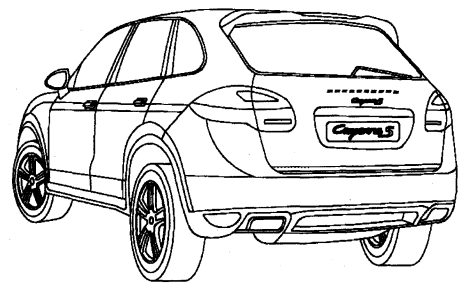

|   |                  |
|---|------------------|
| <b>FW03289<sup>a</sup></b> Windshield (Heated)(Solar) (PAAS System, W/Third Visor Frit, Acoustic Interlayer, Rain/Light Sensor, Solar Coated) ..... | <b>37.4x61.0</b> |
|---|------------------|

| <b>Cayenne (cont.)</b>        |   |
|-------------------------------|---|
| <b>FW03288<sup>a</sup></b>    | Windshield (Heated)(Solar) (PAAS System, W/Third Visor Frit, Acoustic Interlayer, Rain/Light Sensor) ..... <b>37.4x61.0</b> |
| <b>FW03287<sup>a</sup></b>    | Windshield (Solar) (PAAS System, W/Third Visor Frit, Acoustic Interlayer, Rain/Light Sensor) ..... <b>37.4x61.0</b>         |
| <b>FD24750-51</b>             | Door F/R-L (Solar) (Laminated, Hydrophobic Coating, Solar Coated) ..... <b>22.0x35.9</b>                                    |
| <b>FD24748-49</b>             | Door F/R-L (Solar) (Hydrophobic Coating) ..... <b>22.0x35.9</b>   |
| <b>FD24752-53</b>             | Door R/R-L (Solar) ..... <b>22.0x35.9</b>   |
| <b>FQ24754-55<sup>b</sup></b> | Quarter R-L (Encap)(Solar) ..... <b>22.0x35.9</b>   |
| <b>FV24746-47<sup>b</sup></b> | Vent F/R-L (Encap)(Solar) ..... <b>22.0x35.9</b>  |
| <b>FB24758<sup>b</sup></b>    | Back Window (Ant)(Heated)(1 Holes)(Solar) (Laminated, W/Wiper, Solar Coated, W/TV Antenna) ..... <b>23.0x50.5</b>           |
| <b>FB24757<sup>b</sup></b>    | Back Window (Ant)(Heated)(1 Holes)(Solar) (W/Wiper, W/TV Antenna) ..... <b>23.0x50.5</b>                                    |
| <b>FB24756<sup>b</sup></b>    | Back Window (Ant)(Heated)(1 Holes)(Solar) (W/Wiper) ..... <b>23.0x50.5</b>  |

<sup>a</sup> High Modulus Non-Conductive Urethane,Dam,Primer - 2 Tubes  
<sup>b</sup> High Modulus Non-Conductive Urethane,Dam,Primer - 1.5 Tubes

**Cayenne 4 Door Utility ..... 2006-2010**

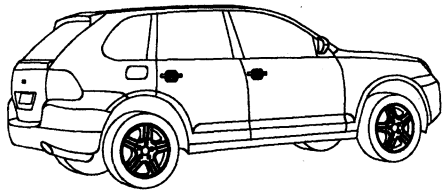

|                               |   |
|-------------------------------|---|
| <b>FW02885<sup>a</sup></b>    | Windshield (Solar) (PAAS System, W/Third Visor Frit, Solar Coated, Rain Sensor) (From 01/2007) (07-10) ..... <b>39.4x62.4</b> |
| <b>FW02884<sup>a</sup></b>    | Windshield (Solar) (PAAS System, W/Third Visor Frit, Rain Sensor) (From 01/2007) (07-10) ..... <b>39.4x62.4</b>               |
| <b>FW02409<sup>a</sup></b>    | Windshield (Solar) (PAAS System, Solar Coated, Rain Sensor) (To 01/2007) (06-07) ..... <b>39.4x62.4</b>                       |
| <b>FW02408<sup>a</sup></b>    | Windshield (Solar) (PAAS System, Rain Sensor) (To 01/2007) (06-07) ..... <b>39.4x62.4</b>                                     |
| <b>FD22053-54</b>             | Door F/R-L (Solar) (Laminated, Solar Coated) ..... <b>21.0x34.0</b>   |
| <b>FD22051-52</b>             | Door F/R-L (Solar) ..... <b>21.0x34.0</b>   |
| <b>FD22057-58</b>             | Door R/R-L (Solar) (Laminated, Solar Coated) ..... <b>22.0x29.0</b>   |
| <b>FD22055-56</b>             | Door R/R-L (Solar) ..... <b>22.0x29.0</b>   |
| <b>FQ22061-62<sup>b</sup></b> | Quarter R-L (Encap)(Solar) (Laminated, Solar Coated) ..... <b>17.0x18.0</b>   |
| <b>FQ22059-60<sup>b</sup></b> | Quarter R-L (Encap)(Solar) ..... <b>17.0x18.0</b>   |
| <b>FB22317</b>                | Back Window (Ant)(Encap)(Heated)(1 Holes)(Solar) (Laminated, W/Diversity Antenna, Solar Coated) ..... <b>22.5x48.0</b>        |
| <b>FB22065</b>                | Back Window (Ant)(Encap)(Heated)(Solar) (W/Diversity Antenna) ..... <b>22.5x48.0</b>  |
| <b>FB22064</b>                | Back Window (Encap)(Heated)(1 Holes)(Solar) (Laminated, Solar Coated) ..... <b>22.5x48.0</b>                                  |
| <b>FB22063</b>                | Back Window (Encap)(Heated)(1 Holes)(Solar) ..... <b>22.5x48.0</b>  |

<sup>a</sup> High Modulus Non-Conductive Urethane,Dam,Primer - 2 Tubes  
<sup>b</sup> High Modulus Non-Conductive Urethane,Dam,Primer - 1 Tube

**Cayman 2 Door Coupe ..... 2006-2010**

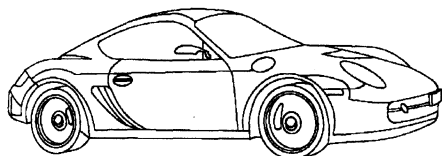

|                            |  |
|----------------------------|--|
| <b>FW02661<sup>a</sup></b> | Windshield (Ant)(Solar) (PAAS System, W/Phone Antenna, Rain Sensor) ..... <b>28.9x58.4</b> |
| <b>FW02660<sup>a</sup></b> | Windshield (Ant)(Solar) (PAAS System, W/Phone Antenna) ..... <b>28.9x58.4</b>              |

| <b>Cayman (cont.)</b>         |   |
|-------------------------------|---|
| <b>FW02659<sup>a</sup></b>    | Windshield (Ant)(Solar) (PAAS System, Rain Sensor) ..... <b>28.9x58.4</b> |
| <b>FW02626<sup>a</sup></b>    | Windshield (Ant)(Solar) (PAAS System) ..... <b>28.9x58.4</b>              |
| <b>FD22923-24</b>             | Door F/R-L (Solar) ..... <b>14.0x35.0</b>                                 |
| <b>FQ22925-26<sup>c</sup></b> | Quarter R-L (Encap)(Solar) ..... <b>10.0x13.0</b>                         |
| <b>FB22927<sup>b</sup></b>    | Back Window (Heated)(Solar) ..... <b>26.0x38.0</b>                        |

<sup>a</sup> High Modulus Non-Conductive Urethane,Dam,Primer - 2 Tubes  
<sup>b</sup> High Modulus Non-Conductive Urethane,Dam,Primer - 1.5 Tubes  
<sup>c</sup> High Modulus Non-Conductive Urethane,Dam,Primer - 1 Tube

**Panamera 4 Door Sedan ..... 2010-2011**

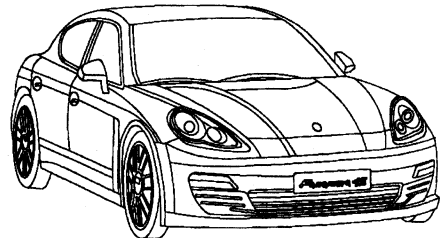

|                            |  |
|----------------------------|--|
| <b>FW03173<sup>a</sup></b> | Windshield (Solar) (W/Third Visor Frit, Acoustic Interlayer, Rain Sensor) ..... <b>37.0x59.5</b> |
| <b>FD24484-85</b>          | Door F/R-L (Solar) ..... <b>19.0x27.0</b>  |
| <b>FD24486-87</b>          | Door R/R-L (Solar) ..... <b>18.0x23.0</b>  |
| <b>FV24482-83</b>          | Vent F/R-L (Solar) ..... <b>8.0x 9.5</b>   |
| <b>FV24490-91</b>          | Vent R/R-L (Solar) (W/Sun Blind) ..... <b>12.0x13.0</b>  |
| <b>FV24488-89</b>          | Vent R/R-L (Solar) ..... <b>12.0x13.0</b>  |
| <b>FB24495<sup>b</sup></b> | Back Window (Ant)(Heated)(1 Holes)(Solar) (W/Wiper) ..... <b>28.3x40.3</b>                       |
| <b>FB24494<sup>b</sup></b> | Back Window (Heated)(1 Holes)(Solar) (W/Wiper) ... <b>28.3x40.3</b>                              |
| <b>FB24493<sup>b</sup></b> | Back Window (Ant)(Heated)(Solar) ..... <b>28.3x40.3</b>  |
| <b>FB24492<sup>b</sup></b> | Back Window (Heated)(Solar) ..... <b>28.3x40.3</b>   |

<sup>a</sup> High Modulus Non-Conductive Urethane,Dam,Primer - 2 Tubes  
<sup>b</sup> High Modulus Non-Conductive Urethane,Dam,Primer - 1.5 Tubes

**Clio 2 Door Hatchback (MEXICO Only) ..... 2006**

|                               |   |
|-------------------------------|---|
| <b>FW02290<sup>a b</sup></b>  | Windshield (Solar) (Mexico Only) ..... <b>28.9x58.4</b>   |
| <b>FD21504-05</b>             | Door F/R-L (Mexico Only) ..... <b>14.0x35.0</b>           |
| <b>FQ21506-07<sup>c</sup></b> | Quarter R-L (Mexico Only) ..... <b>10.0x13.0</b>          |
| <b>FB21508<sup>c</sup></b>    | Back Window (Heated) (Mexico Only) ..... <b>26.0x38.0</b> |

<sup>a</sup> Urethane,Dam,Primer - 2 Tubes  
<sup>b</sup> Fast-Cure Urethane/Dam/Primer - Quantity 2  
<sup>c</sup> Urethane,Dam,Primer - 1.5 Tubes

**Clio 4 Door Hatchback (MEXICO Only) ..... 2006-2009**

|                              |   |
|------------------------------|---|
| <b>FW02290<sup>a b</sup></b> | Windshield (Solar) (Mexico Only) ..... <b>28.9x58.4</b>   |
| <b>FD21504-05</b>            | Door F/R-L (Mexico Only) ..... <b>14.0x35.0</b>           |
| <b>FD22936-37</b>            | Door R/R-L (Mexico Only) ..... <b>18.0x23.0</b>           |
| <b>FV22938-39</b>            | Vent R/R-L (Mexico Only) ..... <b>8.0x 9.5</b>            |
| <b>FB22940<sup>c</sup></b>   | Back Window (Heated) (Mexico Only) ..... <b>26.0x38.0</b> |

<sup>a</sup> Urethane,Dam,Primer - 2 Tubes  
<sup>b</sup> Fast-Cure Urethane/Dam/Primer - Quantity 2  
<sup>c</sup> Urethane,Dam,Primer - 1.5 Tubes

|   |  |
|---|--|
| <p><b>Clio Euro 4 Door Hatchback (MEXICO Only).... 2007-2009</b></p> <p>FW03027<sup>a b</sup> Windshield (Solar) (Electrochromic Mirror, Mexico Only, Acoustic Interlayer) .....</p> <p>FW03026<sup>a b</sup> Windshield (Solar) (Mexico Only, Acoustic Interlayer, Rain Sensor) .....</p> <p>FW03025<sup>a b</sup> Windshield (Solar) (Electrochromic Mirror, Mexico Only) .....</p> <p>FW03024<sup>a b</sup> Windshield (Solar) (Mexico Only, Rain Sensor) .....</p> <p>FW03023<sup>a b</sup> Windshield (Solar) (Mexico Only) .....</p> <p>FD24088-89 Door F/R-L (2 Holes)(Solar) (Mexico Only) .....</p> <p>FD24090-91 Door R/R-L (1 Holes)(Solar) (Mexico Only) .....</p> <p>FV24092-93 Vent R/R-L (Solar) (Mexico Only) .....</p> <p>FB24094<sup>c</sup> Back Window (Heated)(Solar) (Mexico Only) .....</p> <p><sup>a</sup> Urethane,Dam,Primer - 2 Tubes<br/> <sup>b</sup> Fast-Cure Urethane/Dam/Primer - Quantity 2<br/> <sup>c</sup> Urethane,Dam,Primer - 1.5 Tubes</p> | <p><b>Laguna 4 Door Sedan (MEXICO Only)..... 2009-2010</b></p> <p>FW03237<sup>a b d</sup> Windshield (Mexico Only, Rain Sensor) .....</p> <p>FW03236<sup>a b</sup> Windshield (Mexico Only) .....</p> <p>FD24664-65 Door F/R-L (Mexico Only) .....</p> <p>FD24666-67 Door R/R-L (Mexico Only) .....</p> <p>FQ24668-69<sup>c</sup> Quarter R-L (Mexico Only) .....</p> <p>FB24671<sup>c</sup> Back Window (Ant)(Heated) (Mexico Only) .....</p> <p>FB24670<sup>c</sup> Back Window (Heated)(Solar) (Mexico Only) .....</p> <p><sup>a</sup> Urethane,Dam,Primer - 2 Tubes<br/> <sup>b</sup> Fast-Cure Urethane/Dam/Primer - Quantity 2<br/> <sup>c</sup> Urethane,Dam,Primer - 1.5 Tubes<br/> <sup>d</sup> Rain Sensor Kit</p>   |
| <p><b>Fluence 4 Door Sedan (MEXICO Only) ..... 2011</b></p> <p>FW03336<sup>a b d</sup> Windshield (Mexico Only, Rain Sensor) .....</p> <p>FW03335<sup>a b</sup> Windshield (Mexico Only) .....</p> <p>FD24887-88 Door F/R-L (Solar) (Mexico Only) .....</p> <p>FD24889-90 Door R/R-L (Solar) (Mexico Only) .....</p> <p>FV24891-92 Vent R/R-L (Solar) (Mexico Only) .....</p> <p>FB24893<sup>c</sup> Back Window (Ant)(Heated)(Solar) (Mexico Only) ...</p> <p><sup>a</sup> Urethane,Dam,Primer - 2 Tubes<br/> <sup>b</sup> Fast-Cure Urethane/Dam/Primer - Quantity 2<br/> <sup>c</sup> Urethane,Dam,Primer - 1.5 Tubes<br/> <sup>d</sup> Rain Sensor Kit</p>  | <p><b>Megane 4 Door Sedan (MEXICO Only) ..... 2006-2009</b></p> <p>FW03008<sup>a b</sup> Windshield (Solar) (Acoustic Interlayer, Export Only, Rain Sensor) ..... 35.3x55.8</p> <p>FW02104<sup>a b</sup> Windshield (Solar) (Mexico Only, Acoustic Interlayer) ..... 35.3x55.8</p> <p>FD21518-19 Door F/R-L (Mexico Only) .....</p> <p>FD21520-21 Door R/R-L (Mexico Only) .....</p> <p>FV21522-23 Vent R/R-L (Mexico Only) .....</p> <p>FB21524<sup>c</sup> Back Window (Mexico Only) .....</p> <p><sup>a</sup> Urethane,Dam,Primer - 2 Tubes<br/> <sup>b</sup> Fast-Cure Urethane/Dam/Primer - Quantity 2<br/> <sup>c</sup> Urethane,Dam,Primer - 1.5 Tubes</p>  |
| <p><b>Kangoo Mini Van (MEXICO Only)..... 2006-2010</b></p> <p>FW02714<sup>a b</sup> Windshield (Mexico Only) .....</p> <p>FD23298-99 Door F/R-L (Mexico Only) .....</p> <p>FB23678<sup>c</sup> Back Window L (Heated) (Mexico Only) .....</p> <p>FB23677<sup>c</sup> Back Window R (Mexico Only) .....</p> <p><sup>a</sup> Urethane,Dam,Primer - 2 Tubes<br/> <sup>b</sup> Fast-Cure Urethane/Dam/Primer - Quantity 2<br/> <sup>c</sup> Urethane,Dam,Primer - 1.5 Tubes</p>   | <p><b>Sandero 4 Door Hatchback (MEXICO Only)..... 2010</b></p> <p><b>Stepway 4 Door Hatchback (MEXICO Only) ..... 2010</b></p> <p>FW03238<sup>a b</sup> Windshield (W/Third Visor Frit, Mexico Only) .....</p> <p>FD24674-75 Door F/R-L (Mexico Only) .....</p> <p>FD24676-77 Door R/R-L (Mexico Only) .....</p> <p>FV24678-79 Vent R/R-L (Mexico Only) .....</p> <p>FB24680<sup>c</sup> Back Window (Heated)(1 Holes) (Mexico Only, W/ Wiper) .....</p> <p><sup>a</sup> Urethane,Dam,Primer - 2 Tubes<br/> <sup>b</sup> Fast-Cure Urethane/Dam/Primer - Quantity 2<br/> <sup>c</sup> Urethane,Dam,Primer - 1.5 Tubes</p>  |
| <p><b>Kangoo PASSENGER Mini Van (MEXICO Only) 2007-2010</b></p> <p>FW02714<sup>a b</sup> Windshield (Mexico Only) .....</p> <p>FD23298-99 Door F/R-L (Mexico Only) .....</p> <p>FD23672-73 Door R/R-L (Mexico Only) .....</p> <p>FD23673 Side L (Mexico Only) .....</p> <p>FQ23674-75 Quarter R-L (Mexico Only) .....</p> <p>FB23676<sup>c</sup> Back Window (Heated) (Mexico Only) .....</p> <p><sup>a</sup> Urethane,Dam,Primer - 2 Tubes<br/> <sup>b</sup> Fast-Cure Urethane/Dam/Primer - Quantity 2<br/> <sup>c</sup> Urethane,Dam,Primer - 1.5 Tubes</p>  | <p><b>Scenic 4 Door Hatchback (MEXICO Only) ..... 2010</b></p> <p>FW03330<sup>a b d</sup> Windshield (Solar) (Mexico Only, Acoustic Interlayer, Rain Sensor) .....</p> <p>FW03329<sup>a b</sup> Windshield (Solar) (Mexico Only, Acoustic Interlayer)</p> <p>FW03328<sup>a b d</sup> Windshield (Solar) (Mexico Only, Rain Sensor) .....</p> <p>FW03327<sup>a b</sup> Windshield (Solar) (Mexico Only) .....</p> <p>FD24845-46 Door F/R-L (Solar) (Mexico Only) .....</p> <p>FD24847-48 Door R/R-L (Solar) (Mexico Only) .....</p> <p>FQ24849-50<sup>c</sup> Quarter R-L (Encap)(Solar) (Mexico Only) .....</p> <p>FV24843-44 Vent F/R-L (Solar) (Mexico Only) .....</p> <p>FB24852<sup>c</sup> Back Window (Ant)(Heated)(1 Holes)(Solar) (Mexico Only) .....</p> <p>FB24851<sup>c</sup> Back Window (Heated)(1 Holes)(Solar) (Mexico Only)</p> <p><sup>a</sup> Urethane,Dam,Primer - 2 Tubes<br/> <sup>b</sup> Fast-Cure Urethane/Dam/Primer - Quantity 2<br/> <sup>c</sup> Urethane,Dam,Primer - 1.5 Tubes<br/> <sup>d</sup> Rain Sensor Kit</p> |
| <p><b>Koleos 4 Door Utility (MEXICO Only) ..... 2009-2010</b></p> <p>FW03022<sup>a b</sup> Windshield (Solar) (Mexico Only, Acoustic Interlayer, Rain Sensor) .....</p> <p>FW03021<sup>a b</sup> Windshield (Solar) (Mexico Only, Rain Sensor) .....</p> <p>FD24078-79 Door F/R-L (Solar) (Mexico Only) .....</p> <p>FD24080-81 Door R/R-L (Solar) (Mexico Only) .....</p> <p>FQ24084-85<sup>c</sup> Quarter R-L (Encap)(Solar) (Mexico Only) .....</p> <p>FV24082-83 Vent R/R-L (Solar) (Mexico Only) .....</p> <p>FB24087<sup>c</sup> Back Window (Ant)(Heated)(Solar) (Mexico Only) ...</p> <p>FB24086<sup>c</sup> Back Window (Heated)(Solar) (Mexico Only) .....</p> <p><sup>a</sup> Urethane,Dam,Primer - 2 Tubes<br/> <sup>b</sup> Fast-Cure Urethane/Dam/Primer - Quantity 2<br/> <sup>c</sup> Urethane,Dam,Primer - 1.5 Tubes</p>  | <p><b>Scenic 4 Door Hatchback (MEXICO Only) ..... 2006-2009</b></p> <p>FW03326<sup>a b d</sup> Windshield (Solar) (Mexico Only, Acoustic Interlayer, Rain Sensor) ..... 39.3x55.3</p>  |

| <i>Scenic</i>   | <i>(cont.)</i>   |
|---|------------------|
| <b>FW02103<sup>a b</sup></b> Windshield (Solar)(Mexico Only, Acoustic Interlayer) | <b>39.3x55.3</b> |
| <b>FD21511-12</b> Door F/R-L (Mexico Only)  | <b>20.3x24.0</b> |
| <b>FD21513-14</b> Door R/R-L (Mexico Only)  | <b>22.0x29.8</b> |
| <b>FQ21515-16<sup>c</sup></b> Quarter R-L (Mexico Only)                           | <b>13.5x25.0</b> |
| <b>FV21509-10</b> Vent F/R-L (Mexico Only)  | <b>15.0x18.0</b> |
| <b>FB21517<sup>c</sup></b> Back Window (Heated)(1 Holes)(Mexico Only)             | <b>23.5x49.5</b> |
| <sup>a</sup> Urethane,Dam,Primer - 2 Tubes  |                  |
| <sup>b</sup> Fast-Cure Urethane/Dam/Primer - Quantity 2                           |                  |
| <sup>c</sup> Urethane,Dam,Primer - 1.5 Tubes                                      |                  |
| <sup>d</sup> Rain Sensor Kit  |                  |
| <sup>e</sup> Urethane,Dam,Primer - 1 Tube   |                  |

**Traffic Van (MEXICO Only) ..... 2008-2010**

|   |  |
|---|--|
| <b>FW03038<sup>a b</sup></b> Windshield (Solar)(Mexico Only, Solar Coated, Rain Sensor) |  |
| <b>FW03037<sup>a b</sup></b> Windshield (Solar)(Mexico Only, Solar Coated)              |  |
| <b>FW03036<sup>a b</sup></b> Windshield (Solar)(Mexico Only, Rain Sensor)               |  |
| <b>FW02952<sup>a b</sup></b> Windshield (Solar)(Mexico Only)                            |  |
| <b>FD24116-17</b> Door F/R-L (Solar)(Mexico Only)                                       |  |
| <b>FD24118-19</b> Door R/R-L (Solar)(Mexico Only)                                       |  |
| <b>FQ24122-23<sup>c</sup></b> Quarter R-L (Encap)(Solar)(Mexico Only, Movable)          |  |
| <b>FQ24120-21<sup>c</sup></b> Quarter R-L (Solar)(Stationary, Mexico Only)              |  |
| <b>FV24114-15</b> Vent F/R-L (Solar)(Mexico Only)                                       |  |
| <b>FB24126-27<sup>c</sup></b> Back Window R-L (Heated)(Solar)(Mexico Only)              |  |
| <b>FB24124-25<sup>c</sup></b> Back Window R-L (Solar)(Mexico Only)                      |  |
| <sup>a</sup> Urethane,Dam,Primer - 2 Tubes  |  |
| <sup>b</sup> Fast-Cure Urethane/Dam/Primer - Quantity 2                                 |  |
| <sup>c</sup> Urethane,Dam,Primer - 1.5 Tubes  |  |

**Rover**

**MG ZR 2 Door Hatchback (MEXICO Only)..... 2006-2007**

|  |  |
|--|--|
| <b>FW03020<sup>a b</sup></b> Windshield (Mexico Only)        |  |
| <b>FB24077<sup>c</sup></b> Back Window (Heated)(Mexico Only) |  |
| <sup>a</sup> Urethane,Dam,Primer - 2 Tubes                   |  |
| <sup>b</sup> Fast-Cure Urethane/Dam/Primer - Quantity 2      |  |
| <sup>c</sup> Urethane,Dam,Primer - 1.5 Tubes                 |  |

**MG ZR 4 Door Hatchback (MEXICO Only)..... 2006-2007**

|  |  |
|--|--|
| <b>FW03020<sup>a b</sup></b> Windshield (Mexico Only)        |  |
| <b>FB24077<sup>c</sup></b> Back Window (Heated)(Mexico Only) |  |
| <sup>a</sup> Urethane,Dam,Primer - 2 Tubes                   |  |
| <sup>b</sup> Fast-Cure Urethane/Dam/Primer - Quantity 2      |  |
| <sup>c</sup> Urethane,Dam,Primer - 1.5 Tubes                 |  |

**Saab**

**9-2x 4 Door Station Wagon..... 2006-2007**

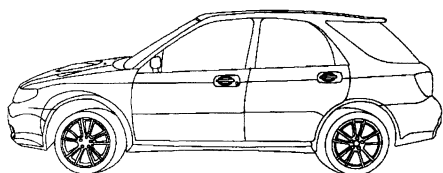

|  |                  |
|--|------------------|
| <b>FW02543<sup>a b</sup></b> Windshield (W/Third Visor Frit)             | <b>36.3x57.2</b> |
| <b>FW02425<sup>a b</sup></b> Windshield (Heated)(Heated Wiper Park Area) | <b>36.3x57.2</b> |
| <b>FD21448-49</b> Door F/R-L   | <b>21.0x31.5</b> |

| <i>9-2x</i>  | <i>(cont.)</i>   |
|--|------------------|
| <b>FD21450-51</b> Door R/R-L   | <b>21.0x29.0</b> |
| <b>FQ21431-32<sup>d</sup></b> Quarter R-L (Encap)                    | <b>15.0x21.5</b> |
| <b>FB22120<sup>c</sup></b> Back Window (Ant)(Encap)(Heated)(1 Holes) | <b>22.5x51.0</b> |
| <b>FB21433<sup>c</sup></b> Back Window (Encap)(Heated)(1 Holes)      | <b>22.5x51.0</b> |
| <sup>a</sup> Urethane,Dam,Primer - 2 Tubes                           |                  |
| <sup>b</sup> Fast-Cure Urethane/Dam/Primer - Quantity 2              |                  |
| <sup>c</sup> Urethane,Dam,Primer - 1.5 Tubes                         |                  |
| <sup>d</sup> Urethane,Dam,Primer - 1 Tube                            |                  |

**9-3 2 Door Convertible ..... 2006-2010**

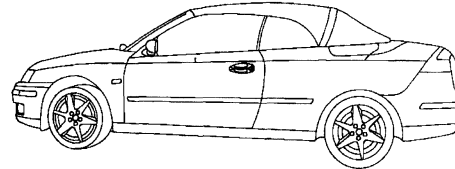

|   |                  |
|---|------------------|
| <b>FW02958<sup>a b</sup></b> Windshield (Solar)(Rain Sensor)(08-10) | <b>32.5x61.5</b> |
| <b>FW02957<sup>a b</sup></b> Windshield (Solar)(08-10)              | <b>32.5x61.5</b> |
| <b>FW02451<sup>a b</sup></b> Windshield (Solar)(Rain Sensor)(06-07) | <b>32.5x61.5</b> |
| <b>FW02450<sup>a b</sup></b> Windshield (Solar)(06-07)              | <b>32.5x61.5</b> |
| <b>FD22218-19</b> Door F/R-L (1 Holes)(Solar)                       | <b>18.5x38.0</b> |
| <b>FQ22220-21</b> Quarter R-L (Encap)(Solar)                        | <b>16.0x22.5</b> |
| <b>FB22222</b> Back Window (Heated)(Solar)                          | <b>16.0x38.0</b> |
| <sup>a</sup> Urethane,Dam,Primer - 2 Tubes                          |                  |
| <sup>b</sup> Fast-Cure Urethane/Dam/Primer - Quantity 2             |                  |

**9-3 4 Door Sedan ..... 2006-2010**

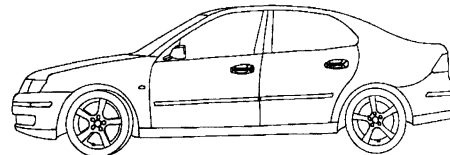

|  |                  |
|--|------------------|
| <b>FW02374<sup>a b</sup></b> Windshield (Solar)(Rain Sensor) | <b>38.1x59.3</b> |
| <b>FW02373<sup>a b</sup></b> Windshield (Solar)              | <b>38.1x59.3</b> |
| <b>FD21887-88</b> Door F/R-L (Solar)                         | <b>19.6x32.0</b> |
| <b>FD21889-90</b> Door R/R-L (Solar)                         | <b>18.5x22.5</b> |
| <b>FV21891-92</b> Vent R/R-L (Encap)(Solar)                  | <b>9.5x12.0</b>  |
| <b>FB21893<sup>c</sup></b> Back Window (Ant)(Heated)(Solar)  | <b>30.0x47.4</b> |
| <sup>a</sup> Urethane,Dam,Primer - 2 Tubes                   |                  |
| <sup>b</sup> Fast-Cure Urethane/Dam/Primer - Quantity 2      |                  |
| <sup>c</sup> Urethane,Dam,Primer - 1.5 Tubes                 |                  |

**9-3 4 Door Station Wagon ..... 2006-2010**

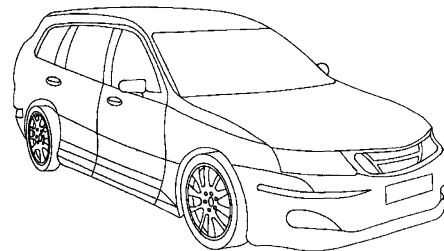

|  |                  |
|--|------------------|
| <b>FW02374<sup>a b</sup></b> Windshield (Solar)(Rain Sensor) | <b>38.1x59.3</b> |
| <b>FW02373<sup>a b</sup></b> Windshield (Solar)              | <b>38.1x59.3</b> |
| <b>FD21887-88</b> Door F/R-L (Solar)                         | <b>19.6x32.0</b> |

**9-3 (cont.)**

|   |           |
|---|-----------|
| FD22948-49 Door R/R-L (Solar) .....                             | 20.0x23.0 |
| FQ22952-53 <sup>d</sup> Quarter R-L (Ant)(Encap)(Solar) .....   | 15.0x21.0 |
| FV22950-51 Vent R/R-L (Encap)(Solar) .....                      | 10.0x15.0 |
| FB22954 <sup>c</sup> Back Window (Heated)(1 Holes)(Solar) ..... | 23.2x50.2 |

<sup>a</sup> Urethane,Dam,Primer - 2 Tubes  
<sup>b</sup> Fast-Cure Urethane/Dam/Primer - Quantity 2  
<sup>c</sup> Urethane,Dam,Primer - 1.5 Tubes  
<sup>d</sup> Urethane,Dam,Primer - 1 Tube

**9-5 4 Door Sedan ..... 2006-2009**

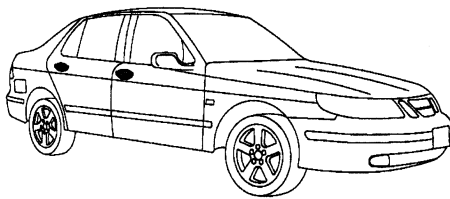

|   |           |
|---|-----------|
| FW02324 <sup>a</sup> Windshield (Solar) (Rain Sensor) ..... | 37.8x62.3 |
| FW02088 <sup>a</sup> Windshield (Solar) .....               | 37.8x62.3 |
| FD20432-33 Door F/R-L (Solar) .....                         | 22.0x35.0 |
| FD20434-35 Door R/R-L (Solar) .....                         | 22.4x23.2 |
| FV20436-37 <sup>b</sup> Vent R/R-L (Encap)(Solar) .....     | 11.0x15.0 |
| FB20438 <sup>a</sup> Back Window (Heated)(Solar) .....      | 30.7x50.8 |

<sup>a</sup> High Modulus Urethane,Dam,Primer - 2 Tubes  
<sup>b</sup> Encapsulation Lubricant

**9-5 4 Door Station Wagon..... 2006-2009**

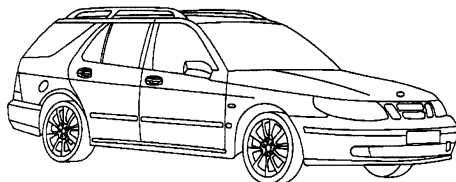

|   |           |
|---|-----------|
| FW02324 <sup>b</sup> Windshield (Solar) (Rain Sensor) .....     | 37.8x62.3 |
| FW02088 <sup>b</sup> Windshield (Solar) .....                   | 37.8x62.3 |
| FD20432-33 Door F/R-L (Solar) .....                             | 22.0x35.0 |
| FD20941-42 Door R/R-L (Solar) .....                             | 21.0x22.0 |
| FQ20945-46 <sup>c</sup> Quarter R-L (Ant)(Encap)(Solar) .....   | 13.5x40.0 |
| FV20943-44 Vent R/R-L (Encap)(Solar) .....                      | 11.0x16.0 |
| FB20947 <sup>a</sup> Back Window (Heated)(1 Holes)(Solar) ..... | 19.6x49.7 |

<sup>a</sup> High Modulus Urethane,Dam,Primer - 1.5 Tubes  
<sup>b</sup> High Modulus Urethane,Dam,Primer - 2 Tubes  
<sup>c</sup> High Modulus Urethane,Dam,Primer - 1 Tube

**9-7x 4 Door Utility ..... 2006-2009**

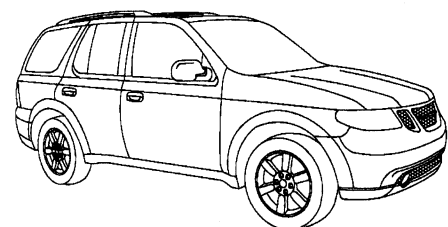

|  |           |
|--|-----------|
| DW01610 <sup>b c d</sup> Windshield (Solar) (W/Third Visor Frit, Acoustic Inter-layer) ..... | 33.4x59.6 |
|--|-----------|

**9-7x (cont.)**

|  |           |
|--|-----------|
| DW01584 <sup>a c d</sup> Windshield (Solar) (W/Third Visor Frit) ..... | 33.4x59.6 |
| DD10574-75 Door F/R-L (Solar) (Laminated) .....                        | 21.5x34.0 |
| DD09965-66 Door F/R-L (Solar) .....                                    | 21.5x34.0 |
| DD09967-68 Door R/R-L (Solar) .....                                    | 18.5x21.5 |
| DQ10929-30 <sup>e</sup> Quarter R-L (Ant)(Encap)(Solar) .....          | 19.0x35.0 |
| DV09971-72 Vent R/R-L (Encap)(Solar) .....                             | 10.5x20.0 |
| DB09983 Back Window (Heated)(Solar) (Movable) .....                    | 26.0x54.0 |
| DB09982 Back Window (Solar) (Movable) .....                            | 26.0x54.0 |

<sup>a</sup> Not On Production Vehicles  
<sup>b</sup> On Production Vehicles  
<sup>c</sup> Urethane,Dam,Primer - 2 Tubes  
<sup>d</sup> Fast-Cure Urethane/Dam/Primer - Quantity 2  
<sup>e</sup> Urethane,Dam,Primer - 1 Tube

**Saturn Astra 2 Door Hatchback ..... 2008-2009**

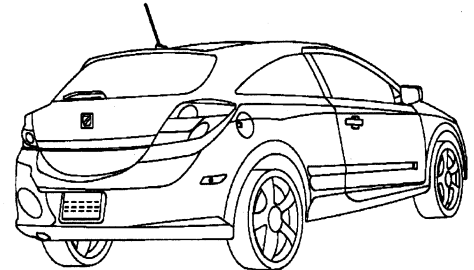

|   |           |
|---|-----------|
| DW01772 <sup>a b</sup> Windshield (Encap) (W/Third Visor Frit, Rain Sensor) ..... | 35.0x55.0 |
| DD11602-03 Door F/R-L .....   | 19.3x44.0 |
| DQ11604-05 <sup>d</sup> Quarter R-L (Encap) .....                                 | 14.0x37.0 |
| DB11606 <sup>c</sup> Back Window (Encap)(Heated)(1 Holes)(Solar) .....            | 21.0x59.0 |

<sup>a</sup> Urethane,Dam,Primer - 2 Tubes  
<sup>b</sup> Fast-Cure Urethane/Dam/Primer - Quantity 2  
<sup>c</sup> Urethane,Dam,Primer - 1.5 Tubes  
<sup>d</sup> Urethane,Dam,Primer - 1 Tube

**Saturn Astra 4 Door Hatchback ..... 2008-2009**

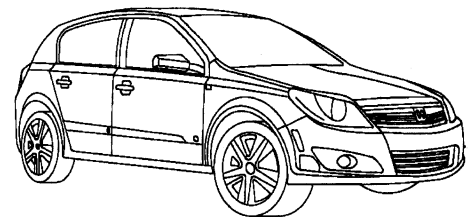

|   |           |
|---|-----------|
| DW01674 <sup>a b</sup> Windshield (Encap) (Rain Sensor) ..... | 35.0x55.0 |
| DD11243-44 Door F/R-L .....                                   | 19.3x37.0 |
| DD11245-46 Door R/R-L .....                                   | 21.3x26.0 |
| DV11247-48 Vent R/R-L .....                                   | 10.0x12.5 |
| DB11249 <sup>c</sup> Back Window (Encap)(Heated) .....        | 18.5x57.0 |

<sup>a</sup> Urethane,Dam,Primer - 2 Tubes  
<sup>b</sup> Fast-Cure Urethane/Dam/Primer - Quantity 2  
<sup>c</sup> Urethane,Dam,Primer - 1.5 Tubes

**Aura 4 Door Sedan..... 2007-2010**

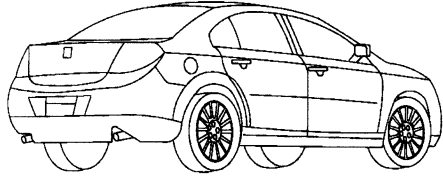

|  |                  |
|--|------------------|
| <b>DW01746<sup>a b d e</sup></b> Windshield (Solar) (W/Third Visor Frit) .....                             | <b>37.4x53.7</b> |
| <b>DW01672<sup>c d e</sup></b> Windshield (Solar) (W/Third Visor Frit, Acoustic Inter-layer) (07-08) ..... | <b>37.4x53.7</b> |
| <b>DD11236-37</b> Door F/R-L (Solar) (Laminated) .....   | <b>17.0x31.0</b> |
| <b>DD11238-39</b> Door R/R-L (Solar) .....   | <b>17.0x26.0</b> |
| <b>DV11240-41</b> Vent R/R-L (Solar) .....   | <b>9.3x12.0</b>  |
| <b>DB11242<sup>d</sup></b> Back Window (Heated)(Solar) .....   | <b>34.0x50.0</b> |

<sup>a</sup> Not On Production Vehicles 2007-2008  
<sup>b</sup> On Production Vehicles 2009-2010  
<sup>c</sup> On Production Vehicles 2007-2008  
<sup>d</sup> Urethane,Dam,Primer - 2 Tubes  
<sup>e</sup> Fast-Cure Urethane/Dam/Primer - Quantity 2

**L300 4 Door Sedan..... 2006**

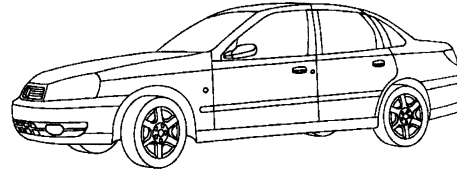

|   |                  |
|---|------------------|
| <b>DW01373<sup>a b</sup></b> Windshield (Mirror Button) .....     | <b>33.1x55.6</b> |
| <b>DD09597-98</b> Door F/R-L .....                                | <b>19.7x35.5</b> |
| <b>DD09600-01</b> Door R/R-L .....                                | <b>21.1x28.9</b> |
| <b>DQ09602-03<sup>d</sup></b> Quarter R-L (Encap) .....           | <b>11.8x18.7</b> |
| <b>DB10385<sup>c</sup></b> Back Window (Heated) (W/On-Star) ..... | <b>27.6x45.5</b> |
| <b>DB09604<sup>c</sup></b> Back Window (Heated) .....             | <b>27.6x45.5</b> |

<sup>a</sup> Urethane,Dam,Primer - 2 Tubes  
<sup>b</sup> Fast-Cure Urethane/Dam/Primer - Quantity 2  
<sup>c</sup> Urethane,Dam,Primer - 1.5 Tubes  
<sup>d</sup> Urethane,Dam,Primer - 1 Tube

**Ion 2 Door Coupe ..... 2006-2007**

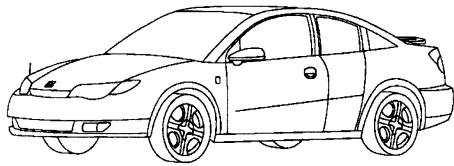

|  |                  |
|--|------------------|
| <b>DW01524<sup>a b</sup></b> Windshield .....                            | <b>38.5x60.7</b> |
| <b>DD10394-95</b> Door F/R-L (2 Holes)(Solar) .....                      | <b>18.6x37.9</b> |
| <b>DQ10396-97<sup>c</sup></b> Quarter R-L (Encap)(Solar) .....           | <b>14.3x21.7</b> |
| <b>DB11601<sup>a</sup></b> Back Window (Heated)(Solar) (W/On-Star) ..... | <b>32.6x49.4</b> |
| <b>DB10398<sup>a</sup></b> Back Window (Heated)(Solar) .....             | <b>32.6x49.4</b> |

<sup>a</sup> Urethane,Dam,Primer - 2 Tubes  
<sup>b</sup> Fast-Cure Urethane/Dam/Primer - Quantity 2  
<sup>c</sup> Urethane,Dam,Primer - 1 Tube

**Outlook 4 Door Utility ..... 2007-2010**

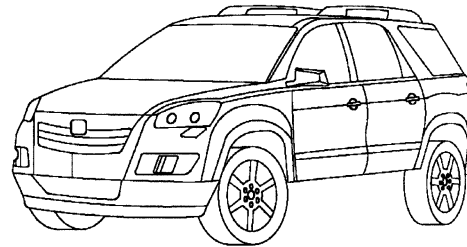

|  |                  |
|--|------------------|
| <b>DW01712<sup>a b</sup></b> Windshield (Solar) (W/Third Visor Frit) (08-10) ..... | <b>40.0x64.0</b> |
| <b>DW01679<sup>a b</sup></b> Windshield (Solar) (W/Third Visor Frit) (07) .....    | <b>40.0x64.0</b> |
| <b>DD11267-68</b> Door F/R-L (Solar) .....   | <b>27.5x33.5</b> |
| <b>DD11269-70</b> Door R/R-L (Solar) .....   | <b>24.0x29.5</b> |
| <b>DQ11271-72<sup>c</sup></b> Quarter R-L (Solar) .....                            | <b>17.0x40.0</b> |
| <b>DB11273<sup>c</sup></b> Back Window (Heated)(Solar) .....                       | <b>17.0x58.0</b> |

<sup>a</sup> Urethane,Dam,Primer - 2 Tubes  
<sup>b</sup> Fast-Cure Urethane/Dam/Primer - Quantity 2  
<sup>c</sup> Urethane,Dam,Primer - 1.5 Tubes

**Ion 4 Door Sedan..... 2006-2007**

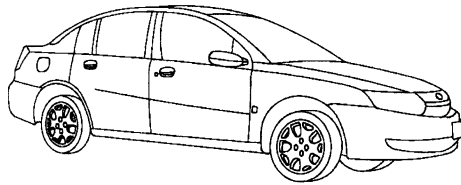

|  |                  |
|--|------------------|
| <b>DW01523<sup>a b</sup></b> Windshield .....                            | <b>37.2x57.9</b> |
| <b>DD10387-88</b> Door F/R-L (2 Holes)(Solar) .....                      | <b>22.5x35.5</b> |
| <b>DD10389-90</b> Door R/R-L (Solar) .....                               | <b>12.5x30.6</b> |
| <b>DV10391-92</b> Vent R/R-L (Encap)(Solar) .....                        | <b>8.4x13.2</b>  |
| <b>DB10445<sup>c</sup></b> Back Window (Heated)(Solar) (W/On-Star) ..... | <b>21.9x49.4</b> |
| <b>DB10393<sup>c</sup></b> Back Window (Heated)(Solar) .....             | <b>21.9x49.4</b> |

<sup>a</sup> Urethane,Dam,Primer - 2 Tubes  
<sup>b</sup> Fast-Cure Urethane/Dam/Primer - Quantity 2  
<sup>c</sup> Urethane,Dam,Primer - 1.5 Tubes

**Relay Mini Van ..... 2006-2007**

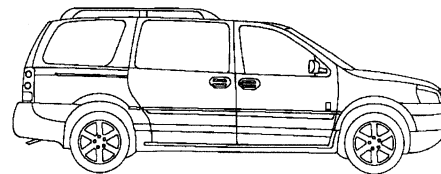

|   |                  |
|---|------------------|
| <b>DW01722<sup>a c d</sup></b> Windshield (Solar) (W/Third Visor Frit) (From 06/01/2007) (07) ..... | <b>48.2x62.1</b> |
| <b>DW01574<sup>a c d</sup></b> Windshield (Solar) (To 05/31/2007) .....                             | <b>48.2x62.1</b> |
| <b>DD10714-15</b> Door F/R-L (2 Holes)(Solar) .....   | <b>24.8x37.5</b> |
| <b>DD11029-30<sup>b</sup></b> Door R/R-L (Encap)(Solar) (Sliding Cargo Door) .....                  | <b>24.5x42.4</b> |
| <b>DD10997-98<sup>b</sup></b> Door R/R-L (Solar) (Sliding Cargo Door, Extended Van) .....           | <b>24.5x45.5</b> |
| <b>DQ10851-52</b> Quarter R-L (Encap)(Solar) .....  | <b>21.5x35.0</b> |
| <b>DQ10718-19</b> Quarter R-L (Encap)(1 Holes)(Solar) (Extended Van) .....                          | <b>21.5x35.0</b> |
| <b>DB10868<sup>b</sup></b> Back Window (Solar) .....  | <b>23.4x57.3</b> |
| <b>DB10720<sup>b</sup></b> Back Window (Heated)(1 Holes)(Solar) (W/Wiper) ...                       | <b>23.4x57.3</b> |

<sup>a</sup> May Require Two Person Installation  
<sup>b</sup> Urethane,Dam,Primer - 1.5 Tubes  
<sup>c</sup> Urethane,Dam,Primer - 2.5 Tubes

**Relay (cont.)**

<sup>d</sup> Fast-Cure Urethane/Dam/Primer - Quantity 2.5

**Sky 2 Door Convertible ..... 2007-2010**

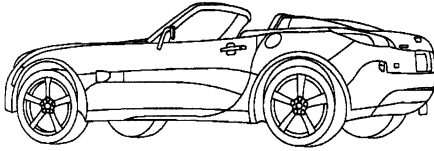

- DW01642<sup>a b</sup> Windshield (Solar) ..... 27.4x58.0
- DD11071-72 Door F/R-L (Solar) ..... 16.5x37.0
- DB11315 Back Window (Heated)(Solar) (Aftermarket Only) ....
- <sup>a</sup> Urethane,Dam,Primer - 2 Tubes
- <sup>b</sup> Fast-Cure Urethane/Dam/Primer - Quantity 2

**VUE 4 Door Utility ..... 2008-2010**

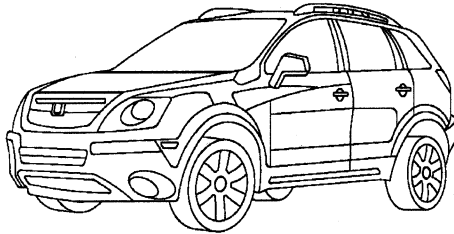

- DW01762<sup>a b c</sup> Windshield (Solar) (W/Third Visor Frit, Rain Sensor) (From 09/2007) ..... 38.5x56.5
- DW01761<sup>a b c</sup> Windshield (Solar) (W/Third Visor Frit) (From 09/2007) ..... 38.5x56.5
- DW01738<sup>a b c</sup> Windshield (Solar) (W/Third Visor Frit, Rain Sensor) (To 09/2007) (08) ..... 38.5x56.5
- DW01737<sup>a b c</sup> Windshield (Solar) (W/Third Visor Frit) (To 09/2007) (08) ..... 38.5x56.5
- DD11498-99 Door F/R-L (2 Holes)(Solar) ..... 27.3x37.0
- DD11500-01 Door R/R-L (2 Holes)(Solar) ..... 23.5x29.5
- DQ11502-03<sup>c</sup> Quarter R-L (Encap)(Solar) ..... 17.0x22.0
- DB11504<sup>d</sup> Back Window (Heated)(1 Holes)(Solar) (W/Wiper) ... 27.0x51.0
- <sup>a</sup> May Require Two Person Installation
- <sup>b</sup> Urethane,Dam,Primer - 2 Tubes
- <sup>c</sup> Fast-Cure Urethane/Dam/Primer - Quantity 2
- <sup>d</sup> Urethane,Dam,Primer - 1.5 Tubes
- <sup>e</sup> Urethane,Dam,Primer - 1 Tube

**VUE 4 Door Utility ..... 2006-2007**

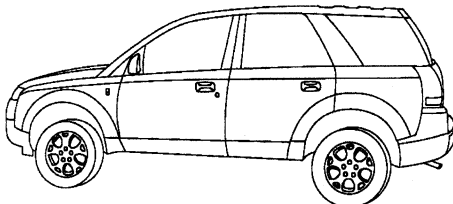

- DW01703<sup>a b c</sup> Windshield (Solar) (W/Third Visor Frit, Acoustic Inter-layer, Hybrid) (07) ..... 37.3x59.4
- DW01481<sup>a b c</sup> Windshield (Solar) (W/Third Visor Frit) ..... 37.3x59.4
- DD10138-39 Door F/R-L (Solar) ..... 20.5x32.8
- DD10136-37 Door F/R-L ..... 20.5x32.8

**VUE (cont.)**

- DD10142-43 Door R/R-L (Solar) ..... 19.5x20.5
- DD10140-41 Door R/R-L ..... 19.5x20.5
- DQ10150<sup>d</sup> Quarter L (Encap)(Solar) (W/On-Star) ..... 17.5x36.0
- DQ10148-49<sup>d</sup> Quarter R-L (Encap)(Solar) ..... 17.5x36.0
- DV10146-47 Vent R/R-L (Solar) ..... 11.2x17.5
- DV10144-45 Vent R/R-L ..... 11.2x17.5
- DB10151<sup>b</sup> Back Window (Heated)(1 Holes)(Solar) (W/Wiper) ... 35.0x55.0
- <sup>a</sup> May Require Two Person Installation
- <sup>b</sup> Urethane,Dam,Primer - 2 Tubes
- <sup>c</sup> Fast-Cure Urethane/Dam/Primer - Quantity 2
- <sup>d</sup> Urethane,Dam,Primer - 1 Tube

**Scion**

**TC 2 Door Coupe ..... 2011**

- FW03337<sup>a b</sup> Windshield (Solar) (W/Third Visor Frit) ..... 38.9x55.4
- FD24895-96 Door F/R-L (Solar) ..... 17.5x44.3
- FQ24897-98 Quarter R-L (Encap)(Solar) ..... 14.2x26.0
- FB24900 Back Window (Heated)(Solar) (W/Wiper) ..... 40.3x47.5
- FB24899 Back Window (Heated)(Solar) ..... 40.3x47.5
- <sup>a</sup> Urethane,Dam,Primer - 2 Tubes
- <sup>b</sup> Fast-Cure Urethane/Dam/Primer - Quantity 2

**TC 2 Door Coupe ..... 2006-2010**

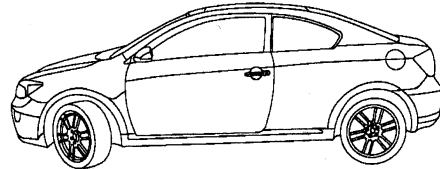

- FW02504<sup>a b</sup> Windshield (Solar) (W/Third Visor Frit) ..... 38.9x55.4
- FD22414-15 Door F/R-L (Solar) ..... 17.5x44.3
- FQ22416-17<sup>c</sup> Quarter R-L (Encap)(Solar) ..... 14.2x26.0
- FB22418<sup>a</sup> Back Window (Heated)(Solar) ..... 40.3x47.5
- <sup>a</sup> Urethane,Dam,Primer - 2 Tubes
- <sup>b</sup> Fast-Cure Urethane/Dam/Primer - Quantity 2
- <sup>c</sup> Urethane,Dam,Primer - 1 Tube

**XA 4 Door Hatchback ..... 2006-2007 (USA Only)**

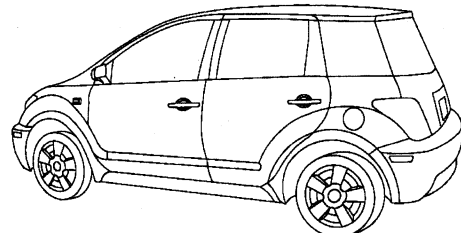

- FW02397<sup>a b</sup> Windshield ..... 36.0x51.0
- FD21985-86 Door F/R-L (Solar) ..... 20.0x33.0
- FD21987-88 Door R/R-L ..... 20.0x25.0
- FQ21989-90<sup>d</sup> Quarter R-L (Encap) ..... 15.7x18.5
- FB21991<sup>c</sup> Back Window (Heated) ..... 17.6x51.4
- <sup>a</sup> Urethane,Dam,Primer - 2 Tubes
- <sup>b</sup> Fast-Cure Urethane/Dam/Primer - Quantity 2
- <sup>c</sup> Urethane,Dam,Primer - 1.5 Tubes
- <sup>d</sup> Urethane,Dam,Primer - 1 Tube

**XB 4 Door Utility..... 2008-2011**

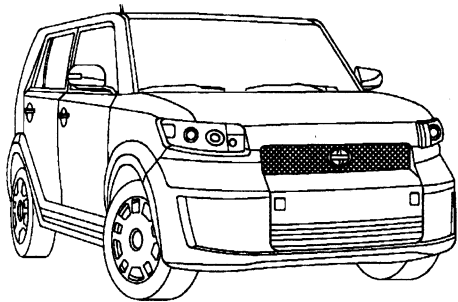

|  |                  |
|--|------------------|
| <b>FW02849<sup>a b</sup></b> Windshield (Solar) (W/Third Visor Frit) ..... | <b>28.5x57.0</b> |
| <b>FD23578-79</b> Door F/R-L (Solar) .....                                 | <b>19.0x36.8</b> |
| <b>FD23580-81</b> Door R/R-L (Solar) .....                                 | <b>19.0x28.0</b> |
| <b>FV23582-83</b> Vent R/R-L (Solar) .....                                 | <b>6.5x13.5</b>  |
| <b>FB23584<sup>c</sup></b> Back Window (Heated)(Solar) .....               | <b>17.0x60.5</b> |

<sup>a</sup> Urethane,Dam,Primer - 2 Tubes  
<sup>b</sup> Fast-Cure Urethane/Dam/Primer - Quantity 2  
<sup>c</sup> Urethane,Dam,Primer - 1.5 Tubes

**XB 4 Door Utility..... 2006-2007 (USA Only)**

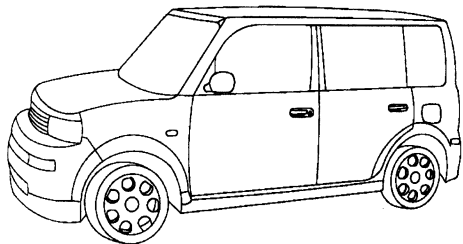

|  |                  |
|--|------------------|
| <b>FW02398<sup>a b</sup></b> Windshield (Solar) .....        | <b>26.7x58.5</b> |
| <b>FD21992-93</b> Door F/R-L (Solar) .....                   | <b>19.0x34.0</b> |
| <b>FD21994-95</b> Door R/R-L (Solar) .....                   | <b>19.3x22.3</b> |
| <b>FQ21998-99<sup>d</sup></b> Quarter R-L (Ant)(Solar) ..... | <b>16.8x19.0</b> |
| <b>FV21996-97</b> Vent R/R-L (Solar) .....                   | <b>8.9x18.2</b>  |
| <b>FB22000<sup>c</sup></b> Back Window (Heated)(Solar) ..... | <b>18.6x51.7</b> |

<sup>a</sup> Urethane,Dam,Primer - 2 Tubes  
<sup>b</sup> Fast-Cure Urethane/Dam/Primer - Quantity 2  
<sup>c</sup> Urethane,Dam,Primer - 1.5 Tubes  
<sup>d</sup> Urethane,Dam,Primer - 1 Tube

**XD 4 Door Hatchback..... 2008-2011**

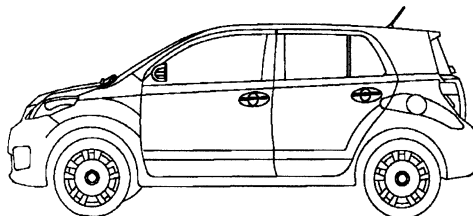

|  |                  |
|--|------------------|
| <b>FW02880<sup>a b</sup></b> Windshield (Solar) (W/Third Visor Frit) ..... | <b>32.5x51.5</b> |
| <b>FD23648-49</b> Door F/R-L (Solar) .....                                 | <b>20.5x34.5</b> |
| <b>FD23650-51</b> Door R/R-L (Solar) .....                                 | <b>19.5x21.5</b> |
| <b>FV23652-53<sup>d</sup></b> Vent R/R-L (Solar) .....                     | <b>11.5x13.5</b> |
| <b>FB23654<sup>c</sup></b> Back Window (Heated)(1 Holes)(Solar) .....      | <b>13.5x52.0</b> |

<sup>a</sup> Urethane,Dam,Primer - 2 Tubes

**XD (cont.)**

<sup>b</sup> Fast-Cure Urethane/Dam/Primer - Quantity 2  
<sup>c</sup> Urethane,Dam,Primer - 1.5 Tubes  
<sup>d</sup> Urethane,Dam,Primer - 1 Tube

**Alhambra Mini Van (MEXICO Only)..... 2006-2008**

|  |                  |
|--|------------------|
| <b>FW02330<sup>b</sup></b> Windshield (Mexico Only) .....                    | <b>40.0x55.0</b> |
| <b>FD21751-52</b> Door F/R-L (Mexico Only) .....                             | <b>27.0x34.0</b> |
| <b>FD21753-54</b> Door R/R-L (Mexico Only) .....                             |                  |
| <b>FQ21755-56</b> Quarter R-L (1 Holes) (Mexico Only, Movable) .....         | <b>22.0x34.5</b> |
| <b>FV21749-50<sup>c</sup></b> Vent F/R-L (Mexico Only) .....                 | <b>11.0x21.0</b> |
| <b>FB21757<sup>a</sup></b> Back Window (Heated)(1 Holes) (Mexico Only) ..... | <b>22.0x55.0</b> |

<sup>a</sup> High Modulus Urethane,Dam,Primer - 1.5 Tubes  
<sup>b</sup> High Modulus Urethane,Dam,Primer - 2 Tubes  
<sup>c</sup> High Modulus Urethane,Dam,Primer - 1 Tube

**Altea 4 Door Hatchback (MEXICO Only)..... 2006-2010**

|   |  |
|---|--|
| <b>FW03207<sup>a c</sup></b> Windshield (Encap)(Heated)(Solar) (Mexico Only, Rain Sensor) ..... |  |
| <b>FW03206<sup>a c</sup></b> Windshield (Encap)(Solar) (Mexico Only, Rain Sensor) .....         |  |
| <b>FW03205<sup>c</sup></b> Windshield (Encap)(Heated)(Solar) (Mexico Only) .....                |  |
| <b>FW03204<sup>c</sup></b> Windshield (Encap)(Solar) (Mexico Only) .....                        |  |
| <b>FD24579-80</b> Door F/R-L (Solar) (Mexico Only) .....  |  |
| <b>FD24581-82</b> Door R/R-L (Solar) (Mexico Only) .....  |  |
| <b>FQ24583-84<sup>b</sup></b> Quarter R-L (Encap)(Solar) (Mexico Only) .....                    |  |
| <b>FV24577-78</b> Vent F/R-L (Encap)(Solar) (Mexico Only) .....                                 |  |
| <b>FB24585<sup>b</sup></b> Back Window (Encap)(Heated)(Solar) (Mexico Only) .....               |  |

<sup>a</sup> Rain Sensor Kit  
<sup>b</sup> High Modulus Urethane,Dam,Primer - 1.5 Tubes  
<sup>c</sup> High Modulus Urethane,Dam,Primer - 2 Tubes

**Altea XL 4 Door Hatchback (MEXICO Only)..... 2007-2010**

|   |  |
|---|--|
| <b>FW03207<sup>a c</sup></b> Windshield (Encap)(Heated)(Solar) (Mexico Only, Rain Sensor) ..... |  |
| <b>FW03206<sup>a c</sup></b> Windshield (Encap)(Solar) (Mexico Only, Rain Sensor) .....         |  |
| <b>FW03205<sup>c</sup></b> Windshield (Encap)(Heated)(Solar) (Mexico Only) .....                |  |
| <b>FW03204<sup>c</sup></b> Windshield (Encap)(Solar) (Mexico Only) .....                        |  |
| <b>FD24579-80</b> Door F/R-L (Solar) (Mexico Only) .....  |  |
| <b>FD24581-82</b> Door R/R-L (Solar) (Mexico Only) .....  |  |
| <b>FQ24586-87<sup>b</sup></b> Quarter R-L (Encap)(Solar) (Mexico Only) .....                    |  |
| <b>FV24577-78</b> Vent F/R-L (Encap)(Solar) (Mexico Only) .....                                 |  |
| <b>FB24588<sup>b</sup></b> Back Window (Heated)(Solar) (Mexico Only) .....                      |  |

<sup>a</sup> Rain Sensor Kit  
<sup>b</sup> High Modulus Urethane,Dam,Primer - 1.5 Tubes  
<sup>c</sup> High Modulus Urethane,Dam,Primer - 2 Tubes

**Cordoba 4 Door Sedan (MEXICO Only)..... 2006-2007**

|  |  |
|--|--|
| <b>FW02709<sup>b</sup></b> Windshield (Mexico Only, Rain Sensor) ..... |  |
| <b>FW02708<sup>b</sup></b> Windshield (Mexico Only) .....              |  |
| <b>FD23278-79</b> Door F/R-L (Mexico Only) .....                       |  |
| <b>FD23280-81</b> Door R/R-L (Mexico Only) .....                       |  |
| <b>FQ23304-05<sup>a</sup></b> Quarter R-L (Mexico Only) .....          |  |
| <b>FB23282<sup>a</sup></b> Back Window (Heated) (Mexico Only) .....    |  |

<sup>a</sup> High Modulus Urethane,Dam,Primer - 1.5 Tubes  
<sup>b</sup> High Modulus Urethane,Dam,Primer - 2 Tubes



**Freetrack 4 Door Hatchback (MEXICO Only).... 2008-2010**

|                               |  |
|-------------------------------|--|
| <b>FW03207<sup>a c</sup></b>  | Windshield (Encap)(Heated)(Solar) (Mexico Only, Rain Sensor) ..... |
| <b>FW03206<sup>a c</sup></b>  | Windshield (Encap)(Solar) (Mexico Only, Rain Sensor) .....         |
| <b>FW03205<sup>c</sup></b>    | Windshield (Encap)(Heated)(Solar) (Mexico Only) .....              |
| <b>FW03204<sup>c</sup></b>    | Windshield (Encap)(Solar) (Mexico Only) .....                      |
| <b>FD24579-80</b>             | Door F/R-L (Solar) (Mexico Only) .....                             |
| <b>FD24581-82</b>             | Door R/R-L (Solar) (Mexico Only) .....                             |
| <b>FQ24586-87<sup>b</sup></b> | Quarter R-L (Encap)(Solar) (Mexico Only) .....                     |
| <b>FV24577-78</b>             | Vent F/R-L (Encap)(Solar) (Mexico Only) .....                      |
| <b>FB24588<sup>b</sup></b>    | Back Window (Heated)(Solar) (Mexico Only) .....                    |

<sup>a</sup> Rain Sensor Kit  
<sup>b</sup> High Modulus Urethane,Dam,Primer - 1.5 Tubes  
<sup>c</sup> High Modulus Urethane,Dam,Primer - 2 Tubes

**Ibiza 2 Door Hatchback (MEXICO Only)..... 2009-2010**

|                               |   |
|-------------------------------|---|
| <b>FW03121<sup>c</sup></b>    | Windshield (Solar) (Mexico Only, Rain Sensor) ..... |
| <b>FW03120<sup>a c</sup></b>  | Windshield (Solar) (Mexico Only) .....              |
| <b>FD24357-58</b>             | Door F/R-L (Solar) (Mexico Only) .....              |
| <b>FQ24359-60<sup>b</sup></b> | Quarter R-L (Encap)(Solar) (Mexico Only) .....      |
| <b>FB24361<sup>b</sup></b>    | Back Window (Heated)(1 Holes)(Solar) (Mexico Only)  |

<sup>a</sup> Mirror Button 8" from top  
<sup>b</sup> High Modulus Urethane,Dam,Primer - 1.5 Tubes  
<sup>c</sup> High Modulus Urethane,Dam,Primer - 2 Tubes

**Ibiza 2 Door Hatchback (MEXICO Only)..... 2006-2008**

|                               |   |
|-------------------------------|---|
| <b>FW02709<sup>b</sup></b>    | Windshield (Mexico Only, Rain Sensor) ..... |
| <b>FW02708<sup>b</sup></b>    | Windshield (Mexico Only) .....              |
| <b>FD23283-84</b>             | Door F/R-L (Mexico Only) .....              |
| <b>FQ23285-86<sup>a</sup></b> | Quarter R-L (Mexico Only) .....             |
| <b>FB23287<sup>a</sup></b>    | Back Window (Heated) (Mexico Only) .....    |

<sup>a</sup> High Modulus Urethane,Dam,Primer - 1.5 Tubes  
<sup>b</sup> High Modulus Urethane,Dam,Primer - 2 Tubes

**Ibiza 4 Door Hatchback (MEXICO Only)..... 2009-2010**

|                               |   |
|-------------------------------|---|
| <b>FW03122<sup>a c</sup></b>  | Windshield (Solar) (Mexico Only) .....              |
| <b>FW03121<sup>c</sup></b>    | Windshield (Solar) (Mexico Only, Rain Sensor) ..... |
| <b>FD24364-65</b>             | Door F/R-L (Solar) (Mexico Only) .....              |
| <b>FD24366-67</b>             | Door R/R-L (Solar) (Mexico Only) .....              |
| <b>FQ24368-69<sup>b</sup></b> | Quarter R-L (Encap)(Solar) (Mexico Only) .....      |
| <b>FV24362-63<sup>b</sup></b> | Vent F/R-L (Encap)(Solar) (Mexico Only) .....       |
| <b>FB24370<sup>b</sup></b>    | Back Window (Heated)(1 Holes)(Solar) (Mexico Only)  |

<sup>a</sup> Mirror Button 6.5" from top  
<sup>b</sup> High Modulus Urethane,Dam,Primer - 1.5 Tubes  
<sup>c</sup> High Modulus Urethane,Dam,Primer - 2 Tubes

**Ibiza 4 Door Hatchback (MEXICO Only)..... 2006-2008**

|                               |   |
|-------------------------------|---|
| <b>FW02709<sup>b</sup></b>    | Windshield (Mexico Only, Rain Sensor) ..... |
| <b>FW02708<sup>b</sup></b>    | Windshield (Mexico Only) .....              |
| <b>FD23278-79</b>             | Door F/R-L (Mexico Only) .....              |
| <b>FD23280-81</b>             | Door R/R-L (Mexico Only) .....              |
| <b>FQ23306-07<sup>a</sup></b> | Quarter R-L (Mexico Only) .....             |
| <b>FB23287<sup>a</sup></b>    | Back Window (Heated) (Mexico Only) .....    |

<sup>a</sup> High Modulus Urethane,Dam,Primer - 1.5 Tubes  
<sup>b</sup> High Modulus Urethane,Dam,Primer - 2 Tubes

**Leon 4 Door Hatchback (MEXICO Only)..... 2007-2010**

|                               |  |
|-------------------------------|--|
| <b>FW02919<sup>b</sup></b>    | Windshield (Heated)(Solar) (PAAS System, Mexico Only, Rain Sensor) ..... |
| <b>FW02918<sup>b</sup></b>    | Windshield (Solar) (PAAS System, Mexico Only, Rain Sensor) .....         |
| <b>FW02917<sup>b</sup></b>    | Windshield (Heated)(Solar) (PAAS System, Mexico Only) .....              |
| <b>FW02916<sup>b</sup></b>    | Windshield (Solar) (PAAS System, Mexico Only) .....                      |
| <b>FD23756-57</b>             | Door F/R-L (Solar) (Mexico Only) .....                                   |
| <b>FD23758-59</b>             | Door R/R-L (Solar) (Mexico Only) .....                                   |
| <b>FQ23760-61<sup>a</sup></b> | Quarter R-L (Encap)(Solar) (Mexico Only) .....                           |
| <b>FV23754-55<sup>a</sup></b> | Vent F/R-L (Encap)(Solar) (Mexico Only) .....                            |
| <b>FB23762<sup>a</sup></b>    | Back Window (Heated)(Solar) (PAAS System, Mexico Only) .....             |

<sup>a</sup> High Modulus Urethane,Dam,Primer - 1.5 Tubes  
<sup>b</sup> High Modulus Urethane,Dam,Primer - 2 Tubes

**Leon 4 Door Hatchback (MEXICO Only)..... 2006**

|                              |   |                  |
|------------------------------|---|------------------|
| <b>FW02846<sup>a c</sup></b> | Windshield (Encap) (Mexico Only, Rain Sensor) ..... | <b>34.5x54.0</b> |
| <b>FW02292<sup>c</sup></b>   | Windshield (Encap) (Mexico Only) .....              | <b>34.5x54.0</b> |
| <b>FD21555-56</b>            | Door F/R-L (Mexico Only) .....                      | <b>20.0x30.0</b> |
| <b>FD21557-58</b>            | Door R/R-L (Mexico Only) .....                      | <b>19.0x23.5</b> |
| <b>FV21559-60</b>            | Vent R/R-L (Encap) (Mexico Only) .....              | <b>11.0x13.5</b> |
| <b>FB21561<sup>b</sup></b>   | Back Window (Heated) (Mexico Only) .....            | <b>25.5x44.0</b> |

<sup>a</sup> Rain Sensor Kit  
<sup>b</sup> High Modulus Urethane,Dam,Primer - 1.5 Tubes  
<sup>c</sup> High Modulus Urethane,Dam,Primer - 2 Tubes

**Toledo 4 Door Hatchback (MEXICO Only)..... 2006-2008**

|                              |  |
|------------------------------|--|
| <b>FW03207<sup>a c</sup></b> | Windshield (Encap)(Heated)(Solar) (Mexico Only, Rain Sensor) .....             |
| <b>FW03206<sup>a c</sup></b> | Windshield (Encap)(Solar) (Mexico Only, Rain Sensor) .....                     |
| <b>FW03205<sup>c</sup></b>   | Windshield (Encap)(Heated)(Solar) (Mexico Only) .....                          |
| <b>FW03204<sup>c</sup></b>   | Windshield (Encap)(Solar) (Mexico Only) .....                                  |
| <b>FD24579-80</b>            | Door F/R-L (Solar) (Mexico Only) .....   |
| <b>FD24581-82</b>            | Door R/R-L (Solar) (Mexico Only) .....   |
| <b>FQ24583-84</b>            | Quarter R-L (Encap)(Solar) (Mexico Only) .....                                 |
| <b>FV24577-78</b>            | Vent F/R-L (Encap)(Solar) (Mexico Only) .....                                  |
| <b>FB24886<sup>b</sup></b>   | Back Window (Encap)(Heated)(Solar) (Mexico Only, High Mount Brake Light) ..... |

<sup>a</sup> Rain Sensor Kit  
<sup>b</sup> High Modulus Urethane,Dam,Primer - 1.5 Tubes  
<sup>c</sup> High Modulus Urethane,Dam,Primer - 2 Tubes

**Smart**

**Roadster 2 Door Convertible (MEXICO Only).... 2006**

|                              |                                |
|------------------------------|--------------------------------|
| <b>FW02689<sup>a b</sup></b> | Windshield (Mexico Only) ..... |
| <b>FD23217-18</b>            | Door F/R-L (Mexico Only) ..... |

<sup>a</sup> Urethane,Dam,Primer - 2 Tubes  
<sup>b</sup> Fast-Cure Urethane/Dam/Primer - Quantity 2

**Roadster 2 Door Coupe (MEXICO Only)..... 2006**

|                               |  |
|-------------------------------|--|
| <b>FW02689<sup>a b</sup></b>  | Windshield (Mexico Only) .....           |
| <b>FD23217-18</b>             | Door F/R-L (Mexico Only) .....           |
| <b>FQ23219-20<sup>c</sup></b> | Quarter R-L (Mexico Only) .....          |
| <b>FB23221<sup>c</sup></b>    | Back Window (Heated) (Mexico Only) ..... |

<sup>a</sup> Urethane,Dam,Primer - 2 Tubes  
<sup>b</sup> Fast-Cure Urethane/Dam/Primer - Quantity 2  
<sup>c</sup> Urethane,Dam,Primer - 1.5 Tubes

**fortfour 4 Door Hatchback (MEXICO Only)..... 2006**

- FW02690<sup>a b</sup> Windshield (Mexico Only) .....
- FD23222-23 Door F/R-L (Mexico Only) .....
- FD23224-25 Door R/R-L (Mexico Only) .....
- FV23226-27 Vent R/R-L (Mexico Only) .....
- FB23228<sup>c</sup> Back Window (Heated) (Mexico Only) .....

<sup>a</sup> Urethane,Dam,Primer - 2 Tubes  
<sup>b</sup> Fast-Cure Urethane/Dam/Primer - Quantity 2  
<sup>c</sup> Urethane,Dam,Primer - 1.5 Tubes

**fortwo 2 Door Convertible..... 2008-2011**

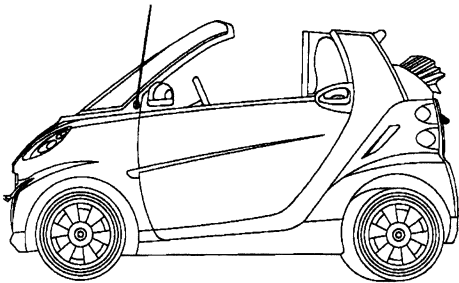

- FW02954<sup>a b</sup> Windshield (Solar) (W/Third Visor Frit, Rain Sensor) 35.7x47.7
- FW02953<sup>a b</sup> Windshield (Solar) (W/Third Visor Frit) ..... 35.7x47.7
- FD23923-24 Door F/R-L (2 Holes)(Solar) ..... 21.2x34.3
- FV23928-29 Vent F/R-L (Encap)(Solar) ..... 10.0x17.0
- FB23930 Back Window (Encap)(Heated)(Solar) ..... 10.5x33.5

<sup>a</sup> Urethane,Dam,Primer - 2 Tubes  
<sup>b</sup> Fast-Cure Urethane/Dam/Primer - Quantity 2

**fortwo 2 Door Convertible..... 2006-2007**

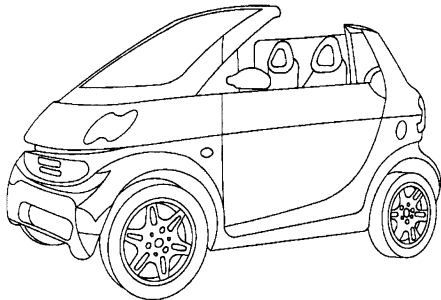

- FW02507<sup>a b</sup> Windshield .....
- FD22779-80 Door F/R-L .....
- FV22781-82 Vent F/R-L .....

<sup>a</sup> Urethane,Dam,Primer - 2 Tubes  
<sup>b</sup> Fast-Cure Urethane/Dam/Primer - Quantity 2

**fortwo 2 Door Coupe..... 2008-2011**

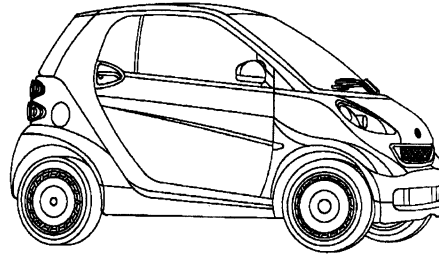

- FW02954<sup>a b</sup> Windshield (Solar) (W/Third Visor Frit, Rain Sensor) 35.7x47.7
- FW02953<sup>a b</sup> Windshield (Solar) (W/Third Visor Frit) ..... 35.7x47.7
- FD23923-24 Door F/R-L (2 Holes)(Solar) ..... 21.2x34.3
- FV23925-26 Vent F/R-L (Encap)(Solar) ..... 10.0x15.0
- FB23927 Back Window (Encap)(Heated)(Solar) ..... 15.5x50.5

<sup>a</sup> Urethane,Dam,Primer - 2 Tubes  
<sup>b</sup> Fast-Cure Urethane/Dam/Primer - Quantity 2

**fortwo 2 Door Coupe..... 2006-2007**

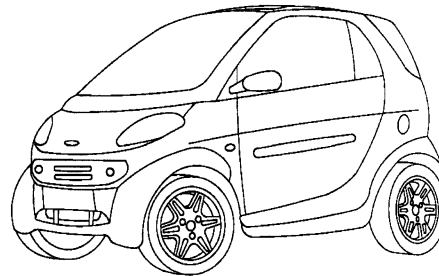

- FW02507<sup>a b</sup> Windshield .....
- FD22432-33 Door F/R-L .....
- FQ22436-37<sup>c</sup> Quarter R-L .....
- FV22434-35 Vent F/R-L (Encap) .....
- FB22438<sup>c</sup> Back Window (Heated)(1 Holes) .....

<sup>a</sup> Urethane,Dam,Primer - 2 Tubes  
<sup>b</sup> Fast-Cure Urethane/Dam/Primer - Quantity 2  
<sup>c</sup> Urethane,Dam,Primer - 1.5 Tubes

**Subaru**

**B9 Tribeca 4 Door Utility..... 2006-2007**

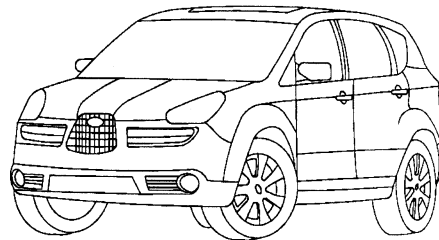

- FW02595<sup>a b c</sup> Windshield (Heated)(Solar) (Heated Wiper Park Area) 40.5x60.2
- FD22739-40 Door F/R-L (Solar) ..... 21.0x36.0
- FD22741-42 Door R/R-L (Solar) ..... 19.3x33.3
- FQ22743-44<sup>c</sup> Quarter R-L (Encap)(Solar) ..... 14.8x22.0
- FV22969-70<sup>c</sup> Vent F/R-L (Encap)(Solar) ..... 8.0x 9.0
- FB22745<sup>d</sup> Back Window (Heated)(1 Holes)(Solar) ..... 23.0x54.0

<sup>a</sup> Paint Band Slightly Narrowed in 2008

**B9 Tribeca (cont.)**

<sup>b</sup> Urethane,Dam,Primer - 2 Tubes  
<sup>c</sup> Fast-Cure Urethane/Dam/Primer - Quantity 2  
<sup>d</sup> Urethane,Dam,Primer - 1.5 Tubes  
<sup>e</sup> Urethane,Dam,Primer - 1 Tube

**Baja 4 Door Crew Cab ..... 2006-2007**

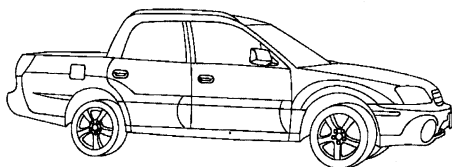

|  |                  |
|--|------------------|
| <b>FW02434<sup>a b</sup></b> Windshield .....                | <b>35.7x59.0</b> |
| <b>FD20839-40</b> Door F/R-L (6 Holes) .....                 | <b>22.8x33.5</b> |
| <b>FD21840-41</b> Door R/R-L (Solar) .....                   | <b>18.5x30.5</b> |
| <b>FB21842<sup>c</sup></b> Back Window (Heated)(Solar) ..... | <b>13.7x49.5</b> |

<sup>a</sup> Urethane,Dam,Primer - 2 Tubes  
<sup>b</sup> Fast-Cure Urethane/Dam/Primer - Quantity 2  
<sup>c</sup> Urethane,Dam,Primer - 1.5 Tubes

**Forester 4 Door Utility ..... 2009-2011**

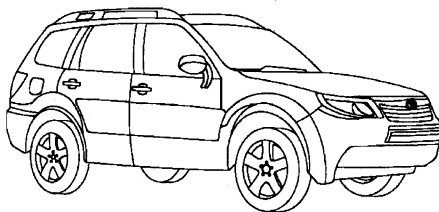

|   |                  |
|---|------------------|
| <b>FW02986<sup>a b</sup></b> Windshield (Heated) (Heated Wiper Park Area) ..... | <b>34.0x59.0</b> |
| <b>FW02985<sup>a b</sup></b> Windshield .....                                   | <b>34.0x59.0</b> |
| <b>FD23981-82</b> Door F/R-L .....  | <b>20.0x33.0</b> |
| <b>FD23983-84</b> Door R/R-L (Solar) .....                                      | <b>20.0x28.0</b> |
| <b>FQ23985-86<sup>d</sup></b> Quarter R-L (Solar) .....                         | <b>18.0x25.0</b> |
| <b>FB23987<sup>c</sup></b> Back Window (Heated)(1 Holes)(Solar) (W/Wiper) ...   | <b>20.0x50.0</b> |

<sup>a</sup> Urethane,Dam,Primer - 2 Tubes  
<sup>b</sup> Fast-Cure Urethane/Dam/Primer - Quantity 2  
<sup>c</sup> Urethane,Dam,Primer - 1.5 Tubes  
<sup>d</sup> Urethane,Dam,Primer - 1 Tube

**Forester 4 Door Utility ..... 2006-2008**

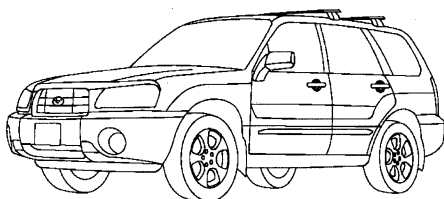

|   |                  |
|---|------------------|
| <b>FW02334<sup>a b</sup></b> Windshield (Heated) (Heated Wiper Park Area) ..... | <b>32.0x60.0</b> |
| <b>FW02333<sup>a b</sup></b> Windshield .....                                   | <b>32.0x60.0</b> |
| <b>FD21759-60</b> Door F/R-L .....  | <b>20.5x31.5</b> |
| <b>FD21761-62</b> Door R/R-L .....  | <b>20.5x29.0</b> |
| <b>FQ21764<sup>d</sup></b> Quarter L (Ant) .....                                | <b>17.3x25.5</b> |
| <b>FQ21763<sup>d</sup></b> Quarter R .....                                      | <b>17.3x25.5</b> |
| <b>FB23111<sup>c</sup></b> Back Window (Heated)(1 Holes) .....                  | <b>20.0x48.0</b> |

<sup>a</sup> Urethane,Dam,Primer - 2 Tubes

**Forester (cont.)**

<sup>b</sup> Fast-Cure Urethane/Dam/Primer - Quantity 2  
<sup>c</sup> Urethane,Dam,Primer - 1.5 Tubes  
<sup>d</sup> Urethane,Dam,Primer - 1 Tube

**Impreza 4 Door Hatchback ..... 2008-2011**

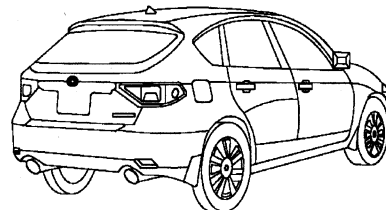

|   |                  |
|---|------------------|
| <b>FW02864<sup>a b</sup></b> Windshield (Heated) (W/Third Visor Frit, Heated Wiper Park Area) ..... | <b>35.5x55.0</b> |
| <b>FW02863<sup>a b</sup></b> Windshield (W/Third Visor Frit) .....                                  | <b>35.5x55.0</b> |
| <b>FD23603-04</b> Door F/R-L .....  | <b>21.5x35.0</b> |
| <b>FD23605-06</b> Door R/R-L .....  | <b>18.0x26.0</b> |
| <b>FQ23610-11<sup>d</sup></b> Quarter R-L (Encap) .....   | <b>15.5x16.5</b> |
| <b>FB23612<sup>c</sup></b> Back Window (Heated)(1 Holes) .....                                      | <b>23.0x49.0</b> |

<sup>a</sup> Urethane,Dam,Primer - 2 Tubes  
<sup>b</sup> Fast-Cure Urethane/Dam/Primer - Quantity 2  
<sup>c</sup> Urethane,Dam,Primer - 1.5 Tubes  
<sup>d</sup> Urethane,Dam,Primer - 1 Tube

**Impreza 4 Door Sedan ..... 2008-2011**

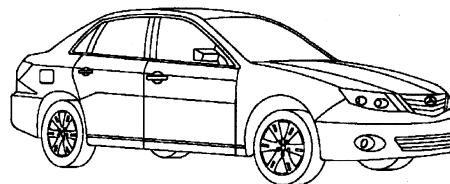

|   |                  |
|---|------------------|
| <b>FW02864<sup>a b</sup></b> Windshield (Heated) (W/Third Visor Frit, Heated Wiper Park Area) ..... | <b>35.5x55.0</b> |
| <b>FW02863<sup>a b</sup></b> Windshield (W/Third Visor Frit) .....                                  | <b>35.5x55.0</b> |
| <b>FD23603-04</b> Door F/R-L .....  | <b>21.5x35.0</b> |
| <b>FD23605-06</b> Door R/R-L .....  | <b>18.0x26.0</b> |
| <b>FQ23607-08<sup>d</sup></b> Quarter R-L (Encap) .....   | <b>9.0x15.5</b>  |
| <b>FB23609<sup>c</sup></b> Back Window (Heated)(Solar) .....  | <b>27.8x48.8</b> |

<sup>a</sup> Urethane,Dam,Primer - 2 Tubes  
<sup>b</sup> Fast-Cure Urethane/Dam/Primer - Quantity 2  
<sup>c</sup> Urethane,Dam,Primer - 1.5 Tubes  
<sup>d</sup> Urethane,Dam,Primer - 1 Tube

**Impreza 4 Door Sedan ..... 2006-2007**

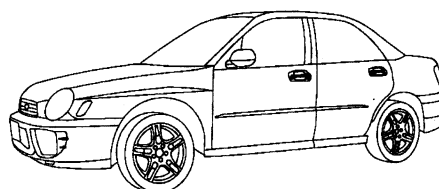

|   |                  |
|---|------------------|
| <b>FW02542<sup>a b</sup></b> Windshield (W/Third Visor Frit) .....                                  | <b>35.0x58.0</b> |
| <b>FW02424<sup>a b</sup></b> Windshield (Heated) (W/Third Visor Frit, Heated Wiper Park Area) ..... | <b>35.0x58.0</b> |
| <b>FD21351-52</b> Door F/R-L (8 Holes)(Solar) .....   | <b>24.0x35.0</b> |

**Impreza (cont.)**

|  |                  |
|--|------------------|
| <b>FD21353-54</b> Door R/R-L (6 Holes)(Solar) .....        | <b>23.5x31.0</b> |
| <b>FB22119<sup>c</sup></b> Back Window (Ant)(Heated) ..... | <b>28.0x51.5</b> |
| <sup>a</sup> Urethane,Dam,Primer - 2 Tubes                 |                  |
| <sup>b</sup> Fast-Cure Urethane/Dam/Primer - Quantity 2    |                  |
| <sup>c</sup> Urethane,Dam,Primer - 1.5 Tubes               |                  |

**Impreza STI 4 Door Sedan..... 2006-2007**

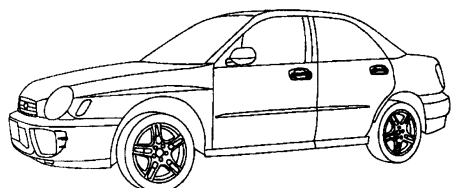

|   |                  |
|---|------------------|
| <b>FW02542<sup>a b</sup></b> Windshield (W/Third Visor Frit) .....                                  | <b>35.0x58.0</b> |
| <b>FW02424<sup>a b</sup></b> Windshield (Heated) (W/Third Visor Frit, Heated Wiper Park Area) ..... | <b>35.0x58.0</b> |
| <b>FD21351-52</b> Door F/R-L (8 Holes)(Solar) .....   | <b>24.0x35.0</b> |
| <b>FD21353-54</b> Door R/R-L (6 Holes)(Solar) .....   | <b>23.5x31.0</b> |
| <b>FB22137<sup>c</sup></b> Back Window (Ant)(Heated) .....  | <b>28.0x51.5</b> |
| <sup>a</sup> Urethane,Dam,Primer - 2 Tubes  |                  |
| <sup>b</sup> Fast-Cure Urethane/Dam/Primer - Quantity 2   |                  |
| <sup>c</sup> Urethane,Dam,Primer - 1.5 Tubes  |                  |

**Impreza 4 Door Station Wagon..... 2006-2007**

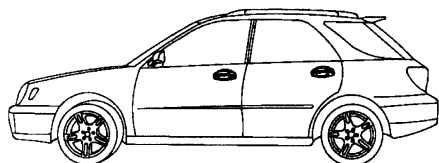

|   |                  |
|---|------------------|
| <b>FW02543<sup>a b</sup></b> Windshield (W/Third Visor Frit) .....              | <b>36.3x57.2</b> |
| <b>FW02425<sup>a b</sup></b> Windshield (Heated) (Heated Wiper Park Area) ..... | <b>36.3x57.2</b> |
| <b>FD21448-49</b> Door F/R-L .....  | <b>21.0x31.5</b> |
| <b>FD21450-51</b> Door R/R-L .....  | <b>21.0x29.0</b> |
| <b>FQ21431-32<sup>d</sup></b> Quarter R-L (Encap) .....                         | <b>15.0x21.5</b> |
| <b>FB22120<sup>c</sup></b> Back Window (Ant)(Encap)(Heated)(1 Holes) .....      | <b>22.5x51.0</b> |
| <sup>a</sup> Urethane,Dam,Primer - 2 Tubes                                      |                  |
| <sup>b</sup> Fast-Cure Urethane/Dam/Primer - Quantity 2                         |                  |
| <sup>c</sup> Urethane,Dam,Primer - 1.5 Tubes                                    |                  |
| <sup>d</sup> Urethane,Dam,Primer - 1 Tube                                       |                  |

**Legacy 4 Door Sedan..... 2010-2011**

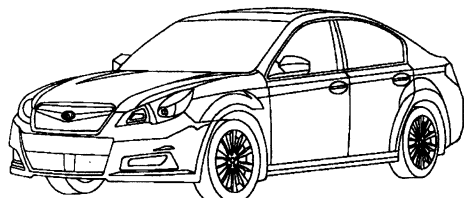

|   |                  |
|---|------------------|
| <b>FW03102<sup>a b</sup></b> Windshield (Heated) (W/Third Visor Frit, Heated Wiper Park Area) ..... | <b>36.0x57.5</b> |
| <b>FW03101<sup>a b</sup></b> Windshield (W/Third Visor Frit) .....                                  | <b>36.0x57.5</b> |
| <b>FD24291-92</b> Door F/R-L .....  | <b>19.0x34.0</b> |
| <b>FD24293-94</b> Door R/R-L (Solar) .....  | <b>19.0x25.5</b> |
| <b>FV24295-96</b> Vent R/R-L (Solar) .....  | <b>11.0x12.0</b> |
| <b>FB24297<sup>c</sup></b> Back Window (Ant)(Heated)(Solar) .....                                   | <b>30.0x51.0</b> |

**Legacy (cont.)**

|   |
|---|
| <sup>a</sup> Urethane,Dam,Primer - 2 Tubes              |
| <sup>b</sup> Fast-Cure Urethane/Dam/Primer - Quantity 2 |
| <sup>c</sup> Urethane,Dam,Primer - 1.5 Tubes            |

**Legacy 4 Door Sedan..... 2006-2009**

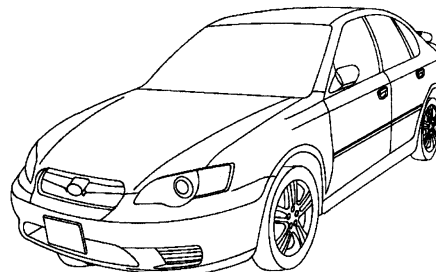

|   |                  |
|---|------------------|
| <b>FW02490<sup>a b</sup></b> Windshield (Heated) (Heated Wiper Park Area) ..... | <b>36.0x57.0</b> |
| <b>FW02489<sup>a b</sup></b> Windshield .....                                   | <b>36.0x57.0</b> |
| <b>FD22357-58</b> Door F/R-L (Solar) .....                                      | <b>22.3x34.1</b> |
| <b>FD22359-60</b> Door R/R-L (Solar) .....                                      | <b>23.2x29.6</b> |
| <b>FQ22361-62<sup>c</sup></b> Quarter R-L (Solar) .....                         | <b>13.9x15.7</b> |
| <b>FB22363<sup>a</sup></b> Back Window (Ant)(Heated)(Solar) .....               | <b>31.0x50.3</b> |
| <sup>a</sup> Urethane,Dam,Primer - 2 Tubes                                      |                  |
| <sup>b</sup> Fast-Cure Urethane/Dam/Primer - Quantity 2                         |                  |
| <sup>c</sup> Urethane,Dam,Primer - 1 Tube                                       |                  |

**Legacy 4 Door Station Wagon..... 2008-2009 (CANADA Only)**

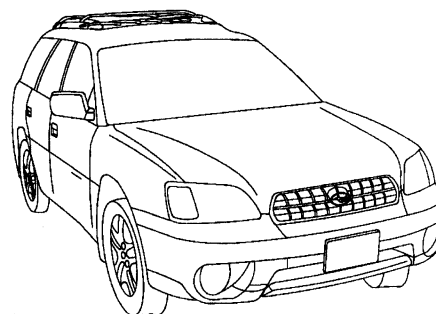

|   |                  |
|---|------------------|
| <b>FW02490<sup>a b</sup></b> Windshield (Heated) (Heated Wiper Park Area) ..... | <b>36.0x57.0</b> |
| <b>FW02489<sup>a b</sup></b> Windshield .....                                   | <b>36.0x57.0</b> |
| <b>FD22357-58</b> Door F/R-L (Solar) .....                                      | <b>22.3x34.1</b> |
| <b>FD22364-65</b> Door R/R-L (Solar) .....                                      | <b>23.2x29.6</b> |
| <b>FQ22368-69<sup>d</sup></b> Quarter R-L (Encap) .....                         | <b>15.0x38.2</b> |
| <b>FQ22366-67<sup>d</sup></b> Quarter R-L (Encap)(Solar) .....                  | <b>15.0x38.2</b> |
| <b>FB22371<sup>c</sup></b> Back Window (Encap)(Heated)(1 Holes) .....           | <b>19.0x55.5</b> |
| <b>FB22370<sup>c</sup></b> Back Window (Encap)(Heated)(1 Holes)(Solar) .....    | <b>19.0x55.5</b> |
| <sup>a</sup> Urethane,Dam,Primer - 2 Tubes                                      |                  |
| <sup>b</sup> Fast-Cure Urethane/Dam/Primer - Quantity 2                         |                  |
| <sup>c</sup> Urethane,Dam,Primer - 1.5 Tubes                                    |                  |
| <sup>d</sup> Urethane,Dam,Primer - 1 Tube                                       |                  |

**Legacy 4 Door Station Wagon..... 2006-2007**

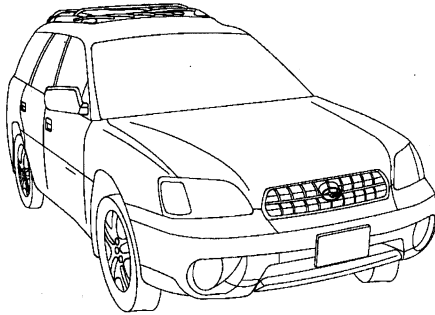

|                               |  |                  |
|-------------------------------|--|------------------|
| <b>FW02490<sup>a b</sup></b>  | Windshield (Heated) (Heated Wiper Park Area) ..... | <b>36.0x57.0</b> |
| <b>FW02489<sup>a b</sup></b>  | Windshield .....                                   | <b>36.0x57.0</b> |
| <b>FD22357-58</b>             | Door F/R-L (Solar) .....                           | <b>22.3x34.1</b> |
| <b>FD22364-65</b>             | Door R/R-L (Solar) .....                           | <b>23.2x29.6</b> |
| <b>FQ22368-69<sup>d</sup></b> | Quarter R-L (Encap) .....                          | <b>15.0x38.2</b> |
| <b>FQ22366-67<sup>d</sup></b> | Quarter R-L (Encap)(Solar) .....                   | <b>15.0x38.2</b> |
| <b>FB22371<sup>c</sup></b>    | Back Window (Encap)(Heated)(1 Holes) .....         | <b>19.0x55.5</b> |
| <b>FB22370<sup>c</sup></b>    | Back Window (Encap)(Heated)(1 Holes)(Solar) .....  | <b>19.0x55.5</b> |
| <sup>a</sup>                  | Urethane,Dam,Primer - 2 Tubes                      |                  |
| <sup>b</sup>                  | Fast-Cure Urethane/Dam/Primer - Quantity 2         |                  |
| <sup>c</sup>                  | Urethane,Dam,Primer - 1.5 Tubes                    |                  |
| <sup>d</sup>                  | Urethane,Dam,Primer - 1 Tube                       |                  |

**Outback 4 Door Sedan..... 2006-2007**

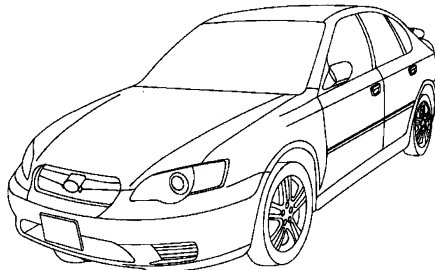

|                               |  |                  |
|-------------------------------|--|------------------|
| <b>FW02490<sup>a b</sup></b>  | Windshield (Heated) (Heated Wiper Park Area) ..... | <b>36.0x57.0</b> |
| <b>FW02489<sup>a b</sup></b>  | Windshield .....                                   | <b>36.0x57.0</b> |
| <b>FD22357-58</b>             | Door F/R-L (Solar) .....                           | <b>22.3x34.1</b> |
| <b>FD22359-60</b>             | Door R/R-L (Solar) .....                           | <b>23.2x29.6</b> |
| <b>FQ22361-62<sup>c</sup></b> | Quarter R-L (Solar) .....                          | <b>13.9x15.7</b> |
| <b>FB22363<sup>a</sup></b>    | Back Window (Ant)(Heated)(Solar) .....             | <b>31.0x50.3</b> |
| <sup>a</sup>                  | Urethane,Dam,Primer - 2 Tubes                      |                  |
| <sup>b</sup>                  | Fast-Cure Urethane/Dam/Primer - Quantity 2         |                  |
| <sup>c</sup>                  | Urethane,Dam,Primer - 1 Tube                       |                  |

**Outback 4 Door Station Wagon..... 2010-2011**

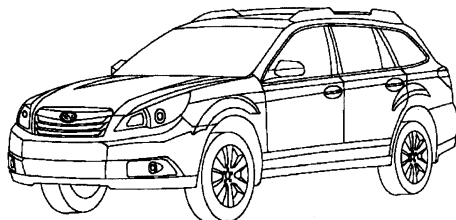

|                              |  |                  |
|------------------------------|--|------------------|
| <b>FW03102<sup>a b</sup></b> | Windshield (Heated) (W/Third Visor Frit, Heated Wiper Park Area) ..... | <b>36.0x57.5</b> |
| <b>FW03101<sup>a b</sup></b> | Windshield (W/Third Visor Frit) .....                                  | <b>36.0x57.5</b> |

**Outback (cont.)**

|                               |   |                  |
|-------------------------------|---|------------------|
| <b>FD24291-92</b>             | Door F/R-L .....  | <b>19.0x34.0</b> |
| <b>FD24298-99</b>             | Door R/R-L (Solar) .....                                  | <b>19.0x25.0</b> |
| <b>FQ24302-03<sup>d</sup></b> | Quarter R-L (Ant)(Encap)(Solar) .....                     | <b>15.0x23.0</b> |
| <b>FV24300-01</b>             | Vent R/R-L (Solar) .....                                  | <b>8.5x14.5</b>  |
| <b>FB24304<sup>c</sup></b>    | Back Window (Ant)(Heated)(1 Holes)(Solar) (W/Wiper) ..... | <b>19.0x54.5</b> |
| <sup>a</sup>                  | Urethane,Dam,Primer - 2 Tubes                             |                  |
| <sup>b</sup>                  | Fast-Cure Urethane/Dam/Primer - Quantity 2                |                  |
| <sup>c</sup>                  | Urethane,Dam,Primer - 1.5 Tubes                           |                  |
| <sup>d</sup>                  | Urethane,Dam,Primer - 1 Tube                              |                  |

**Outback 4 Door Station Wagon..... 2006-2009**

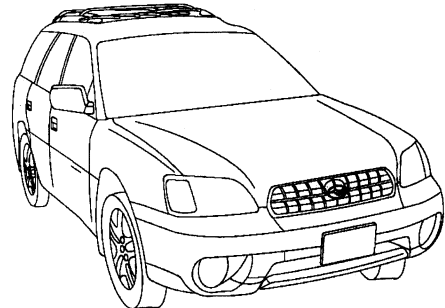

|                               |  |                  |
|-------------------------------|--|------------------|
| <b>FW02490<sup>a b</sup></b>  | Windshield (Heated) (Heated Wiper Park Area) ..... | <b>36.0x57.0</b> |
| <b>FW02489<sup>a b</sup></b>  | Windshield .....                                   | <b>36.0x57.0</b> |
| <b>FD22357-58</b>             | Door F/R-L (Solar) .....                           | <b>22.3x34.1</b> |
| <b>FD22364-65</b>             | Door R/R-L (Solar) .....                           | <b>23.2x29.6</b> |
| <b>FQ22368-69<sup>d</sup></b> | Quarter R-L (Encap) .....                          | <b>15.0x38.2</b> |
| <b>FQ22366-67<sup>d</sup></b> | Quarter R-L (Encap)(Solar) .....                   | <b>15.0x38.2</b> |
| <b>FB22371<sup>c</sup></b>    | Back Window (Encap)(Heated)(1 Holes) .....         | <b>19.0x55.5</b> |
| <b>FB22370<sup>c</sup></b>    | Back Window (Encap)(Heated)(1 Holes)(Solar) .....  | <b>19.0x55.5</b> |
| <sup>a</sup>                  | Urethane,Dam,Primer - 2 Tubes                      |                  |
| <sup>b</sup>                  | Fast-Cure Urethane/Dam/Primer - Quantity 2         |                  |
| <sup>c</sup>                  | Urethane,Dam,Primer - 1.5 Tubes                    |                  |
| <sup>d</sup>                  | Urethane,Dam,Primer - 1 Tube                       |                  |

**Outback SPORT 4 Door Station Wagon..... 2006-2007**

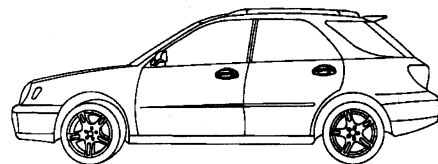

|                               |  |                  |
|-------------------------------|--|------------------|
| <b>FW02543<sup>a b</sup></b>  | Windshield (W/Third Visor Frit) .....              | <b>36.3x57.2</b> |
| <b>FW02425<sup>a b</sup></b>  | Windshield (Heated) (Heated Wiper Park Area) ..... | <b>36.3x57.2</b> |
| <b>FD21448-49</b>             | Door F/R-L .....                                   | <b>21.0x31.5</b> |
| <b>FD21450-51</b>             | Door R/R-L .....                                   | <b>21.0x29.0</b> |
| <b>FQ21431-32<sup>d</sup></b> | Quarter R-L (Encap) .....                          | <b>15.0x21.5</b> |
| <b>FB22120<sup>c</sup></b>    | Back Window (Ant)(Encap)(Heated)(1 Holes) .....    | <b>22.5x51.0</b> |
| <sup>a</sup>                  | Urethane,Dam,Primer - 2 Tubes                      |                  |
| <sup>b</sup>                  | Fast-Cure Urethane/Dam/Primer - Quantity 2         |                  |
| <sup>c</sup>                  | Urethane,Dam,Primer - 1.5 Tubes                    |                  |
| <sup>d</sup>                  | Urethane,Dam,Primer - 1 Tube                       |                  |

**Tribeca 4 Door Utility ..... 2008-2011**

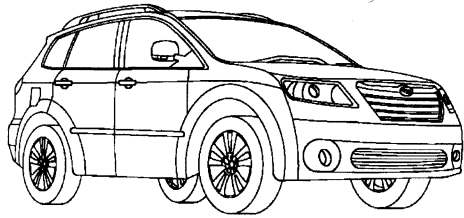

|  |                  |
|--|------------------|
| <b>FW02595<sup>a b c</sup></b> Windshield (Heated)(Solar) (Heated Wiper Park Area) | <b>40.5x60.2</b> |
| <b>FD22739-40</b> Door F/R-L (Solar)   | <b>21.0x36.0</b> |
| <b>FD22741-42</b> Door R/R-L (Solar)   | <b>19.3x33.3</b> |
| <b>FQ23813-14<sup>e</sup></b> Quarter R-L (Encap)(Solar)                           | <b>16.0x24.0</b> |
| <b>FV22969-70<sup>e</sup></b> Vent F/R-L (Encap)(Solar)                            | <b>8.0x 9.0</b>  |
| <b>FB23815<sup>d</sup></b> Back Window (Heated)(1 Holes)(Solar)                    | <b>21.0x51.0</b> |

<sup>a</sup> Paint Band Slightly Narrowed in 2008  
<sup>b</sup> Urethane,Dam,Primer - 2 Tubes  
<sup>c</sup> Fast-Cure Urethane/Dam/Primer - Quantity 2  
<sup>d</sup> Urethane,Dam,Primer - 1.5 Tubes  
<sup>e</sup> Urethane,Dam,Primer - 1 Tube

**Suzuki**

**Aerio SX 4 Door Hatchback ..... 2006**

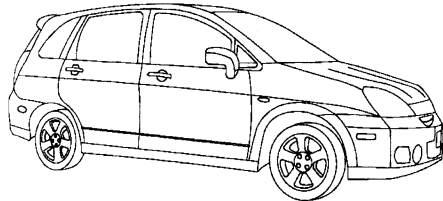

|  |                  |
|--|------------------|
| <b>FW02697<sup>a b</sup></b> Windshield                  | <b>34.5x55.0</b> |
| <b>FD21614-15</b> Door F/R-L                             | <b>20.0x31.0</b> |
| <b>FD21619-20</b> Door R/R-L                             | <b>19.0x29.2</b> |
| <b>FQ21621-22<sup>d</sup></b> Quarter R-L (Encap)        | <b>17.0x18.0</b> |
| <b>FV21612-13<sup>d</sup></b> Vent F/R-L (Encap)         | <b>8.0x 9.5</b>  |
| <b>FB21623<sup>c</sup></b> Back Window (Heated)(1 Holes) | <b>19.5x47.3</b> |

<sup>a</sup> Urethane,Dam,Primer - 2 Tubes  
<sup>b</sup> Fast-Cure Urethane/Dam/Primer - Quantity 2  
<sup>c</sup> Urethane,Dam,Primer - 1.5 Tubes  
<sup>d</sup> Urethane,Dam,Primer - 1 Tube

**Aerio 4 Door Sedan ..... 2006-2007**

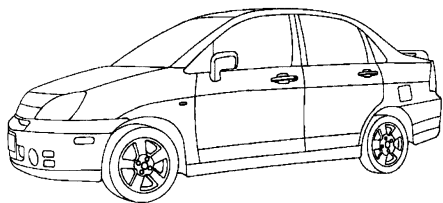

|  |                  |
|--|------------------|
| <b>FW02697<sup>a b</sup></b> Windshield              | <b>34.5x55.0</b> |
| <b>FD21614-15</b> Door F/R-L                         | <b>20.0x31.0</b> |
| <b>FD21616-17</b> Door R/R-L                         | <b>20.0x28.5</b> |
| <b>FV21612-13<sup>d</sup></b> Vent F/R-L (Encap)     | <b>8.0x 9.5</b>  |
| <b>FB21618<sup>c</sup></b> Back Window (Ant)(Heated) | <b>28.0x50.5</b> |

<sup>a</sup> Urethane,Dam,Primer - 2 Tubes  
<sup>b</sup> Fast-Cure Urethane/Dam/Primer - Quantity 2  
<sup>c</sup> Urethane,Dam,Primer - 1.5 Tubes

**Aerio (cont.)**

<sup>d</sup> Urethane,Dam,Primer - 1 Tube

**Equator 2 Door Extended Cab ..... 2009-2010**

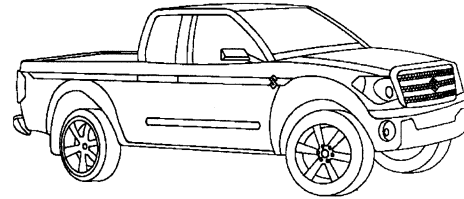

|  |                  |
|--|------------------|
| <b>FW02510<sup>a b</sup></b> Windshield (Solar)  | <b>33.1x60.2</b> |
| <b>FD22456-57</b> Door F/R-L (Solar)   | <b>23.5x32.6</b> |
| <b>FQ22476-77<sup>d</sup></b> Quarter R-L (Solar)  | <b>14.5x20.0</b> |
| <b>FY95052<sup>c</sup></b> Back Window (Encap)(Slider)(Solar) (Black Frame, Aftermarket, Power, 3 Panel Encapsulated)  | <b>16.0x58.0</b> |
| <b>FY95051<sup>c</sup></b> Back Window (Encap)(Slider)(Solar) (Black Frame, Aftermarket, Manual, 3 Panel Encapsulated) | <b>16.0x58.0</b> |
| <b>FB22821<sup>c</sup></b> Back Window (Solar) (Stationary)  | <b>16.0x58.0</b> |
| <b>FB22603<sup>c</sup></b> Back Window (Slider)(Solar) (OE)  | <b>16.0x58.0</b> |
| <b>FB22478<sup>c</sup></b> Back Window (Heated)(Solar) (Stationary)  | <b>16.0x58.0</b> |

<sup>a</sup> Urethane,Dam,Primer - 2 Tubes  
<sup>b</sup> Fast-Cure Urethane/Dam/Primer - Quantity 2  
<sup>c</sup> Urethane,Dam,Primer - 1.5 Tubes  
<sup>d</sup> Urethane,Dam,Primer - 1 Tube

**Equator 4 Door Crew Cab ..... 2009-2010**

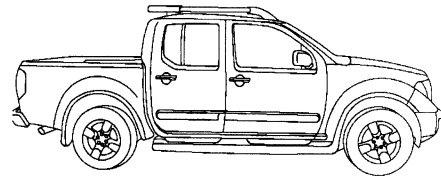

|  |                  |
|--|------------------|
| <b>FW02510<sup>a b</sup></b> Windshield (Solar)  | <b>33.1x60.2</b> |
| <b>FD22456-57</b> Door F/R-L (Solar)   | <b>23.5x32.6</b> |
| <b>FD22458-59</b> Door R/R-L (Solar)   | <b>16.7x22.6</b> |
| <b>FV22460-61</b> Vent R/R-L (Solar)   | <b>8.0x19.5</b>  |
| <b>FY95052<sup>c</sup></b> Back Window (Encap)(Slider)(Solar) (Black Frame, Aftermarket, Power, 3 Panel Encapsulated)  | <b>16.0x58.0</b> |
| <b>FY95051<sup>c</sup></b> Back Window (Encap)(Slider)(Solar) (Black Frame, Aftermarket, Manual, 3 Panel Encapsulated) | <b>16.0x58.0</b> |
| <b>FB22821<sup>c</sup></b> Back Window (Solar) (Stationary)  | <b>16.0x58.0</b> |
| <b>FB22603<sup>c</sup></b> Back Window (Slider)(Solar) (OE)  | <b>16.0x58.0</b> |
| <b>FB22478<sup>c</sup></b> Back Window (Heated)(Solar) (Stationary)  | <b>16.0x58.0</b> |

<sup>a</sup> Urethane,Dam,Primer - 2 Tubes  
<sup>b</sup> Fast-Cure Urethane/Dam/Primer - Quantity 2  
<sup>c</sup> Urethane,Dam,Primer - 1.5 Tubes

**Forenza 4 Door Sedan..... 2006-2008**  
(USA Only)

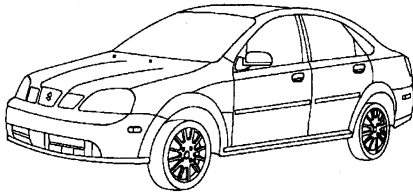

|   |                  |
|---|------------------|
| <b>FW02459<sup>a b</sup></b> Windshield .....           | <b>34.0x54.5</b> |
| <b>FD22264-65</b> Door F/R-L .....                      | <b>17.0x30.0</b> |
| <b>FD22266-67</b> Door R/R-L .....                      | <b>17.0x26.5</b> |
| <b>FQ22268-69<sup>d</sup></b> Quarter R-L (Encap) ..... | <b>8.5x20.5</b>  |
| <b>FB22270<sup>c</sup></b> Back Window (Heated) .....   | <b>28.0x49.0</b> |
| <sup>a</sup> Urethane,Dam,Primer - 2 Tubes              |                  |
| <sup>b</sup> Fast-Cure Urethane/Dam/Primer - Quantity 2 |                  |
| <sup>c</sup> Urethane,Dam,Primer - 1.5 Tubes            |                  |
| <sup>d</sup> Urethane,Dam,Primer - 1 Tube               |                  |

**Forenza 4 Door Station Wagon..... 2006-2008**  
(USA Only)

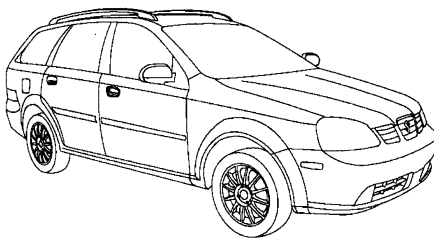

|   |                  |
|---|------------------|
| <b>DW01614<sup>a b d</sup></b> Windshield (Ant) (Rain Sensor) ..... | <b>34.0x54.5</b> |
| <b>DW01608<sup>a b</sup></b> Windshield (Ant) .....                 | <b>34.0x54.5</b> |
| <b>DD10656-57</b> Door F/R-L .....                                  | <b>17.0x30.0</b> |
| <b>DD10844-45</b> Door R/R-L .....                                  | <b>18.0x28.0</b> |
| <b>DR10867</b> Roof (Solar) .....                                   |                  |
| <b>DQ10846-47<sup>c</sup></b> Quarter R-L .....                     | <b>16.5x31.0</b> |
| <b>DB10848<sup>c</sup></b> Back Window (Ant)(Heated) .....          | <b>18.5x47.5</b> |
| <sup>a</sup> Urethane,Dam,Primer - 2 Tubes                          |                  |
| <sup>b</sup> Fast-Cure Urethane/Dam/Primer - Quantity 2             |                  |
| <sup>c</sup> Urethane,Dam,Primer - 1.5 Tubes                        |                  |
| <sup>d</sup> Rain Sensor Kit  |                  |
| <sup>e</sup> Urethane,Dam,Primer - 1 Tube                           |                  |

**Grand Vitara 4 Door Utility..... 2006-2011**

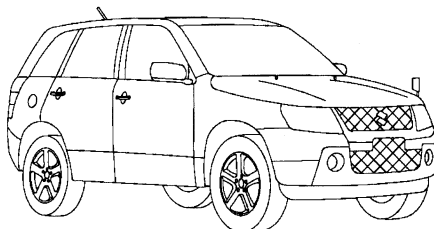

|  |                  |
|--|------------------|
| <b>FW02610<sup>a b</sup></b> Windshield (W/Third Visor Frit) ..... | <b>32.9x57.5</b> |
| <b>FD22857-58</b> Door F/R-L .....                                 | <b>23.0x35.8</b> |
| <b>FD22859-60</b> Door R/R-L (Solar) .....                         | <b>21.0x22.5</b> |
| <b>FQ22863-64<sup>d</sup></b> Quarter R-L (Encap)(Solar) .....     | <b>17.5x25.3</b> |
| <b>FV22861-62</b> Vent R/R-L (Solar) .....                         | <b>11.8x17.3</b> |

**Grand Vitara (cont.)**

|   |                  |
|---|------------------|
| <b>FB22865<sup>c</sup></b> Back Window (Heated)(1 Holes)(Solar) ..... | <b>18.0x49.5</b> |
| <sup>a</sup> Urethane,Dam,Primer - 2 Tubes                            |                  |
| <sup>b</sup> Fast-Cure Urethane/Dam/Primer - Quantity 2               |                  |
| <sup>c</sup> Urethane,Dam,Primer - 1.5 Tubes                          |                  |
| <sup>d</sup> Urethane,Dam,Primer - 1 Tube                             |                  |

**Kizashi 4 Door Sedan..... 2010-2011**

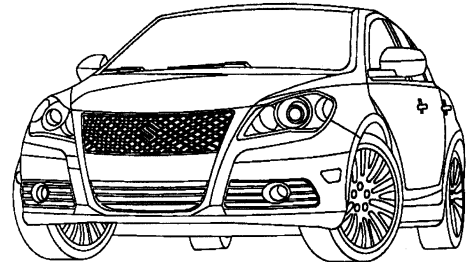

|   |                  |
|---|------------------|
| <b>FW03232<sup>a b d</sup></b> Windshield (W/Third Visor Frit, Rain Sensor) ..... | <b>38.0x57.0</b> |
| <b>FW03231<sup>a b</sup></b> Windshield (W/Third Visor Frit) .....                | <b>38.0x57.0</b> |
| <b>FD24644-45</b> Door F/R-L .....  | <b>17.0x34.0</b> |
| <b>FD24646-47</b> Door R/R-L .....  | <b>17.0x20.0</b> |
| <b>FV24648-49</b> Vent R/R-L .....  | <b>11.0x12.0</b> |
| <b>FB24650<sup>c</sup></b> Back Window (Ant)(Heated) .....                        | <b>28.0x49.0</b> |
| <sup>a</sup> Urethane,Dam,Primer - 2 Tubes  |                  |
| <sup>b</sup> Fast-Cure Urethane/Dam/Primer - Quantity 2                           |                  |
| <sup>c</sup> Urethane,Dam,Primer - 1.5 Tubes                                      |                  |
| <sup>d</sup> Rain Sensor Kit  |                  |

**Reno 4 Door Hatchback..... 2006-2008**  
(USA Only)

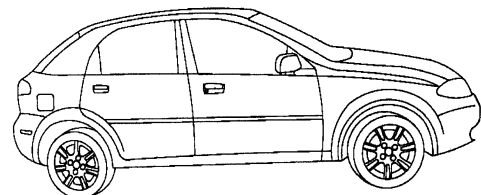

|   |                  |
|---|------------------|
| <b>DW01614<sup>a b d</sup></b> Windshield (Ant) (Rain Sensor) ..... | <b>34.0x54.5</b> |
| <b>DW01608<sup>a b</sup></b> Windshield (Ant) .....                 | <b>34.0x54.5</b> |
| <b>DD10656-57</b> Door F/R-L .....                                  | <b>17.0x30.0</b> |
| <b>DD10755-56</b> Door R/R-L .....                                  | <b>18.0x28.0</b> |
| <b>DR10867</b> Roof (Solar) .....                                   |                  |
| <b>DB11575<sup>c</sup></b> Back Window (Heated) .....               | <b>22.0x59.0</b> |
| <sup>a</sup> Urethane,Dam,Primer - 2 Tubes                          |                  |
| <sup>b</sup> Fast-Cure Urethane/Dam/Primer - Quantity 2             |                  |
| <sup>c</sup> Urethane,Dam,Primer - 1.5 Tubes                        |                  |
| <sup>d</sup> Rain Sensor Kit  |                  |

**SX4 4 Door Hatchback ..... 2007-2011**

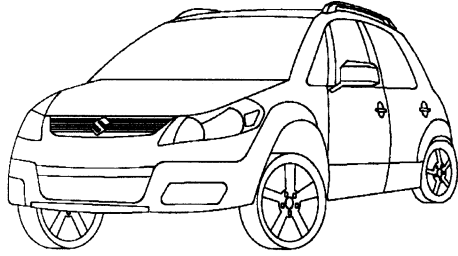

|   |                  |
|---|------------------|
| <b>FW03059<sup>a b</sup></b> Windshield (VIN Notch, W/Third Visor Frit) (09-11) . | <b>38.0x55.0</b> |
| <b>FW02726<sup>a b</sup></b> Windshield (W/Third Visor Frit) (07-08) .....        | <b>38.0x55.0</b> |
| <b>FD23351-52</b> Door F/R-L .....  | <b>23.0x31.3</b> |
| <b>FD23353-54</b> Door R/R-L .....  | <b>21.0x28.0</b> |
| <b>FQ23355-56<sup>d</sup></b> Quarter R-L (Encap) .....                           | <b>14.0x17.5</b> |
| <b>FV23349-50</b> Vent F/R-L (Encap) .....  | <b>12.0x24.0</b> |
| <b>FB23357<sup>c</sup></b> Back Window (Heated)(1 Holes) .....                    | <b>18.0x46.0</b> |
| <sup>a</sup> Urethane,Dam,Primer - 2 Tubes  |                  |
| <sup>b</sup> Fast-Cure Urethane/Dam/Primer - Quantity 2                           |                  |
| <sup>c</sup> Urethane,Dam,Primer - 1.5 Tubes                                      |                  |
| <sup>d</sup> Urethane,Dam,Primer - 1 Tube   |                  |

**SX4 4 Door Sedan..... 2008-2011**

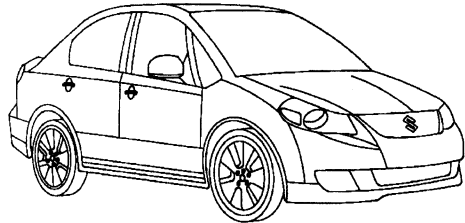

|   |                  |
|---|------------------|
| <b>FW03059<sup>a b</sup></b> Windshield (VIN Notch, W/Third Visor Frit) (09-11) . | <b>38.0x55.0</b> |
| <b>FW02726<sup>a b</sup></b> Windshield (W/Third Visor Frit) (08) .....           | <b>38.0x55.0</b> |
| <b>FD23351-52</b> Door F/R-L .....  | <b>23.0x31.3</b> |
| <b>FD23873-74</b> Door R/R-L .....  | <b>20.0x24.0</b> |
| <b>FV23349-50</b> Vent F/R-L (Encap) .....  | <b>12.0x24.0</b> |
| <b>FV23875-76</b> Vent R/R-L .....  | <b>7.5x12.5</b>  |
| <b>FB23877<sup>c</sup></b> Back Window (Heated) .....                             | <b>27.5x45.0</b> |
| <sup>a</sup> Urethane,Dam,Primer - 2 Tubes  |                  |
| <sup>b</sup> Fast-Cure Urethane/Dam/Primer - Quantity 2                           |                  |
| <sup>c</sup> Urethane,Dam,Primer - 1.5 Tubes                                      |                  |

**Swift 4 Door Hatchback ..... 2009-2011 (CANADA Only)**

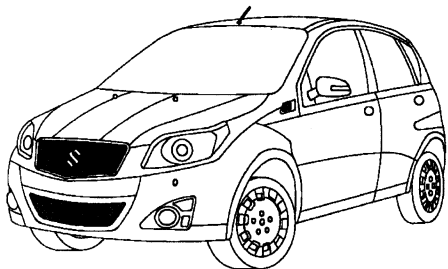

|   |                  |
|---|------------------|
| <b>DW01695<sup>a b</sup></b> Windshield .....   | <b>36.2x53.8</b> |
| <b>DD10639-40</b> Door F/R-L .....              | <b>21.8x38.0</b> |
| <b>DD11780-81</b> Door R/R-L .....              | <b>19.0x24.5</b> |
| <b>DR10866</b> Roof (Solar) .....               | <b>15.0x31.5</b> |
| <b>DQ10646-47<sup>d</sup></b> Quarter R-L ..... | <b>9.0x14.5</b>  |

**Swift (cont.)**

|   |                  |
|---|------------------|
| <b>DB11706<sup>c</sup></b> Back Window (Heated) (W/Wiper) ..... | <b>18.5x52.5</b> |
| <sup>a</sup> Urethane,Dam,Primer - 2 Tubes                      |                  |
| <sup>b</sup> Fast-Cure Urethane/Dam/Primer - Quantity 2         |                  |
| <sup>c</sup> Urethane,Dam,Primer - 1.5 Tubes                    |                  |
| <sup>d</sup> Urethane,Dam,Primer - 1 Tube                       |                  |

**Swift 4 Door Hatchback (MEXICO Only) ..... 2007-2010**

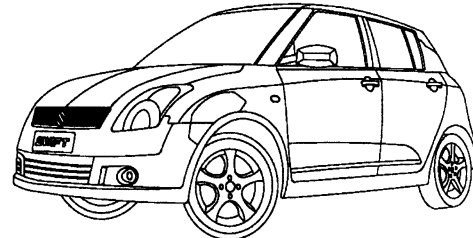

|   |  |
|---|--|
| <b>FW02768<sup>a b</sup></b> Windshield (Mexico Only) .....         |  |
| <b>FD23498-99</b> Door F/R-L (Mexico Only) .....                    |  |
| <b>FD23500-01</b> Door R/R-L (Mexico Only) .....                    |  |
| <b>FV23502-03</b> Vent R/R-L (Mexico Only) .....                    |  |
| <b>FB23504<sup>c</sup></b> Back Window (Heated) (Mexico Only) ..... |  |
| <sup>a</sup> Urethane,Dam,Primer - 2 Tubes                          |  |
| <sup>b</sup> Fast-Cure Urethane/Dam/Primer - Quantity 2             |  |
| <sup>c</sup> Urethane,Dam,Primer - 1.5 Tubes                        |  |

**Swift 4 Door Hatchback ..... 2006-2008 (CANADA Only)**

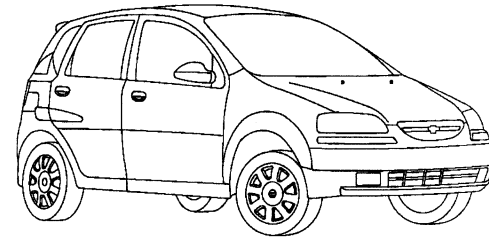

|  |                  |
|--|------------------|
| <b>DW01561<sup>a b</sup></b> Windshield .....                            | <b>36.9x53.8</b> |
| <b>DD10639-40</b> Door F/R-L .....                                       | <b>21.8x38.0</b> |
| <b>DD10644-45</b> Door R/R-L .....                                       | <b>19.0x24.5</b> |
| <b>DQ10646-47<sup>d</sup></b> Quarter R-L .....                          | <b>9.0x14.5</b>  |
| <b>DB10648<sup>c</sup></b> Back Window (Heated)(1 Holes) (W/Wiper) ..... | <b>19.0x54.5</b> |
| <sup>a</sup> Urethane,Dam,Primer - 2 Tubes                               |                  |
| <sup>b</sup> Fast-Cure Urethane/Dam/Primer - Quantity 2                  |                  |
| <sup>c</sup> Urethane,Dam,Primer - 1.5 Tubes                             |                  |
| <sup>d</sup> Urethane,Dam,Primer - 1 Tube                                |                  |

**Verona 4 Door Sedan..... 2006**

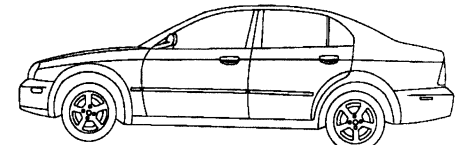

|  |                  |
|--|------------------|
| <b>FW02578<sup>a b</sup></b> Windshield (Heated)(Solar) (Heated Wiper Park Area) | <b>34.0x58.5</b> |
| <b>FW02445<sup>a b</sup></b> Windshield (Solar) .....                            | <b>34.0x58.5</b> |



**Verona**

(cont.)

|                              |  |                  |
|------------------------------|--|------------------|
| <b>FW02444<sup>a b</sup></b> | Windshield .....                       | <b>34.0x58.5</b> |
| <b>FD22175-76</b>            | Door F/R-L (2 Holes)(Solar) .....      | <b>20.0x30.0</b> |
| <b>FD22173-74</b>            | Door F/R-L (2 Holes) .....             | <b>20.0x30.0</b> |
| <b>FD22179-80</b>            | Door R/R-L (2 Holes)(Solar) .....      | <b>20.0x27.0</b> |
| <b>FD22177-78</b>            | Door R/R-L (2 Holes) .....             | <b>20.0x27.0</b> |
| <b>FV22183-84</b>            | Vent R/R-L (Solar) .....               | <b>9.5x12.0</b>  |
| <b>FV22181-82</b>            | Vent R/R-L .....                       | <b>9.5x12.0</b>  |
| <b>FB22186<sup>a</sup></b>   | Back Window (Ant)(Heated)(Solar) ..... | <b>31.0x52.0</b> |
| <b>FB22185<sup>a</sup></b>   | Back Window (Ant)(Heated) .....        | <b>31.0x52.0</b> |

<sup>a</sup> Urethane,Dam,Primer - 2 Tubes

<sup>b</sup> Fast-Cure Urethane/Dam/Primer - Quantity 2

**XL-7 4 Door Utility..... 2006**

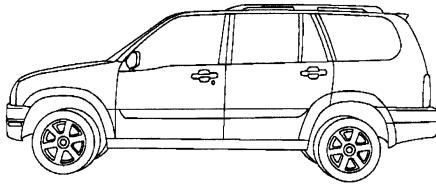

|                               |  |                  |
|-------------------------------|--|------------------|
| <b>FW02423<sup>a b</sup></b>  | Windshield (Solar) (W/Third Visor Frit) .....  | <b>31.0x55.0</b> |
| <b>FD20522-23</b>             | Door F/R-L (2 Holes)(Solar) .....              | <b>24.0x38.5</b> |
| <b>FD21256-57</b>             | Door R/R-L (2 Holes)(Solar) .....              | <b>23.7x23.9</b> |
| <b>FQ21260-61<sup>d</sup></b> | Quarter R-L (Solar) .....                      | <b>18.0x30.0</b> |
| <b>FV21258-59</b>             | Vent R/R-L (Solar) .....                       | <b>10.4x18.5</b> |
| <b>FB20530<sup>c</sup></b>    | Back Window (Heated)(Solar) (Paint Band) ..... | <b>21.0x51.0</b> |

<sup>a</sup> Urethane,Dam,Primer - 2 Tubes

<sup>b</sup> Fast-Cure Urethane/Dam/Primer - Quantity 2

<sup>c</sup> Urethane,Dam,Primer - 1.5 Tubes

<sup>d</sup> Urethane,Dam,Primer - 1 Tube

**XL7 4 Door Utility..... 2007-2010**

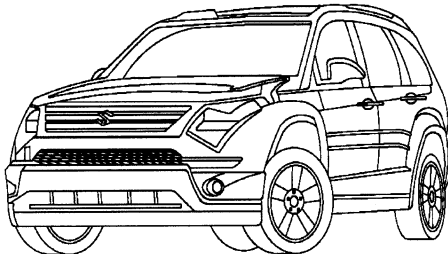

|                              |  |                  |
|------------------------------|--|------------------|
| <b>FW02741<sup>a b</sup></b> | Windshield (Solar) (W/Third Visor Frit) .....    | <b>37.4x51.1</b> |
| <b>FD23425-26</b>            | Door F/R-L (1 Holes)(Solar) .....                | <b>22.5x35.5</b> |
| <b>FD23427-28</b>            | Door R/R-L (1 Holes)(Solar) .....                | <b>21.5x31.5</b> |
| <b>FQ23430<sup>d</sup></b>   | Quarter L (Encap)(Solar) .....                   | <b>20.0x33.0</b> |
| <b>FQ23429<sup>d</sup></b>   | Quarter R (Encap)(Solar) (W/Keyless Entry) ..... | <b>20.0x33.0</b> |
| <b>FB23431<sup>c</sup></b>   | Back Window (Heated)(Solar) .....                | <b>18.0x54.5</b> |

<sup>a</sup> Urethane,Dam,Primer - 2 Tubes

<sup>b</sup> Fast-Cure Urethane/Dam/Primer - Quantity 2

<sup>c</sup> Urethane,Dam,Primer - 1.5 Tubes

<sup>d</sup> Urethane,Dam,Primer - 1 Tube

**Toyota**

**4Runner 4 Door Utility..... 2010-2011**

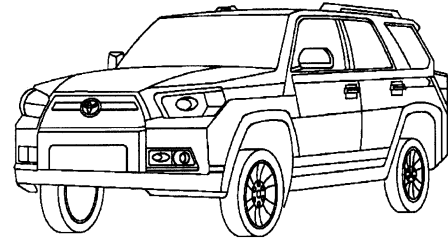

|                               |  |                  |
|-------------------------------|--|------------------|
| <b>FW03185<sup>a b</sup></b>  | Windshield (Heated)(Solar) (Electrochromic Mirror, W/Third Visor Frit, Heated Wiper Park Area) ..... | <b>26.5x59.0</b> |
| <b>FW03184<sup>a b</sup></b>  | Windshield (Solar) (Electrochromic Mirror, W/Third Visor Frit) .....                                 | <b>26.5x59.0</b> |
| <b>FW03183<sup>a b</sup></b>  | Windshield (Heated)(Solar) (W/Third Visor Frit, Heated Wiper Park Area) .....                        | <b>26.5x59.0</b> |
| <b>FW03176<sup>a b</sup></b>  | Windshield (Solar) (W/Third Visor Frit) .....  | <b>26.5x59.0</b> |
| <b>FD24496-97</b>             | Door F/R-L (Solar) .....   | <b>20.0x34.5</b> |
| <b>FD24498-99</b>             | Door R/R-L (Solar) .....   | <b>20.0x23.5</b> |
| <b>FQ24502-03<sup>d</sup></b> | Quarter R-L (Solar) .....  | <b>16.5x29.0</b> |
| <b>FV24500-01</b>             | Vent R/R-L (Solar) .....   | <b>8.0x13.5</b>  |
| <b>FB24504<sup>c</sup></b>    | Back Window (Heated)(Solar) .....  | <b>20.0x46.0</b> |

<sup>a</sup> Urethane,Dam,Primer - 2 Tubes

<sup>b</sup> Fast-Cure Urethane/Dam/Primer - Quantity 2

<sup>c</sup> Urethane,Dam,Primer - 1.5 Tubes

<sup>d</sup> Urethane,Dam,Primer - 1 Tube

**4Runner 4 Door Utility..... 2006-2009**

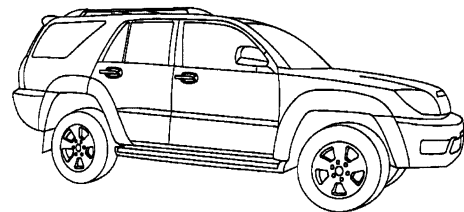

|                               |  |                  |
|-------------------------------|--|------------------|
| <b>FW02372<sup>a b</sup></b>  | Windshield .....                         | <b>28.0x59.3</b> |
| <b>FW02371<sup>a b</sup></b>  | Windshield (Electrochromic Mirror) ..... | <b>28.0x59.3</b> |
| <b>FD21878-79</b>             | Door F/R-L (Solar) .....                 | <b>20.0x35.0</b> |
| <b>FD21880-81</b>             | Door R/R-L (Solar) .....                 | <b>19.7x21.3</b> |
| <b>FQ21884-85<sup>d</sup></b> | Quarter R-L (Ant)(Solar) .....           | <b>19.0x35.0</b> |
| <b>FV21882-83</b>             | Vent R/R-L (Solar) .....                 | <b>10.4x16.5</b> |
| <b>FB21886<sup>c</sup></b>    | Back Window (Heated)(Solar) .....        | <b>17.0x47.5</b> |

<sup>a</sup> Urethane,Dam,Primer - 2 Tubes

<sup>b</sup> Fast-Cure Urethane/Dam/Primer - Quantity 2

<sup>c</sup> Urethane,Dam,Primer - 1.5 Tubes

<sup>d</sup> Urethane,Dam,Primer - 1 Tube

**Avalon 4 Door Sedan..... 2006-2011**

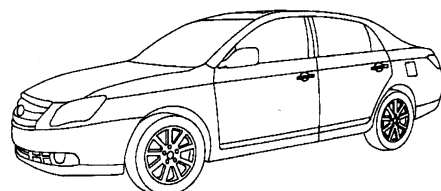

**Avalon (cont.)**

|  |           |
|--|-----------|
| FW02980 <sup>a c d e f</sup> Windshield (Solar) (Electrochromic Mirror, Rain Sensor) .....                                       | 39.2x61.1 |
| FW02534 <sup>b e f</sup> Windshield (Solar) (Electrochromic Mirror, Acoustic Interlayer, Rain Sensor) (To 02/2010) (06-10) ..... | 39.2x61.1 |
| FW02533 <sup>b e f</sup> Windshield (Solar) (Electrochromic Mirror, Acoustic Interlayer) (To 02/2010) (06-10) .....              | 39.2x61.1 |
| FW02532 <sup>b e f</sup> Windshield (Solar) (Electrochromic Mirror) .....  | 39.2x61.1 |
| FW02531 <sup>b e f</sup> Windshield (Solar) (To 02/2010) (06-10) .....   | 39.2x61.1 |
| FD22556-57 Door F/R-L (Solar) .....  | 19.3x38.5 |
| FD22558-59 Door R/R-L (Solar) .....  | 20.0x28.5 |
| FV22560-61 Vent R/R-L (Solar) .....  | 10.0x11.0 |
| FB22515 <sup>e</sup> Back Window (Ant)(Heated)(Solar) (W/Diversity Antenna) .....  | 31.0x52.0 |

<sup>a</sup> Not On Production Vehicles  
<sup>b</sup> On Production Vehicles  
<sup>c</sup> Not On Production Vehicles Up To 2/2010  
<sup>d</sup> On Production Vehicles From 2/2010  
<sup>e</sup> Urethane,Dam,Primer - 2 Tubes  
<sup>f</sup> Fast-Cure Urethane/Dam/Primer - Quantity 2

**Avanza 4 Door Hatchback (MEXICO Only)..... 2007-2010**

|  |  |
|--|--|
| FW02903 <sup>a b</sup> Windshield (Solar) (Mexico Only) .....        |  |
| FD23700-01 Door F/R-L (Solar) (Mexico Only) .....                    |  |
| FD23702-03 Door R/R-L (Solar) (Mexico Only) .....                    |  |
| FQ23704-05 <sup>c</sup> Quarter R-L (Solar) (Mexico Only) .....      |  |
| FB23706 <sup>c</sup> Back Window (Heated)(Solar) (Mexico Only) ..... |  |

<sup>a</sup> Urethane,Dam,Primer - 2 Tubes  
<sup>b</sup> Fast-Cure Urethane/Dam/Primer - Quantity 2  
<sup>c</sup> Urethane,Dam,Primer - 1.5 Tubes

**Camry 4 Door Sedan ..... 2007-2011**

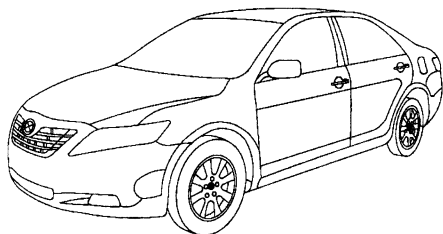

|   |           |
|---|-----------|
| FW02628 <sup>a b</sup> Windshield (Solar) (Electrochromic Mirror, W/Third Visor Frit) ..... | 39.0x58.3 |
| FW02627 <sup>a b</sup> Windshield (Solar) (W/Third Visor Frit) .....                        | 39.0x58.3 |
| FD23698-99 Door F/R-L (Solar) (Japan Built) .....   | 20.0x36.5 |
| FD22929-30 Door F/R-L (Solar) (USA Built) .....   | 20.0x36.5 |
| FD22931-32 Door R/R-L (Solar) .....   | 17.0x24.5 |
| FV22933-34 Vent R/R-L (Solar) .....   | 11.0x14.5 |
| FB23196 <sup>a</sup> Back Window (Ant)(Heated)(Solar) (W/Diversity Antenna) .....           | 33.0x51.0 |
| FB23176 <sup>a</sup> Back Window (Ant)(Solar) .....   | 33.0x51.0 |
| FB22935 <sup>a</sup> Back Window (Ant)(Heated)(Solar) .....                                 | 33.0x51.0 |

<sup>a</sup> Urethane,Dam,Primer - 2 Tubes  
<sup>b</sup> Fast-Cure Urethane/Dam/Primer - Quantity 2

**Camry HYBRID 4 Door Sedan..... 2007-2011**

|  |           |
|--|-----------|
| FW02719 <sup>b c d</sup> Windshield (Solar) (Electrochromic Mirror, W/Third Visor Frit, Acoustic Interlayer) ..... | 39.0x58.3 |
| FW02718 <sup>b c d</sup> Windshield (Solar) (W/Third Visor Frit, Acoustic Interlayer) .....                        | 39.0x58.3 |
| FW02628 <sup>a c d</sup> Windshield (Solar) (Electrochromic Mirror, W/Third Visor Frit) .....                      | 39.0x58.3 |
| FW02627 <sup>a c d</sup> Windshield (Solar) (W/Third Visor Frit) .....   | 39.0x58.3 |
| FD23698-99 Door F/R-L (Solar) (Japan Built) .....  | 20.0x36.5 |
| FD22929-30 Door F/R-L (Solar) (USA Built) .....  | 20.0x36.5 |
| FD22931-32 Door R/R-L (Solar) .....  | 17.0x24.5 |
| FV22933-34 Vent R/R-L (Solar) .....  | 11.0x14.5 |
| FB23196 <sup>c</sup> Back Window (Ant)(Heated)(Solar) (W/Diversity Antenna) .....                                  | 33.0x51.0 |

<sup>a</sup> Not On Production Vehicles  
<sup>b</sup> On Production Vehicles  
<sup>c</sup> Urethane,Dam,Primer - 2 Tubes  
<sup>d</sup> Fast-Cure Urethane/Dam/Primer - Quantity 2

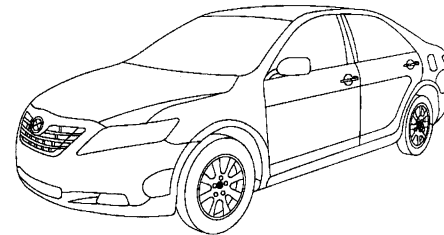

**Camry 4 Door Sedan ..... 2006**

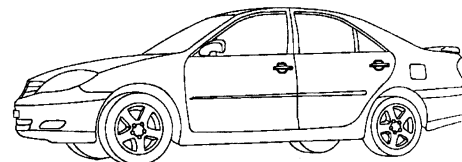

|   |           |
|---|-----------|
| FW02598 <sup>a b</sup> Windshield (Solar) (From 08/20/2005) .....                       | 36.4x59.8 |
| FW02268 <sup>a b</sup> Windshield (Solar) (Electrochromic Mirror) (To 08/20/2005) ..... | 36.4x59.8 |
| FW02267 <sup>a b</sup> Windshield (Solar) (To 08/20/2005) .....                         | 36.4x59.8 |
| FD22085-86 Door F/R-L (Solar) (Japan Built) .....                                       | 20.6x36.5 |
| FD21405-06 Door F/R-L (Solar) (USA Built) .....   | 20.6x36.5 |
| FD22087-88 Door R/R-L (Solar) (Japan Built) .....                                       | 18.7x28.0 |
| FD21407-08 Door R/R-L (Solar) (USA Built) .....   | 18.7x28.0 |
| FV22089-90 Vent R/R-L (Solar) (Japan Built) .....                                       | 9.8x11.2  |
| FV21409-10 Vent R/R-L (Solar) (USA Built) .....   | 9.8x11.2  |
| FB21412 <sup>a</sup> Back Window (Ant)(Heated)(Solar) (W/Diversity Antenna) .....       | 30.0x57.5 |
| FB21411 <sup>a</sup> Back Window (Ant)(Heated)(Solar) .....                             | 30.0x57.5 |

<sup>a</sup> Urethane,Dam,Primer - 2 Tubes  
<sup>b</sup> Fast-Cure Urethane/Dam/Primer - Quantity 2

**Corolla 4 Door Sedan ..... 2009-2011**

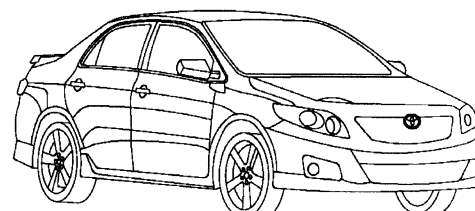

|   |           |
|---|-----------|
| FW03261 <sup>a c d</sup> Windshield (W/Third Visor Frit, Aftermarket) ..... | 36.0x56.0 |
|---|-----------|

| <b>Corolla</b>  | <b>(cont.)</b> |
|---|----------------|
| <b>FW03260<sup>a c d</sup></b> Windshield (Solar) (W/Third Visor Frit, Aftermarket)                       | 36.0x56.0      |
| <b>FW02959<sup>b c d</sup></b> Windshield (USA, Japan Built, W/Third Visor Frit, Acoustic Interlayer)     | 36.0x56.0      |
| <b>FW02899<sup>b c d</sup></b> Windshield (Solar) (W/Third Visor Frit, Acoustic Interlayer, Canada Built) | 36.0x56.0      |
| <b>FD24136-37</b> Door F/R-L (Solar) (USA, Canadian Built)  | 18.8x38.3      |
| <b>FD23691-92</b> Door F/R-L (Solar) (Japan Built)  | 18.8x38.3      |
| <b>FD23693-94</b> Door R/R-L (Solar)  | 19.3x26.0      |
| <b>FV23695-96</b> Vent R/R-L (Solar)  | 8.5x 9.5       |
| <b>FB23697<sup>c</sup></b> Back Window (Ant)(Heated)(Solar)   | 33.8x49.5      |

<sup>a</sup> Not On Production Vehicles  
<sup>b</sup> On Production Vehicles  
<sup>c</sup> Urethane,Dam,Primer - 2 Tubes  
<sup>d</sup> Fast-Cure Urethane/Dam/Primer - Quantity 2

**Corolla 4 Door Sedan ..... 2006-2008**

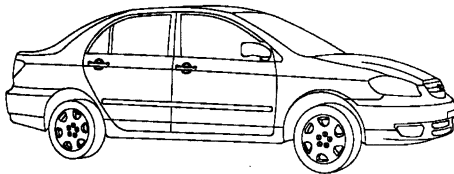

|  |           |
|--|-----------|
| <b>FW02298<sup>a b</sup></b> Windshield (W/Third Visor Frit) | 34.5x54.0 |
| <b>FD22347-48</b> Door F/R-L (Solar)                         | 19.5x32.0 |
| <b>FD22349-50</b> Door R/R-L (Solar)                         | 19.5x26.5 |
| <b>FV22351-52</b> Vent R/R-L (Solar)                         | 8.0x10.0  |
| <b>FB22353<sup>c</sup></b> Back Window (Heated)(Solar)       | 29.0x50.3 |

<sup>a</sup> Urethane,Dam,Primer - 2 Tubes  
<sup>b</sup> Fast-Cure Urethane/Dam/Primer - Quantity 2  
<sup>c</sup> Urethane,Dam,Primer - 1.5 Tubes

**Echo 4 Door Sedan ..... 2006 (CANADA Only)**

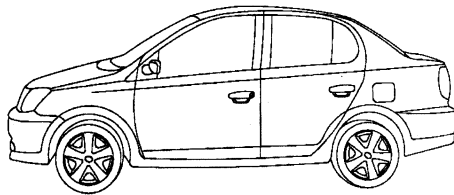

|  |           |
|--|-----------|
| <b>FW02375<sup>a b</sup></b> Windshield (W/Third Visor Frit)                   | 34.3x52.2 |
| <b>FD20887-88</b> Door F/R-L   | 23.5x36.5 |
| <b>FD20889-90</b> Door R/R-L   | 20.5x24.5 |
| <b>FV20891-92</b> Vent R/R-L   | 9.0x14.0  |
| <b>FB21820<sup>c</sup></b> Back Window (Heated) (W/Cold Climate Specification) | 26.5x51.0 |
| <b>FB20893<sup>c</sup></b> Back Window (Heated) (Standard Duty)                | 26.5x51.0 |
| <b>FB20865<sup>c</sup></b> Back Window   | 26.5x51.0 |

<sup>a</sup> Urethane,Dam,Primer - 2 Tubes  
<sup>b</sup> Fast-Cure Urethane/Dam/Primer - Quantity 2  
<sup>c</sup> Urethane,Dam,Primer - 1.5 Tubes

**FJ Cruiser 4 Door Utility ..... 2007-2011**

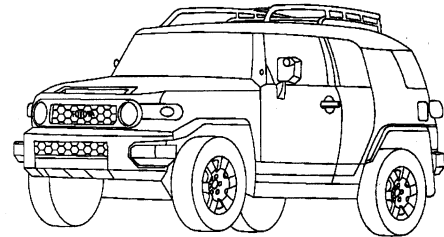

|   |           |
|---|-----------|
| <b>FW02652<sup>b c</sup></b> Windshield                               | 20.6x63.2 |
| <b>FD23053-54</b> Door F/R-L (Solar)                                  | 19.5x34.5 |
| <b>FD23055-56<sup>a d</sup></b> Door R/R-L (Solar) (Rear Access Door) | 15.5x17.0 |
| <b>FQ23057-58<sup>a d</sup></b> Quarter R-L (Solar)                   | 14.0x24.0 |
| <b>FB23059</b> Back Window (Ant)(Heated)(14 Holes)(Solar)             | 18.0x45.0 |

<sup>a</sup> Non-Reuseable Part  
<sup>b</sup> Urethane,Dam,Primer - 2 Tubes  
<sup>c</sup> Fast-Cure Urethane/Dam/Primer - Quantity 2  
<sup>d</sup> Urethane,Dam,Primer - 1 Tube

**Hiace Cargo Van (MEXICO Only) ..... 2006-2010**  
**Hiace Van (MEXICO Only) ..... 2006-2010**

|   |       |
|---|-------|
| <b>FW02693<sup>a b</sup></b> Windshield (W/Third Visor Frit, Mexico Only) | ..... |
| <b>FD23236-37</b> Door F/R-L (Mexico Only)                                | ..... |
| <b>FB24069<sup>c</sup></b> Back Window (Heated) (Mexico Only)             | ..... |

<sup>a</sup> Urethane,Dam,Primer - 2 Tubes  
<sup>b</sup> Fast-Cure Urethane/Dam/Primer - Quantity 2  
<sup>c</sup> Urethane,Dam,Primer - 1.5 Tubes

**Hiace Extended Cargo Van (MEXICO Only) ..... 2006-2010**  
**Hiace Extended Van (MEXICO Only) ..... 2006-2010**

|   |       |
|---|-------|
| <b>FW02693<sup>a b</sup></b> Windshield (W/Third Visor Frit, Mexico Only) | ..... |
| <b>FD23236-37</b> Door F/R-L (Mexico Only)                                | ..... |
| <b>FB24069<sup>c</sup></b> Back Window (Heated) (Mexico Only)             | ..... |

<sup>a</sup> Urethane,Dam,Primer - 2 Tubes  
<sup>b</sup> Fast-Cure Urethane/Dam/Primer - Quantity 2  
<sup>c</sup> Urethane,Dam,Primer - 1.5 Tubes

**Highlander 4 Door Utility ..... 2008-2011**

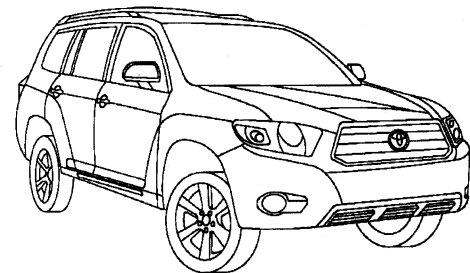

|  |           |
|--|-----------|
| <b>FW02870<sup>a b</sup></b> Windshield (Heated)(Solar) (W/Third Visor Frit, Heated Wiper Park Area) | 39.0x60.0 |
| <b>FW02869<sup>a b</sup></b> Windshield (Solar) (W/Third Visor Frit)                                 | 39.0x60.0 |
| <b>FD23622-23</b> Door F/R-L (Solar)   | 21.0x38.5 |
| <b>FD23624-25</b> Door R/R-L (Solar)   | 19.5x27.3 |
| <b>FQ24702-03<sup>d</sup></b> Quarter R-L (Ant)(Encap)(Solar) (Chrome Moulding) (11)                 | 17.0x21.8 |
| <b>FQ24700-01<sup>d</sup></b> Quarter R-L (Encap)(Solar) (Chrome Moulding) (11)                      | 17.0x21.8 |

**Highlander (cont.)**

|  |                  |
|--|------------------|
| <b>FQ23630-31<sup>d</sup></b> Quarter R-L (Ant)(Encap)(Solar) (Black Moulding) (08-10) ..... | <b>17.0x21.8</b> |
| <b>FQ23628-29<sup>d</sup></b> Quarter R-L (Encap)(Solar) (Black Moulding) (08-10) .....      | <b>17.0x21.8</b> |
| <b>FV23626-27</b> Vent R/R-L (Solar) .....   | <b>9.0x17.0</b>  |
| <b>FB23633</b> Back Window (Heated)(14 Holes)(Solar) (Movable) ..                            | <b>19.0x53.5</b> |
| <b>FB23632<sup>c</sup></b> Back Window (Heated)(11 Holes)(Solar) (Stationary) ..             | <b>19.0x53.5</b> |

<sup>a</sup> Urethane,Dam,Primer - 2 Tubes  
<sup>b</sup> Fast-Cure Urethane/Dam/Primer - Quantity 2  
<sup>c</sup> Urethane,Dam,Primer - 1.5 Tubes  
<sup>d</sup> Urethane,Dam,Primer - 1 Tube

**Highlander 4 Door Utility ..... 2006-2007**

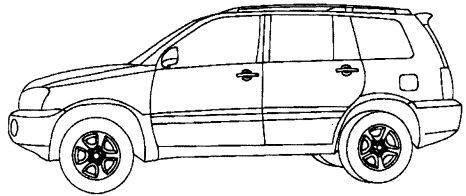

|   |                  |
|---|------------------|
| <b>FW02477<sup>b,c</sup></b> Windshield (Heated)(Solar) (Electrochromic Mirror, Heated Wiper Park Area) ..... | <b>33.0x60.0</b> |
| <b>FW02476<sup>c</sup></b> Windshield (Heated)(Solar) (Heated Wiper Park Area) .....                          | <b>33.0x60.0</b> |
| <b>FW02475<sup>b,c</sup></b> Windshield (Solar) (Electrochromic Mirror) .....                                 | <b>33.0x60.0</b> |
| <b>FW02474<sup>b,c</sup></b> Windshield (Solar) .....   | <b>33.0x60.0</b> |
| <b>FD21262-63</b> Door F/R-L (Solar) .....  | <b>18.5x36.0</b> |
| <b>FD21264-65</b> Door R/R-L (Solar) .....  | <b>19.0x25.0</b> |
| <b>FQ21270-71<sup>a</sup></b> Quarter R-L (Ant)(Encap)(Solar) (W/Diversity Antenna) .....                     | <b>17.0x22.5</b> |
| <b>FQ21268-69<sup>a</sup></b> Quarter R-L (Encap)(Solar) .....  | <b>17.0x22.5</b> |
| <b>FV21266-67</b> Vent R/R-L (Solar) .....  | <b>9.0x16.5</b>  |
| <b>FB21272<sup>d</sup></b> Back Window (Heated)(Solar) .....  | <b>17.6x54.8</b> |

<sup>a</sup> Non-Reuseable Part  
<sup>b</sup> Urethane,Dam,Primer - 2 Tubes  
<sup>c</sup> Fast-Cure Urethane/Dam/Primer - Quantity 2  
<sup>d</sup> Urethane,Dam,Primer - 1.5 Tubes  
<sup>e</sup> Urethane,Dam,Primer - 1 Tube

**Hilux 2 Door Standard Cab (MEXICO Only)..... 2006-2010**

|   |  |
|---|--|
| <b>FW02701<sup>a,b</sup></b> Windshield (Mexico Only) ..... |  |
| <b>FD23252-53</b> Door F/R-L (Mexico Only) .....            |  |
| <b>FB23259<sup>c</sup></b> Back Window (Mexico Only) .....  |  |

<sup>a</sup> Urethane,Dam,Primer - 2 Tubes  
<sup>b</sup> Fast-Cure Urethane/Dam/Primer - Quantity 2  
<sup>c</sup> Urethane,Dam,Primer - 1.5 Tubes

**Hilux 4 Door Crew Cab (MEXICO Only) ..... 2006-2010**

|   |  |
|---|--|
| <b>FW02701<sup>a,b</sup></b> Windshield (Mexico Only) .....         |  |
| <b>FD23254-55</b> Door F/R-L (Mexico Only) .....                    |  |
| <b>FD23256-57</b> Door R/R-L (Mexico Only) .....                    |  |
| <b>FB23258<sup>c</sup></b> Back Window (Heated) (Mexico Only) ..... |  |

<sup>a</sup> Urethane,Dam,Primer - 2 Tubes  
<sup>b</sup> Fast-Cure Urethane/Dam/Primer - Quantity 2  
<sup>c</sup> Urethane,Dam,Primer - 1.5 Tubes

**Land Cruiser 4 Door Utility ..... 2008-2011**

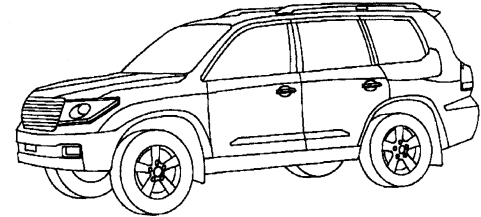

|   |                  |
|---|------------------|
| <b>FW03252<sup>a,b</sup></b> Windshield (Heated)(Solar) (W/Third Visor Frit, Heated Wiper Park Area, Rain Sensor) (10-11) ..... | <b>31.5x61.0</b> |
| <b>FW02908<sup>a,b</sup></b> Windshield (Heated)(Solar) (W/Third Visor Frit, Heated Wiper Park Area) .....                      | <b>31.5x61.0</b> |
| <b>FW02907<sup>a,b</sup></b> Windshield (Solar) (W/Third Visor Frit) .....  | <b>31.5x61.0</b> |
| <b>FD23724-25</b> Door F/R-L (Solar) .....  | <b>21.0x32.5</b> |
| <b>FD23726-27</b> Door R/R-L (Solar) .....  | <b>21.0x24.5</b> |
| <b>FQ23730-31<sup>d</sup></b> Quarter R-L (Encap)(Solar) .....  | <b>20.0x27.5</b> |
| <b>FV23728-29</b> Vent R/R-L (Solar) .....  | <b>8.5x19.0</b>  |
| <b>FB23732<sup>c</sup></b> Back Window (Ant)(Heated)(1 Holes)(Solar) .....  | <b>20.5x58.5</b> |

<sup>a</sup> Urethane,Dam,Primer - 2 Tubes  
<sup>b</sup> Fast-Cure Urethane/Dam/Primer - Quantity 2  
<sup>c</sup> Urethane,Dam,Primer - 1.5 Tubes  
<sup>d</sup> Urethane,Dam,Primer - 1 Tube

**Land Cruiser 4 Door Utility ..... 2006-2007**

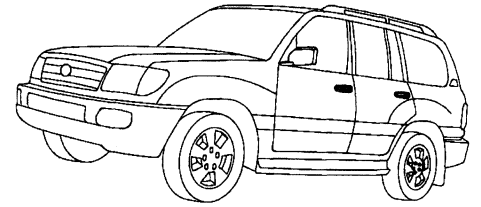

|  |                  |
|--|------------------|
| <b>FW02074<sup>a,b</sup></b> Windshield .....                          | <b>30.6x62.0</b> |
| <b>FD20390-91</b> Door F/R-L .....                                     | <b>23.5x36.0</b> |
| <b>FD20392-93</b> Door R/R-L .....                                     | <b>23.0x25.0</b> |
| <b>FQ21422</b> Quarter L (1 Holes) (Movable) .....                     | <b>19.8x34.0</b> |
| <b>FQ21421</b> Quarter R (Ant)(1 Holes) (Movable) .....                | <b>19.8x34.0</b> |
| <b>FQ20396-97<sup>d,e</sup></b> Quarter R-L (Encap) (Stationary) ..... | <b>19.8x34.0</b> |
| <b>FV20394-95</b> Vent R/R-L .....                                     | <b>10.0x20.5</b> |
| <b>FB20398<sup>c</sup></b> Back Window (Heated) .....                  | <b>22.0x55.0</b> |

<sup>a</sup> Urethane,Dam,Primer - 2 Tubes  
<sup>b</sup> Fast-Cure Urethane/Dam/Primer - Quantity 2  
<sup>c</sup> Urethane,Dam,Primer - 1.5 Tubes  
<sup>d</sup> Urethane,Dam,Primer - 1 Tube  
<sup>e</sup> Encapsulation Lubricant

**Matrix 4 Door Hatchback ..... 2009-2011**

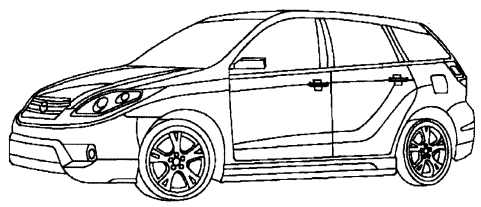

|  |                  |
|--|------------------|
| <b>FW02900<sup>a,b</sup></b> Windshield (W/Third Visor Frit) ..... | <b>37.0x54.5</b> |
| <b>FD23739-40</b> Door F/R-L (Solar) .....                         | <b>19.8x37.0</b> |
| <b>FD23741-42</b> Door R/R-L (Solar) .....                         | <b>19.5x28.3</b> |
| <b>FQ23743-44<sup>d</sup></b> Quarter R-L (Encap)(Solar) .....     | <b>8.0x16.0</b>  |
| <b>FB24567<sup>c</sup></b> Back Window (Heated)(Solar) .....       | <b>18.0x50.0</b> |

**Matrix (cont.)**

- FB23745<sup>c</sup> Back Window (Heated)(1 Holes)(Solar) (W/Wiper) ... 18.0x50.0
- <sup>a</sup> Urethane,Dam,Primer - 2 Tubes
- <sup>b</sup> Fast-Cure Urethane/Dam/Primer - Quantity 2
- <sup>c</sup> Urethane,Dam,Primer - 1.5 Tubes
- <sup>d</sup> Urethane,Dam,Primer - 1 Tube

**Matrix 4 Door Hatchback..... 2006-2008**

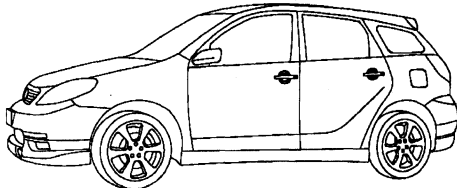

- FW02479<sup>a b</sup> Windshield (Solar) ..... 38.5x58.0
- DD10188-89 Door F/R-L (Solar) ..... 19.0x33.0
- DD10190-91 Door R/R-L (Solar) ..... 19.0x27.0
- FQ22354-55<sup>c</sup> Quarter R-L (Encap)(Solar) ..... 14.5x25.0
- FB22356 Back Window (Heated)(13 Holes)(Solar) ..... 20.9x57.0
- <sup>a</sup> Urethane,Dam,Primer - 2 Tubes
- <sup>b</sup> Fast-Cure Urethane/Dam/Primer - Quantity 2
- <sup>c</sup> Urethane,Dam,Primer - 1 Tube

**Prius 4 Door Hatchback..... 2010-2011**

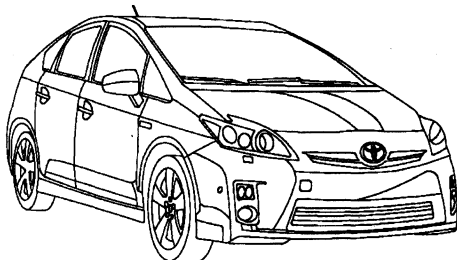

- FW03140<sup>a b</sup> Windshield (Solar) (Electrochromic Mirror, W/Third Visor Frit, W/Lane Departure Warning System) ..... 41.0x54.5
- FW03139<sup>a b</sup> Windshield (Solar) (Electrochromic Mirror, W/Third Visor Frit) ..... 41.0x54.5
- FW03138<sup>a b</sup> Windshield (Solar) (W/Third Visor Frit) ..... 41.0x54.5
- FD24402-03 Door F/R-L (Solar) (Hydrophobic Coating) ..... 20.0x35.0
- FD24400-01 Door F/R-L (Solar) ..... 20.0x35.0
- FD24404-05 Door R/R-L (Solar) ..... 19.0x28.0
- FR24635 Roof F (Solar) (Movable) .....
- FR24637<sup>c</sup> Roof R (Solar) (Stationary) .....
- FR24636 Roof C (Solar) (Movable) .....
- FQ24406-07<sup>d</sup> Quarter R-L (Encap)(Solar) ..... 14.0x17.0
- FV24398-99<sup>d</sup> Vent F/R-L (Encap)(Solar) ..... 10.0x18.0
- FB24576<sup>c</sup> Back Window Upper (Heated)(Solar) ..... 25.0x45.5
- FB24409<sup>d</sup> Back Window Lower (Heated)(Solar) ..... 6.5x45.5
- FB24408<sup>c</sup> Back Window Upper (Ant)(Heated)(1 Holes)(Solar) (W/Wiper) ..... 25.0x45.5
- <sup>a</sup> Urethane,Dam,Primer - 2 Tubes
- <sup>b</sup> Fast-Cure Urethane/Dam/Primer - Quantity 2
- <sup>c</sup> Urethane,Dam,Primer - 1.5 Tubes
- <sup>d</sup> Urethane,Dam,Primer - 1 Tube

**Prius 4 Door Hatchback ..... 2006-2009**

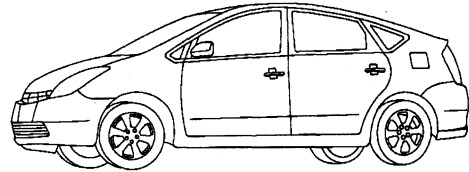

- FW02602<sup>a d e</sup> Windshield (Acoustic Interlayer) ..... 39.5x56.0
- FW02454<sup>b c d e</sup> Windshield ..... 39.5x56.0
- FD22244-45 Door F/R-L (Solar) ..... 20.0x34.5
- FD22246-47 Door R/R-L (Solar) ..... 20.0x31.0
- FQ22248-49<sup>e</sup> Quarter R-L (Encap)(Solar) ..... 15.0x17.5
- FV22242-43 Vent F/R-L (Encap)(Solar) ..... 8.0x12.0
- FB22313<sup>f</sup> Back Window Upper (Ant)(Heated)(Solar) ..... 25.2x44.8
- FB22251<sup>e</sup> Back Window Lower (Heated)(Solar) ..... 6.5x44.5
- FB22250<sup>f</sup> Back Window Upper (Ant)(Heated)(1 Holes)(Solar) (W/Wiper) ..... 25.2x44.8
- <sup>a</sup> On Production Vehicles
- <sup>b</sup> Not On Production Vehicles 2005-2009
- <sup>c</sup> On Production Vehicles 2004 Only
- <sup>d</sup> Urethane,Dam,Primer - 2 Tubes
- <sup>e</sup> Fast-Cure Urethane/Dam/Primer - Quantity 2
- <sup>f</sup> Urethane,Dam,Primer - 1.5 Tubes
- <sup>g</sup> Urethane,Dam,Primer - 1 Tube

**RAV4 4 Door Utility ..... 2006-2011**

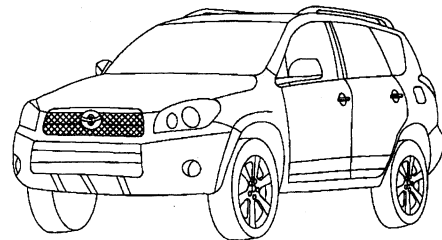

- FW02669<sup>a b</sup> Windshield (Heated) (W/Third Visor Frit, Heated Wiper Park Area) ..... 35.0x56.0
- FW02625<sup>a b</sup> Windshield (W/Third Visor Frit) ..... 35.0x56.0
- FD22914-15 Door F/R-L (Solar) ..... 21.8x36.3
- FD22916-17 Door R/R-L (Solar) ..... 19.5x28.5
- FQ22920-21<sup>d</sup> Quarter R-L (Encap)(Solar) ..... 16.3x23.5
- FV22918-19 Vent R/R-L (Solar) ..... 7.0x15.5
- FB22922<sup>c</sup> Back Window (Ant)(Heated)(Solar) ..... 18.0x51.0
- <sup>a</sup> Urethane,Dam,Primer - 2 Tubes
- <sup>b</sup> Fast-Cure Urethane/Dam/Primer - Quantity 2
- <sup>c</sup> Urethane,Dam,Primer - 1.5 Tubes
- <sup>d</sup> Urethane,Dam,Primer - 1 Tube

**Sequoia 4 Door Utility ..... 2008-2011**

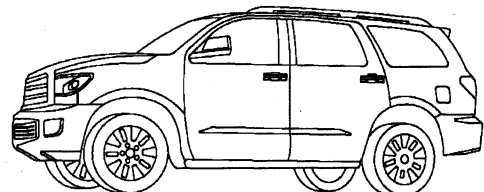

- FW03218<sup>c d e</sup> Windshield (Heated)(Solar) (W/Third Visor Frit, Heated Wiper Park Area) (From 02/22/2010) (10-11) ... 35.8x65.8

| <i>Sequoia</i>  | (cont.)   |
|---|-----------|
| FW03217 <sup>b d e</sup> Windshield (Solar) (W/Third Visor Frit) (From 02/22/2010) (10-11) .....                                  | 35.8x65.8 |
| FW02724 <sup>d e</sup> Windshield (Heated)(Solar) (W/Third Visor Frit, Infrared Interlayer, Heated Wiper Park Area) (08-10) ..... | 35.8x65.8 |
| FW02723 <sup>d e</sup> Windshield (Solar) (W/Third Visor Frit, Infrared Interlayer) (08-10) .....                                 | 35.8x65.8 |
| FW02722 <sup>d e</sup> Windshield (Heated)(Solar) (W/Third Visor Frit, Heated Wiper Park Area) .....                              | 35.8x65.8 |
| FW02721 <sup>d e</sup> Windshield (Solar) (W/Third Visor Frit) .....  | 35.8x65.8 |
| FD23323-24 Door F/R-L (Solar) .....   | 23.0x35.0 |
| FD23480-81 Door R/R-L (Solar) .....   | 23.5x32.5 |
| FQ23329-30 <sup>a f</sup> Quarter R-L (Ant)(Solar) (W/Sunshade) .....   | 17.5x35.0 |
| FQ23327-28 <sup>a f</sup> Quarter R-L (Ant)(Solar) .....  | 17.5x35.0 |
| FB23331 Back Window (Heated)(Solar) .....   | 22.3x55.7 |

<sup>a</sup> Non-Reuseable Part  
<sup>b</sup> Paint Band Different Than FW02721GBY  
<sup>c</sup> Paint Band Different Than FW02722GBY  
<sup>d</sup> Urethane,Dam,Primer - 2 Tubes  
<sup>e</sup> Fast-Cure Urethane/Dam/Primer - Quantity 2  
<sup>f</sup> Urethane,Dam,Primer - 1 Tube

**Sequoia 4 Door Utility ..... 2006-2007**

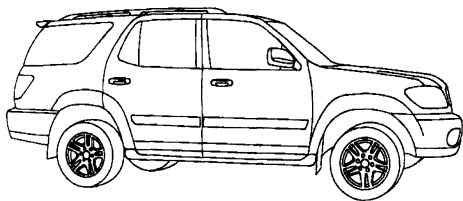

|  |           |
|--|-----------|
| FW02508 <sup>b c</sup> Windshield (Solar) (W/Third Visor Frit) ..... | 28.3x61.4 |
| FD21322-23 Door F/R-L (Solar) .....                                  | 24.0x37.0 |
| FD21324-25 Door R/R-L (Solar) .....                                  | 24.0x28.5 |
| FQ22412-13 <sup>a d</sup> Quarter R-L (Ant)(Encap)(Solar) .....      | 18.0x46.0 |
| FQ21328-29 <sup>a d</sup> Quarter R-L (Encap)(Solar) .....           | 18.0x46.0 |
| FV21326-27 Vent R/R-L (Solar) .....                                  | 9.1x18.5  |
| FB21331 Back Window (Heated)(Solar) .....                            | 21.5x52.5 |

<sup>a</sup> Non-Reuseable Part  
<sup>b</sup> Urethane,Dam,Primer - 2 Tubes  
<sup>c</sup> Fast-Cure Urethane/Dam/Primer - Quantity 2  
<sup>d</sup> Urethane,Dam,Primer - 1.5 Tubes

**Sienna Mini Van ..... 2011**

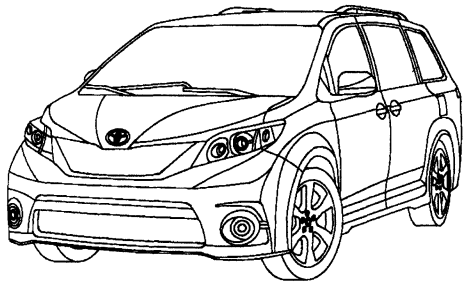

|   |           |
|---|-----------|
| FW03241 <sup>a c d e</sup> Windshield (Heated)(Solar) (W/Third Visor Frit, Heated Wiper Park Area, Rain Sensor) ..... | 44.0x65.0 |
| FW03240 <sup>a d e</sup> Windshield (Heated)(Solar) (W/Third Visor Frit, Heated Wiper Park Area) .....                | 44.0x65.0 |
| FW03199 <sup>a c d e</sup> Windshield (Solar) (W/Third Visor Frit, Rain Sensor) .....                                 | 44.0x65.0 |
| FW03198 <sup>a d e</sup> Windshield (Solar) (W/Third Visor Frit) .....  | 44.0x65.0 |
| FD24560-61 Door F/R-L (Solar) .....   | 21.0x33.0 |
| FD24562-63 Door R/R-L (Solar) (Movable) .....   | 21.0x38.0 |

| <i>Sienna</i>   | (cont.)   |
|---|-----------|
| FQ24609-10 Quarter R-L (Ant)(Encap)(1 Holes)(Solar) (Movable, W/Sunshade Hooks) ..... | 18.8x38.5 |
| FQ24607-08 Quarter R-L (Encap)(1 Holes)(Solar) (Movable) .....                        | 18.8x38.5 |
| FQ24564-65 Quarter R-L (Encap)(1 Holes)(Solar) (Movable, W/Sunshade Hooks) .....      | 18.5x36.0 |
| FV24558-59 Vent F/R-L (Encap)(Solar) .....  | 9.5x10.5  |
| FB24566 <sup>b</sup> Back Window (Encap)(Heated)(Solar) .....                         | 23.0x61.0 |

<sup>a</sup> May Require Two Person Installation  
<sup>b</sup> Urethane,Dam,Primer - 2 Tubes  
<sup>c</sup> Rain Sensor Kit  
<sup>d</sup> Urethane,Dam,Primer - 2.5 Tubes  
<sup>e</sup> Fast-Cure Urethane/Dam/Primer - Quantity 2.5

**Sienna Mini Van ..... 2006-2010**

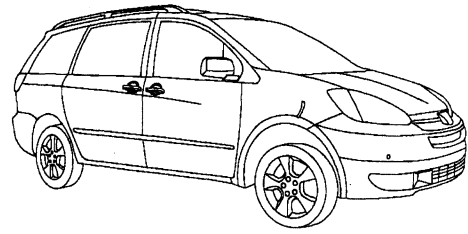

|  |           |
|--|-----------|
| FW02422 <sup>a b c</sup> Windshield (06) .....                                     | 41.0x64.5 |
| FW02421 <sup>a b c</sup> Windshield (Solar) .....                                  | 41.0x64.5 |
| FW02411 <sup>a b c</sup> Windshield (Heated) (Heated Wiper Park Area) (06) ..      | 41.0x64.5 |
| FW02395 <sup>a b c</sup> Windshield (Heated)(Solar) (Heated Wiper Park Area) ..... | 41.0x64.5 |
| FD22038-39 Door F/R-L .....  | 23.0x35.0 |
| FD21973-74 Door F/R-L (Solar) .....  | 23.0x35.0 |
| FD22040-41 Door R/R-L (Sliding Cargo Door) .....                                   | 24.0x39.0 |
| FD21975-76 Door R/R-L (Solar) (Sliding Cargo Door) .....                           | 24.0x39.0 |
| FQ22048-49 Quarter R-L (Ant)(1 Holes)(Solar) (Movable, W/Sunshade Hooks) .....     | 19.0x34.0 |
| FQ22046-47 Quarter R-L (1 Holes)(Solar) (Movable, W/Sunshade Hooks) .....          | 19.0x34.0 |
| FQ22044-45 Quarter R-L (1 Holes)(Solar) (Movable) .....                            | 19.0x34.0 |
| FQ22042-43 Quarter R-L (1 Holes) (Movable) .....                                   | 19.0x34.0 |
| FQ21977-78 Quarter R-L (Ant)(1 Holes)(Solar) (Movable) .....                       | 19.0x34.0 |
| FB22050 <sup>b</sup> Back Window (Heated)(1 Holes) .....                           | 23.0x59.5 |
| FB21979 <sup>b</sup> Back Window (Heated)(1 Holes)(Solar) .....                    | 23.0x59.5 |

<sup>a</sup> May Require Two Person Installation  
<sup>b</sup> Urethane,Dam,Primer - 2 Tubes  
<sup>c</sup> Fast-Cure Urethane/Dam/Primer - Quantity 2

**Solara 2 Door Convertible ..... 2006-2008**

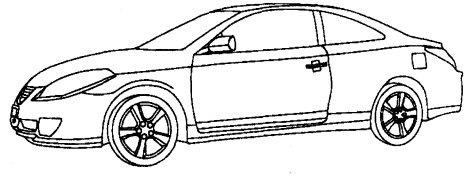

|   |           |
|---|-----------|
| FW02438 <sup>a b</sup> Windshield (Solar) ..... | 37.0x59.0 |
| FD22154-55 Door F/R-L (Solar) .....             | 18.0x42.0 |
| FQ22372-73 Quarter R-L (Solar) .....            |           |

<sup>a</sup> Urethane,Dam,Primer - 2 Tubes  
<sup>b</sup> Fast-Cure Urethane/Dam/Primer - Quantity 2

**Solara 2 Door Coupe ..... 2006-2008**

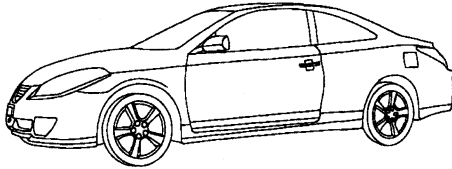

|                               |  |                  |
|-------------------------------|--|------------------|
| <b>FW02438<sup>a</sup></b>    | Windshield (Solar) .....                                     | <b>37.0x59.0</b> |
| <b>FD22154-55</b>             | Door F/R-L (Solar) .....                                     | <b>18.0x42.0</b> |
| <b>FQ22156-57<sup>c</sup></b> | Quarter R-L (Encap)(Solar) .....                             | <b>14.0x30.0</b> |
| <b>FB22231<sup>a</sup></b>    | Back Window (Ant)(Heated)(Solar) (W/Diversity Antenna) ..... | <b>32.0x49.5</b> |
| <b>FB22158<sup>a</sup></b>    | Back Window (Ant)(Heated)(Solar) .....                       | <b>32.0x49.5</b> |

<sup>a</sup> Urethane,Dam,Primer - 2 Tubes  
<sup>b</sup> Fast-Cure Urethane/Dam/Primer - Quantity 2  
<sup>c</sup> Urethane,Dam,Primer - 1 Tube

**Tacoma Pickup 2 Door Extended Cab ..... 2006-2011**

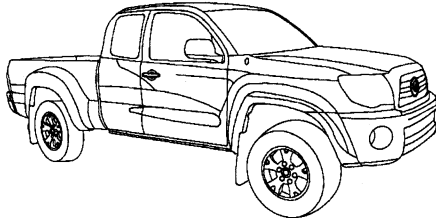

|                               |   |                  |
|-------------------------------|---|------------------|
| <b>FW02500<sup>a</sup></b>    | Windshield (Solar) (W/Third Visor Frit) .....   | <b>29.2x58.7</b> |
| <b>FD22401-02</b>             | Door F/R-L .....  | <b>19.4x32.9</b> |
| <b>FQ22479-80<sup>d</sup></b> | Quarter R-L (Solar) .....   | <b>17.5x17.8</b> |
| <b>FY95050<sup>c</sup></b>    | Back Window (Encap)(Slider)(Solar) (Black Frame, Aftermarket, Power, 3 Panel Encapsulated) .....  | <b>15.5x57.0</b> |
| <b>FY95049<sup>c</sup></b>    | Back Window (Encap)(Slider)(Solar) (Black Frame, Aftermarket, Manual, 3 Panel Encapsulated) ..... | <b>15.5x57.0</b> |
| <b>FB22482<sup>c</sup></b>    | Back Window (Slider)(Solar) (OE) .....  | <b>15.0x55.3</b> |
| <b>FB22481<sup>c</sup></b>    | Back Window (Encap)(Solar) (Stationary) .....   | <b>15.0x55.3</b> |

<sup>a</sup> Urethane,Dam,Primer - 2 Tubes  
<sup>b</sup> Fast-Cure Urethane/Dam/Primer - Quantity 2  
<sup>c</sup> Urethane,Dam,Primer - 1.5 Tubes  
<sup>d</sup> Urethane,Dam,Primer - 1 Tube

**Tacoma Pickup 2 Door Standard Cab ..... 2006-2011**

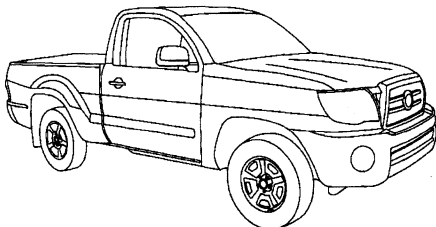

|                            |   |                  |
|----------------------------|---|------------------|
| <b>FW02500<sup>a</sup></b> | Windshield (Solar) (W/Third Visor Frit) .....   | <b>29.2x58.7</b> |
| <b>FD22399-00</b>          | Door F/R-L .....  | <b>19.0x33.3</b> |
| <b>FY95050<sup>c</sup></b> | Back Window (Encap)(Slider)(Solar) (Black Frame, Aftermarket, Power, 3 Panel Encapsulated) .....  | <b>15.5x57.0</b> |
| <b>FY95049<sup>c</sup></b> | Back Window (Encap)(Slider)(Solar) (Black Frame, Aftermarket, Manual, 3 Panel Encapsulated) ..... | <b>15.5x57.0</b> |
| <b>FB22482<sup>c</sup></b> | Back Window (Slider)(Solar) (OE) .....  | <b>15.0x55.3</b> |
| <b>FB22481<sup>c</sup></b> | Back Window (Encap)(Solar) (Stationary) .....   | <b>15.0x55.3</b> |

<sup>a</sup> Urethane,Dam,Primer - 2 Tubes

**Tacoma Pickup (cont.)**

<sup>b</sup> Fast-Cure Urethane/Dam/Primer - Quantity 2  
<sup>c</sup> Urethane,Dam,Primer - 1.5 Tubes

**Tacoma Pickup 4 Door Crew Cab ..... 2006-2011**

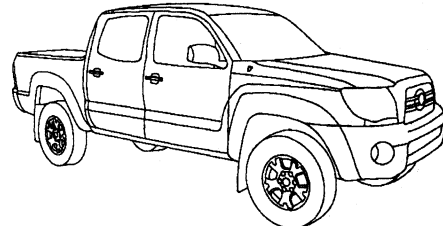

|                            |   |                  |
|----------------------------|---|------------------|
| <b>FW02500<sup>a</sup></b> | Windshield (Solar) (W/Third Visor Frit) .....   | <b>29.2x58.7</b> |
| <b>FD22401-02</b>          | Door F/R-L .....  | <b>19.4x32.9</b> |
| <b>FD22403-04</b>          | Door R/R-L .....  | <b>20.2x27.0</b> |
| <b>FY95050<sup>c</sup></b> | Back Window (Encap)(Slider)(Solar) (Black Frame, Aftermarket, Power, 3 Panel Encapsulated) .....  | <b>15.5x57.0</b> |
| <b>FY95049<sup>c</sup></b> | Back Window (Encap)(Slider)(Solar) (Black Frame, Aftermarket, Manual, 3 Panel Encapsulated) ..... | <b>15.5x57.0</b> |
| <b>FB22482<sup>c</sup></b> | Back Window (Slider)(Solar) (OE) .....  | <b>15.0x55.3</b> |
| <b>FB22481<sup>c</sup></b> | Back Window (Encap)(Solar) (Stationary) .....   | <b>15.0x55.3</b> |

<sup>a</sup> Urethane,Dam,Primer - 2 Tubes  
<sup>b</sup> Fast-Cure Urethane/Dam/Primer - Quantity 2  
<sup>c</sup> Urethane,Dam,Primer - 1.5 Tubes

**Tundra Pickup 2 Door Extended Cab ..... 2006**

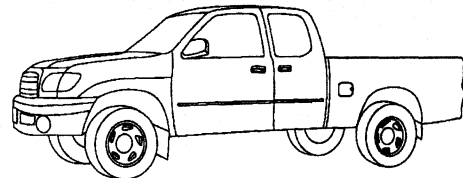

|                            |  |                  |
|----------------------------|--|------------------|
| <b>FW02503<sup>a</sup></b> | Windshield (Solar) (W/Third Visor Frit) .....  | <b>29.9x61.8</b> |
| <b>FD20545-46</b>          | Door F/R-L (Solar) .....   | <b>21.5x33.5</b> |
| <b>FQ20547-48</b>          | Quarter R-L (Encap)(3 Holes)(Solar) (Movable, Rear Access Door) .....                              | <b>19.2x19.5</b> |
| <b>FY95046<sup>c</sup></b> | Back Window (Encap)(Slider) (Black Frame, Aftermarket, Curved, Manual, 3 Panel Encapsulated) ..... | <b>16.5x60.0</b> |
| <b>FY95045<sup>c</sup></b> | Back Window (Encap)(Slider)(Solar) (Aftermarket, Power, Curved, 3 Panel Encapsulated) .....        | <b>16.5x60.0</b> |
| <b>FY95044<sup>c</sup></b> | Back Window (Encap)(Slider)(Solar) (Aftermarket, Curved, Manual, 3 Panel Encapsulated) .....       | <b>16.5x60.0</b> |
| <b>FB22422<sup>d</sup></b> | Back Window (Slider)(Solar) (OE, Power) .....  | <b>17.0x61.0</b> |
| <b>FB21091<sup>d</sup></b> | Back Window (Slider)(Solar) (OE, Manual) .....   | <b>17.0x61.0</b> |
| <b>FB20549<sup>c</sup></b> | Back Window (Encap)(Solar) (Stationary) .....  | <b>16.0x59.0</b> |

<sup>a</sup> Urethane,Dam,Primer - 2 Tubes  
<sup>b</sup> Fast-Cure Urethane/Dam/Primer - Quantity 2  
<sup>c</sup> Urethane,Dam,Primer - 1.5 Tubes  
<sup>d</sup> Foam Core Butyl Tape - Quantity 1.5

**Tundra Pickup 2 Door Standard Cab ..... 2007-2011**

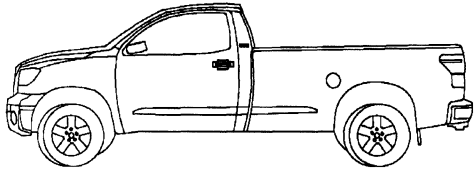

|   |                  |
|---|------------------|
| <b>FW03218<sup>b c d</sup></b> Windshield (Heated)(Solar) (W/Third Visor Frit, Heated Wiper Park Area) (From 02/22/2010) (10-11) ....   | <b>35.8x65.8</b> |
| <b>FW03217<sup>a c d</sup></b> Windshield (Solar) (W/Third Visor Frit) (From 02/22/2010) (10-11) .....                                  | <b>35.8x65.8</b> |
| <b>FW02724<sup>c d</sup></b> Windshield (Heated)(Solar) (W/Third Visor Frit, Infrared Interlayer, Heated Wiper Park Area) (07-10) ..... | <b>35.8x65.8</b> |
| <b>FW02723<sup>c d</sup></b> Windshield (Solar) (W/Third Visor Frit, Infrared Interlayer) (07-10) .....                                 | <b>35.8x65.8</b> |
| <b>FW02722<sup>c d</sup></b> Windshield (Heated)(Solar) (W/Third Visor Frit, Heated Wiper Park Area) .....                              | <b>35.8x65.8</b> |
| <b>FW02721<sup>c d</sup></b> Windshield (Solar) (W/Third Visor Frit) .....  | <b>35.8x65.8</b> |
| <b>FD23321-22</b> Door F/R-L (Solar) .....  | <b>22.8x44.8</b> |
| <b>FB24714</b> Back Window C (Slider)(Solar) (Power) (09-11) .....  |                  |
| <b>FY95054<sup>e</sup></b> Back Window (Encap)(Slider)(Solar) (Black Frame, Aftermarket, Power, 3 Panel Encapsulated) .....             | <b>17.3x62.1</b> |
| <b>FY95053<sup>e</sup></b> Back Window (Encap)(Slider)(Solar) (Black Frame, Aftermarket, Manual, 3 Panel Encapsulated) .....            | <b>17.3x62.1</b> |
| <b>FB24713<sup>e</sup></b> Back Window (Slider)(Solar) (OE, Power, W/O Center Sliding Glass) (09-11) .....                              | <b>17.3x62.1</b> |
| <b>FB23335<sup>e</sup></b> Back Window (Encap)(Slider)(Solar) (OE, Manual) ...  | <b>17.3x62.1</b> |
| <b>FB23334<sup>e</sup></b> Back Window (Encap)(Solar) (Stationary) .....  | <b>17.3x62.1</b> |

<sup>a</sup> Paint Band Different Than FW02721GBY  
<sup>b</sup> Paint Band Different Than FW02722GBY  
<sup>c</sup> Urethane,Dam,Primer - 2 Tubes  
<sup>d</sup> Fast-Cure Urethane/Dam/Primer - Quantity 2  
<sup>e</sup> Urethane,Dam,Primer - 1.5 Tubes

**Tundra Pickup 2 Door Standard Cab ..... 2006**

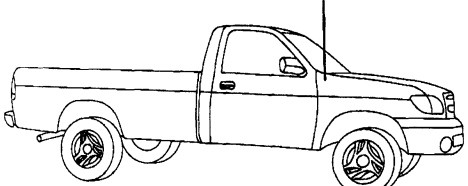

|   |                  |
|---|------------------|
| <b>FW02503<sup>a b</sup></b> Windshield (Solar) (W/Third Visor Frit) .....  | <b>29.9x61.8</b> |
| <b>FD20545-46</b> Door F/R-L (Solar) .....  | <b>21.5x33.5</b> |
| <b>FY95046<sup>c</sup></b> Back Window (Encap)(Slider) (Black Frame, Aftermarket, Curved, Manual, 3 Panel Encapsulated) ..... | <b>16.5x60.0</b> |
| <b>FY95045<sup>c</sup></b> Back Window (Encap)(Slider)(Solar) (Aftermarket, Power, Curved, 3 Panel Encapsulated) .....        | <b>16.5x60.0</b> |
| <b>FY95044<sup>c</sup></b> Back Window (Encap)(Slider)(Solar) (Aftermarket, Curved, Manual, 3 Panel Encapsulated) .....       | <b>16.5x60.0</b> |
| <b>FB22422<sup>d</sup></b> Back Window (Slider)(Solar) (OE, Power) .....  | <b>17.0x61.0</b> |
| <b>FB21091<sup>d</sup></b> Back Window (Slider)(Solar) (OE, Manual) .....   | <b>17.0x61.0</b> |
| <b>FB20549<sup>c</sup></b> Back Window (Encap)(Solar) (Stationary) .....  | <b>16.0x59.0</b> |

<sup>a</sup> Urethane,Dam,Primer - 2 Tubes  
<sup>b</sup> Fast-Cure Urethane/Dam/Primer - Quantity 2  
<sup>c</sup> Urethane,Dam,Primer - 1.5 Tubes  
<sup>d</sup> Foam Core Butyl Tape - Quantity 1.5

**Tundra Pickup 4 Door Crew Cab ..... 2007-2011**

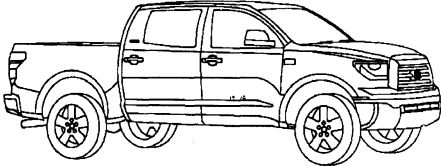

|   |                  |
|---|------------------|
| <b>FW03218<sup>b c d</sup></b> Windshield (Heated)(Solar) (W/Third Visor Frit, Heated Wiper Park Area) (From 02/22/2010) (10-11) ...    | <b>35.8x65.8</b> |
| <b>FW03217<sup>a c d</sup></b> Windshield (Solar) (W/Third Visor Frit) (From 02/22/2010) (10-11) .....                                  | <b>35.8x65.8</b> |
| <b>FW02724<sup>c d</sup></b> Windshield (Heated)(Solar) (W/Third Visor Frit, Infrared Interlayer, Heated Wiper Park Area) (07-10) ..... | <b>35.8x65.8</b> |
| <b>FW02723<sup>c d</sup></b> Windshield (Solar) (W/Third Visor Frit, Infrared Interlayer) (07-10) .....                                 | <b>35.8x65.8</b> |
| <b>FW02722<sup>c d</sup></b> Windshield (Heated)(Solar) (W/Third Visor Frit, Heated Wiper Park Area) .....                              | <b>35.8x65.8</b> |
| <b>FW02721<sup>c d</sup></b> Windshield (Solar) (W/Third Visor Frit) .....  | <b>35.8x65.8</b> |
| <b>FD23323-24</b> Door F/R-L (Solar) .....  | <b>23.0x35.0</b> |
| <b>FD23325-26</b> Door R/R-L (Solar) .....  | <b>23.5x34.8</b> |
| <b>FY95054<sup>e</sup></b> Back Window (Encap)(Slider)(Solar) (Black Frame, Aftermarket, Power, 3 Panel Encapsulated) .....             | <b>17.3x62.1</b> |
| <b>FY95053<sup>e</sup></b> Back Window (Encap)(Slider)(Solar) (Black Frame, Aftermarket, Manual, 3 Panel Encapsulated) .....            | <b>17.3x62.1</b> |
| <b>FB23336</b> Back Window (Heated)(Solar) (Power Drop Down) ...  | <b>17.3x62.1</b> |
| <b>FB23335<sup>e</sup></b> Back Window (Encap)(Slider)(Solar) (OE, Manual) ..   | <b>17.3x62.1</b> |
| <b>FB23334<sup>e</sup></b> Back Window (Encap)(Solar) (Stationary) .....  | <b>17.3x62.1</b> |

<sup>a</sup> Paint Band Different Than FW02721GBY  
<sup>b</sup> Paint Band Different Than FW02722GBY  
<sup>c</sup> Urethane,Dam,Primer - 2 Tubes  
<sup>d</sup> Fast-Cure Urethane/Dam/Primer - Quantity 2  
<sup>e</sup> Urethane,Dam,Primer - 1.5 Tubes

**Tundra Pickup 4 Door Crew Cab ..... 2006**

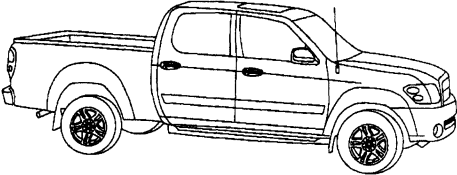

|  |                  |
|--|------------------|
| <b>FW02508<sup>a b</sup></b> Windshield (Solar) (W/Third Visor Frit) ..... | <b>28.3x61.4</b> |
| <b>FD21322-23</b> Door F/R-L (Solar) .....                                 | <b>24.0x37.0</b> |
| <b>FD22261-62</b> Door R/R-L (Solar) .....                                 | <b>22.0x29.5</b> |
| <b>FB22263</b> Back Window (Heated)(Solar) (Power Drop Down) ...           | <b>20.5x54.5</b> |

<sup>a</sup> Urethane,Dam,Primer - 2 Tubes  
<sup>b</sup> Fast-Cure Urethane/Dam/Primer - Quantity 2

**Tundra Pickup 4 Door Extended Cab ..... 2007-2011**

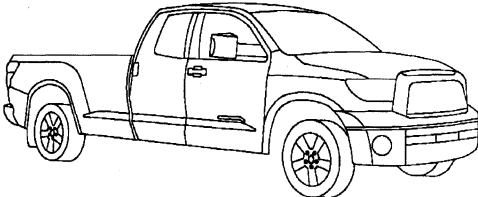

|  |                  |
|--|------------------|
| <b>FW03218<sup>b c d</sup></b> Windshield (Heated)(Solar) (W/Third Visor Frit, Heated Wiper Park Area) (From 02/22/2010) (10-11) ... | <b>35.8x65.8</b> |
|--|------------------|



| <b>Tundra Pickup (cont.)</b>  |           |
|---|-----------|
| FW03217 <sup>a c d</sup> Windshield (Solar) (W/Third Visor Frit) (From 02/22/2010) (10-11) .....                                  | 35.8x65.8 |
| FW02724 <sup>c d</sup> Windshield (Heated)(Solar) (W/Third Visor Frit, Infrared Interlayer, Heated Wiper Park Area) (07-10) ..... | 35.8x65.8 |
| FW02723 <sup>c d</sup> Windshield (Solar) (W/Third Visor Frit, Infrared Interlayer) (07-10) .....                                 | 35.8x65.8 |
| FW02722 <sup>c d</sup> Windshield (Heated)(Solar) (W/Third Visor Frit, Heated Wiper Park Area) .....                              | 35.8x65.8 |
| FW02721 <sup>c d</sup> Windshield (Solar) (W/Third Visor Frit) .....  | 35.8x65.8 |
| FD23323-24 Door F/R-L (Solar) .....   | 23.0x35.0 |
| FD23483-84 Door R/R-L (Solar) .....   | 21.0x22.5 |
| FB24714 Back Window C (Slider)(Solar) (Power) (09-11) .....   |           |
| FY95054 <sup>e</sup> Back Window (Encap)(Slider)(Solar) (Black Frame, Aftermarket, Power, 3 Panel Encapsulated) .....             | 17.3x62.1 |
| FY95053 <sup>e</sup> Back Window (Encap)(Slider)(Solar) (Black Frame, Aftermarket, Manual, 3 Panel Encapsulated) .....            | 17.3x62.1 |
| FB24713 <sup>e</sup> Back Window (Slider)(Solar) (OE, Power, W/O Center Sliding Glass) (09-11) .....                              | 17.3x62.1 |
| FB23335 <sup>e</sup> Back Window (Encap)(Slider)(Solar) (OE, Manual) ...  | 17.3x62.1 |
| FB23334 <sup>e</sup> Back Window (Encap)(Solar) (Stationary) .....  | 17.3x62.1 |

<sup>a</sup> Paint Band Different Than FW02721GBY  
<sup>b</sup> Paint Band Different Than FW02722GBY  
<sup>c</sup> Urethane,Dam,Primer - 2 Tubes  
<sup>d</sup> Fast-Cure Urethane/Dam/Primer - Quantity 2  
<sup>e</sup> Urethane,Dam,Primer - 1.5 Tubes

**Venza 4 Door Utility ..... 2009-2011**

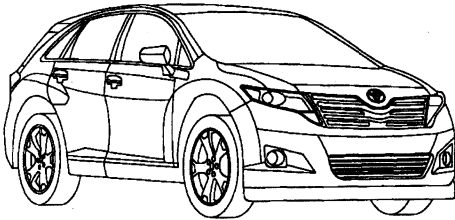

|  |           |
|--|-----------|
| FW03015 <sup>a b</sup> Windshield (Heated)(Solar) (W/Third Visor Frit, W/Panoramic Glass Roof, Heated Wiper Park Area) ..... | 39.9x61.2 |
| FW03014 <sup>a b</sup> Windshield (Solar) (W/Third Visor Frit, W/Panoramic Glass Roof) .....                                 | 39.9x61.2 |
| FW03004 <sup>a b</sup> Windshield (Heated)(Solar) (W/Third Visor Frit, Heated Wiper Park Area) .....                         | 41.1x61.2 |
| FW03003 <sup>a b</sup> Windshield (Solar) (W/Third Visor Frit) .....   | 41.1x61.2 |
| FD24035-36 Door F/R-L (Solar) .....  | 20.8x37.5 |
| FD24037-38 Door R/R-L (Solar) .....  | 20.0x31.0 |
| FQ24039-40 <sup>d</sup> Quarter R-L (Encap)(Solar) .....   | 15.0x22.0 |
| FV24033-34 Vent F/R-L (Encap)(Solar) .....   | 9.0x11.0  |
| FB24041 <sup>c</sup> Back Window (Ant)(Heated)(1 Holes)(Solar) .....   | 23.0x58.0 |

<sup>a</sup> Urethane,Dam,Primer - 2 Tubes  
<sup>b</sup> Fast-Cure Urethane/Dam/Primer - Quantity 2  
<sup>c</sup> Urethane,Dam,Primer - 1.5 Tubes  
<sup>d</sup> Urethane,Dam,Primer - 1 Tube

**Yaris 2 Door Hatchback ..... 2006-2011**

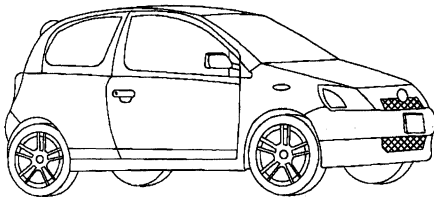

|  |           |
|--|-----------|
| FW02614 <sup>a b</sup> Windshield (W/Third Visor Frit) ..... | 36.3x52.5 |
| FD22907-08 Door F/R-L (Solar) .....                          | 22.5x38.8 |
| FQ22909-10 <sup>d</sup> Quarter R-L (Solar) .....            | 17.0x30.5 |

| <b>Yaris (cont.)</b>                                   |           |
|--|-----------|
| FV22878-79 Vent F/R-L (Solar) .....                    | 4.0x 8.0  |
| FB22911 <sup>c</sup> Back Window (Heated)(Solar) ..... | 22.0x51.0 |
| FB22886 <sup>c</sup> Back Window (Solar) .....         | 22.0x51.0 |

<sup>a</sup> Urethane,Dam,Primer - 2 Tubes  
<sup>b</sup> Fast-Cure Urethane/Dam/Primer - Quantity 2  
<sup>c</sup> Urethane,Dam,Primer - 1.5 Tubes  
<sup>d</sup> Urethane,Dam,Primer - 1 Tube

**Yaris 4 Door Hatchback..... 2006-2011**

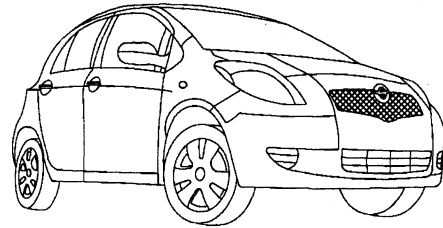

|  |           |
|--|-----------|
| FW02614 <sup>a b</sup> Windshield (W/Third Visor Frit) ..... | 36.3x52.5 |
| FD22880-81 Door F/R-L (Solar) .....                          | 22.3x32.8 |
| FD22882-83 Door R/R-L (Solar) .....                          | 18.5x21.3 |
| FV22878-79 Vent F/R-L (Solar) .....                          | 4.0x 8.0  |
| FV22884-85 Vent R/R-L (Solar) .....                          | 10.5x14.5 |
| FB22911 <sup>c</sup> Back Window (Heated)(Solar) .....       | 22.0x51.0 |
| FB22886 <sup>c</sup> Back Window (Solar) .....               | 22.0x51.0 |

<sup>a</sup> Urethane,Dam,Primer - 2 Tubes  
<sup>b</sup> Fast-Cure Urethane/Dam/Primer - Quantity 2  
<sup>c</sup> Urethane,Dam,Primer - 1.5 Tubes

**Yaris 4 Door Sedan ..... 2007-2011**

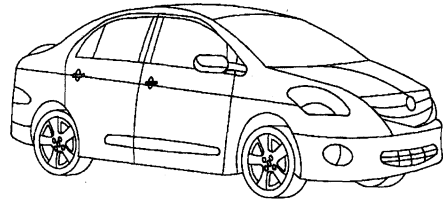

|  |           |
|--|-----------|
| FW02682 <sup>a b</sup> Windshield (W/Third Visor Frit) ..... | 36.3x52.4 |
| FD22941-42 Door F/R-L (Solar) .....                          | 20.8x36.3 |
| FD22943-44 Door R/R-L (Solar) .....                          | 18.0x23.8 |
| FV22945-46 Vent R/R-L (Solar) .....                          | 10.0x11.5 |
| FB23157 <sup>c</sup> Back Window (Solar) .....               | 25.0x48.0 |
| FB22947 <sup>c</sup> Back Window (Ant)(Heated)(Solar) .....  | 25.0x48.0 |

<sup>a</sup> Urethane,Dam,Primer - 2 Tubes  
<sup>b</sup> Fast-Cure Urethane/Dam/Primer - Quantity 2  
<sup>c</sup> Urethane,Dam,Primer - 1.5 Tubes

**Amarok 4 Door Crew Cab (MEXICO Only)..... 2011**

|  |  |
|--|--|
| FW03331 <sup>b</sup> Windshield (Solar) (Mexico Only) .....          |  |
| FD24866-67 Door F/R-L (Solar) (Mexico Only) .....                    |  |
| FD24868-69 Door R/R-L (Solar) (Mexico Only) .....                    |  |
| FV24870-71 Vent R/R-L (Solar) (Mexico Only) .....                    |  |
| FB24872 <sup>a</sup> Back Window (Heated)(Solar) (Mexico Only) ..... |  |

<sup>a</sup> High Modulus Urethane,Dam,Primer - 1.5 Tubes  
<sup>b</sup> High Modulus Urethane,Dam,Primer - 2 Tubes

|   |           |
|---|-----------|
| <b>Bora 4 Door Sedan (MEXICO Only)..... 2006-2010</b>   |           |
| FW03002 <sup>a d</sup> Windshield (Solar) (W/Third Visor Frit, Aftermarket) (From 1K_8_058144) (08-10) .....    | 36.9x56.4 |
| FW02977 <sup>b d</sup> Windshield (Solar) (PAAS System, W/Third Visor Frit) (From 1K_8_058144) (08-10) .....    | 36.9x56.4 |
| FW02796 <sup>a d</sup> Windshield (Solar) (W/Third Visor Frit, Aftermarket, Rain Sensor) .....                  | 36.9x56.4 |
| FW02795 <sup>a d</sup> Windshield (Solar) (W/Third Visor Frit, Aftermarket) (To 1K_8_058143) (06-08) .....      | 36.9x56.4 |
| FW02526 <sup>b d</sup> Windshield (Solar) (PAAS System, W/Third Visor Frit, Rain Sensor) .....                  | 36.9x56.4 |
| FW02525 <sup>b d</sup> Windshield (Solar) (PAAS System, W/Third Visor Frit) (To 1K_8_058143) (06-08) .....      | 36.9x56.4 |
| FD22542-43 Door F/R-L (Solar) .....   | 20.0x37.3 |
| FD22544-45 Door R/R-L (1 Holes)(Solar) .....  | 19.8x24.3 |
| FV22546-47 Vent R/R-L (Solar) .....   | 10.6x16.7 |
| FB22548 <sup>c</sup> Back Window (Ant)(Heated)(Solar) (PAAS System, W/Brake Light Bracket, W/GPS Antenna) ..... | 30.0x48.0 |
| <sup>a</sup> Not On Production Vehicles   |           |
| <sup>b</sup> On Production Vehicles   |           |
| <sup>c</sup> High Modulus Urethane,Dam,Primer - 1.5 Tubes   |           |
| <sup>d</sup> High Modulus Urethane,Dam,Primer - 2 Tubes   |           |

|   |           |
|---|-----------|
| <b>Bora 4 Door Station Wagon (MEXICO Only)..... 2008-2010</b>                 |           |
| FW03002 <sup>a d</sup> Windshield (Solar) (W/Third Visor Frit, Aftermarket)   | 36.9x56.4 |
| FW02977 <sup>b d</sup> Windshield (Solar) (PAAS System, W/Third Visor Frit)   | 36.9x56.4 |
| FD22542-43 Door F/R-L (Solar) .....   | 20.0x37.3 |
| FD23592-93 Door R/R-L (Solar) .....   | 19.6x24.0 |
| FQ23946 <sup>e</sup> Quarter L (Ant)(Encap)(Solar) (Chrome Moulding) ....     | 16.5x22.0 |
| FQ23597 <sup>e</sup> Quarter L (Ant)(Encap)(Solar) (Black Moulding) .....     | 16.5x22.0 |
| FQ23945 <sup>e</sup> Quarter R (Encap)(Solar) (Chrome Moulding) .....         | 16.5x22.0 |
| FQ23596 <sup>e</sup> Quarter R (Encap)(Solar) (Black Moulding) .....          | 16.5x22.0 |
| FV23594-95 Vent R/R-L (Solar) .....   | 9.3x16.1  |
| FB23598 <sup>c</sup> Back Window (Heated)(1 Holes)(Solar) (PAAS System) ..... | 20.0x51.0 |
| <sup>a</sup> Not On Production Vehicles                                       |           |
| <sup>b</sup> On Production Vehicles   |           |
| <sup>c</sup> High Modulus Urethane,Dam,Primer - 1.5 Tubes                     |           |
| <sup>d</sup> High Modulus Urethane,Dam,Primer - 2 Tubes                       |           |
| <sup>e</sup> High Modulus Urethane,Dam,Primer - 1 Tube                        |           |

|   |           |
|---|-----------|
| <b>Crafter 144" WB Van (MEXICO Only)..... 2007-2010</b>   |           |
| DW01721 <sup>a c</sup> Windshield (Heated)(Solar) (W/Third Visor Frit, Rain/Light Sensor, Fully Heated) ..... | 42.0x70.0 |
| DW01720 <sup>a c</sup> Windshield (Solar) (W/Third Visor Frit, Rain/Light Sensor) .....                       | 42.0x70.0 |
| DW01719 <sup>a c</sup> Windshield (Solar) (W/Third Visor Frit) .....  | 42.0x70.0 |
| DD11394-95 Door F/R-L (Solar) .....   | 30.3x56.0 |
| DD11396-97 <sup>b</sup> Door R/R-L (Solar) (Sliding Cargo Door) .....   | 30.3x56.0 |
| DD11398-99 <sup>b</sup> Side R-L (Solar) (Body Side) .....  | 30.3x55.3 |
| DQ11406-07 Quarter F/R-L (Solar) (W/O Sliding Cargo Door, Stationary) .....                                   | 30.3x56.0 |
| DQ11404-05 Quarter F/R-L (Solar) (Stationary, W/Sliding Cargo Door) .....                                     | 30.3x56.0 |
| DQ11410-11 Quarter R/R-L (Solar) (W/O Sliding Cargo Door, Movable) .....                                      | 30.3x56.0 |
| DQ11408-09 Quarter R/R-L (Solar) (Movable, W/Sliding Cargo Door) .....  | 30.3x56.0 |
| DQ11402-03 Quarter R-L (Solar) (W/O Sliding Cargo Door, One-Piece) .....                                      | 30.3x64.5 |
| DQ11400-01 Quarter R-L (Solar) (One-Piece, W/Sliding Cargo Door) .....  | 27.8x64.3 |
| DV11392-93 Vent F/R-L (Solar) .....   | 10.0x25.3 |
| DB11420-21 <sup>d</sup> Back Window R-L (Heated)(Solar) .....   | 31.5x33.0 |
| DB11418-19 <sup>d</sup> Back Window R-L (Solar) .....   | 31.5x33.0 |
| <sup>a</sup> May Require Two Person Installation  |           |
| <sup>b</sup> High Modulus Non-Conductive Urethane,Dam,Primer - 2 Tubes  |           |
| <sup>c</sup> High Modulus Non-Conductive Urethane,Dam,Primer - 2.5 Tubes                                      |           |

|   |           |
|---|-----------|
| <b>Crafter (cont.)</b>  |           |
| <sup>d</sup> High Modulus Non-Conductive Urethane,Dam,Primer - 1.5 Tubes                                      |           |
| <b>Crafter 170" WB Van (MEXICO Only) ..... 2007-2010</b>  |           |
| DW01721 <sup>a c</sup> Windshield (Heated)(Solar) (W/Third Visor Frit, Rain/Light Sensor, Fully Heated) ..... | 42.0x70.0 |
| DW01720 <sup>a c</sup> Windshield (Solar) (W/Third Visor Frit, Rain/Light Sensor) .....                       | 42.0x70.0 |
| DW01719 <sup>a c</sup> Windshield (Solar) (W/Third Visor Frit) .....  | 42.0x70.0 |
| DD11394-95 Door F/R-L (Solar) .....   | 30.3x56.0 |
| DD11396-97 <sup>b</sup> Door R/R-L (Solar) (Sliding Cargo Door) .....   | 30.3x56.0 |
| DD11398-99 <sup>b</sup> Side R-L (Solar) (Body Side) .....  | 30.3x55.3 |
| DQ11414-15 Quarter F/R-L (Solar) (W/O Sliding Cargo Door) .....   | 30.3x56.0 |
| DQ11412-13 Quarter F/R-L (Solar) (W/Sliding Cargo Door) .....   | 27.8x55.8 |
| DQ11416-17 Quarter R/R-L (Solar) .....  | 30.3x49.5 |
| DV11392-93 Vent F/R-L (Solar) .....   | 10.0x25.3 |
| DB11420-21 <sup>d</sup> Back Window R-L (Heated)(Solar) .....   | 31.5x33.0 |
| DB11418-19 <sup>d</sup> Back Window R-L (Solar) .....   | 31.5x33.0 |
| <sup>a</sup> May Require Two Person Installation  |           |
| <sup>b</sup> High Modulus Non-Conductive Urethane,Dam,Primer - 2 Tubes  |           |
| <sup>c</sup> High Modulus Non-Conductive Urethane,Dam,Primer - 2.5 Tubes                                      |           |
| <sup>d</sup> High Modulus Non-Conductive Urethane,Dam,Primer - 1.5 Tubes                                      |           |

|  |           |
|--|-----------|
| <b>CrossFox 4 Door Hatchback (MEXICO Only)..... 2011</b>               |           |
| FW03280 <sup>b</sup> Windshield (Mexico Only, Rain Sensor) .....       | 36.9x56.4 |
| FW03279 <sup>b</sup> Windshield (Mirror, Mexico Only) .....            | 36.9x56.4 |
| FW03278 <sup>b</sup> Windshield (Mexico Only) .....                    | 36.9x56.4 |
| FD23142-43 Door F/R-L (Mexico Only) .....                              | 19.6x24.0 |
| FD23144-45 Door R/R-L (Mexico Only) .....                              | 19.6x24.0 |
| FV23146-47 Vent R/R-L (Mexico Only) .....                              | 10.6x16.7 |
| FB24715 <sup>a</sup> Back Window (Heated)(1 Holes) (Mexico Only) ..... | 20.0x51.0 |
| <sup>a</sup> High Modulus Urethane,Dam,Primer - 1.5 Tubes              |           |
| <sup>b</sup> High Modulus Urethane,Dam,Primer - 2 Tubes                |           |

|   |           |
|---|-----------|
| <b>CrossFox 4 Door Hatchback (MEXICO Only)..... 2006-2010</b> |           |
| FW02481 <sup>b</sup> Windshield (Ant) (Mexico Only) .....     | 36.9x56.4 |
| FW02480 <sup>b</sup> Windshield (Mexico Only) .....           | 36.9x56.4 |
| FD23142-43 Door F/R-L (Mexico Only) .....                     | 19.6x24.0 |
| FD23144-45 Door R/R-L (Mexico Only) .....                     | 19.6x24.0 |
| FV23146-47 Vent R/R-L (Mexico Only) .....                     | 10.6x16.7 |
| FB22346 <sup>a</sup> Back Window (Heated) (Mexico Only) ..... | 20.0x51.0 |
| FB22345 <sup>a</sup> Back Window (Mexico Only) .....          | 20.0x51.0 |
| <sup>a</sup> High Modulus Urethane,Dam,Primer - 1.5 Tubes     |           |
| <sup>b</sup> High Modulus Urethane,Dam,Primer - 2 Tubes       |           |

|   |           |
|---|-----------|
| <b>Derby 4 Door Sedan (MEXICO Only)..... 2006-2009</b>  |           |
| FW02645 <sup>b</sup> Windshield (Solar) (PAAS System, Mexico Only) .....                                  | 36.9x56.4 |
| FD05441-42 Door F/R-L .....   | 20.5x34.9 |
| FD05443-44 Door R/R-L .....   | 19.4x26.0 |
| FQ05445-46 <sup>c</sup> Quarter R-L (Encap) .....   | 12.1x18.0 |
| FB23025 <sup>a</sup> Back Window (Heated)(Solar) (PAAS System, Mexico Only, High Mount Brake Light) ..... | 30.3x49.5 |
| FB23024 <sup>a</sup> Back Window (Heated)(Solar) (PAAS System, Mexico Only) .....                         | 30.3x49.5 |
| <sup>a</sup> High Modulus Urethane,Dam,Primer - 1.5 Tubes   |           |
| <sup>b</sup> High Modulus Urethane,Dam,Primer - 2 Tubes   |           |
| <sup>c</sup> Encapsulation Lubricant  |           |

**Eos 2 Door Convertible ..... 2006-2011**

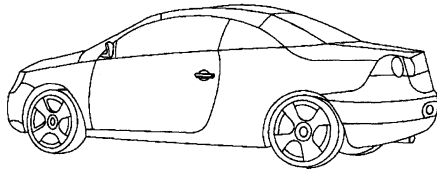

|                              |   |                  |
|------------------------------|---|------------------|
| <b>FW02809<sup>a d</sup></b> | Windshield (W/Third Visor Frit, Aftermarket, Rain Sensor) ..... | <b>37.0x56.0</b> |
| <b>FW02805<sup>a d</sup></b> | Windshield (W/Third Visor Frit, Aftermarket) .....              | <b>37.0x56.0</b> |
| <b>FW02679<sup>b d</sup></b> | Windshield (PAAS System, W/Third Visor Frit, Rain Sensor) ..... | <b>37.0x56.0</b> |
| <b>FW02629<sup>b d</sup></b> | Windshield (PAAS System, W/Third Visor Frit) .....              | <b>37.0x56.0</b> |
| <b>FD22955-56</b>            | Door F/R-L (1 Holes)(Solar) .....                               | <b>21.5x46.0</b> |
| <b>FQ22957-58</b>            | Quarter R-L .....   | <b>15.0x23.5</b> |
| <b>FB22959<sup>c</sup></b>   | Back Window (Encap)(Heated) .....                               | <b>25.5x47.5</b> |

<sup>a</sup> Not On Production Vehicles  
<sup>b</sup> On Production Vehicles  
<sup>c</sup> High Modulus Urethane,Dam,Primer - 1.5 Tubes  
<sup>d</sup> High Modulus Urethane,Dam,Primer - 2 Tubes

**Eurovan MEXICO Mini Van (MEXICO Only)..... 2006-2009**

|                              |  |  |
|------------------------------|--|--|
| <b>FW03143<sup>a b</sup></b> | Windshield (Ant)(Solar) (Mexico Only, Rain Sensor) . |  |
| <b>FW03142<sup>a b</sup></b> | Windshield (Solar) (Mexico Only, Rain Sensor) .....  |  |
| <b>FW03141<sup>b</sup></b>   | Windshield (Solar) (Mexico Only) .....               |  |
| <b>FW02978<sup>b</sup></b>   | Windshield (Ant)(Solar) (Export Only) .....          |  |
| <b>FD24415-16</b>            | Door F/R-L (Solar) (Mexico Only) .....               |  |

<sup>a</sup> Rain Sensor Kit  
<sup>b</sup> High Modulus Urethane,Dam,Primer - 2 Tubes

**GLI 4 Door Sedan ..... 2008-2010**

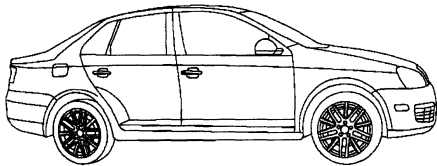

|                              |  |                  |
|------------------------------|--|------------------|
| <b>FW03002<sup>a d</sup></b> | Windshield (Solar) (W/Third Visor Frit, Aftermarket) (From 1K_8_058144) .....              | <b>36.9x56.4</b> |
| <b>FW02977<sup>b d</sup></b> | Windshield (Solar) (PAAS System, W/Third Visor Frit) (From 1K_8_058144) .....              | <b>36.9x56.4</b> |
| <b>FW02796<sup>a d</sup></b> | Windshield (Solar) (W/Third Visor Frit, Aftermarket, Rain Sensor) .....                    | <b>36.9x56.4</b> |
| <b>FW02795<sup>a d</sup></b> | Windshield (Solar) (W/Third Visor Frit, Aftermarket) (To 1K_8_058143) (08) .....           | <b>36.9x56.4</b> |
| <b>FW02526<sup>b d</sup></b> | Windshield (Solar) (PAAS System, W/Third Visor Frit, Rain Sensor) .....                    | <b>36.9x56.4</b> |
| <b>FW02525<sup>b d</sup></b> | Windshield (Solar) (PAAS System, W/Third Visor Frit) (To 1K_8_058143) (08) .....           | <b>36.9x56.4</b> |
| <b>FD22542-43</b>            | Door F/R-L (Solar) .....   | <b>20.0x37.3</b> |
| <b>FD22544-45</b>            | Door R/R-L (1 Holes)(Solar) .....  | <b>19.8x24.3</b> |
| <b>FV22546-47</b>            | Vent R/R-L (Solar) .....   | <b>10.6x16.7</b> |
| <b>FB22548<sup>c</sup></b>   | Back Window (Ant)(Heated)(Solar) (PAAS System, W/Brake Light Bracket, W/GPS Antenna) ..... | <b>30.0x48.0</b> |

<sup>a</sup> Not On Production Vehicles  
<sup>b</sup> On Production Vehicles  
<sup>c</sup> High Modulus Urethane,Dam,Primer - 1.5 Tubes  
<sup>d</sup> High Modulus Urethane,Dam,Primer - 2 Tubes

**GTI 2 Door Hatchback..... 2010-2011**  
**Golf 2 Door Hatchback ..... 2010-2011**

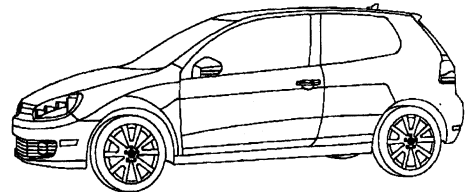

|                               |  |                  |
|-------------------------------|--|------------------|
| <b>FW03187<sup>a c</sup></b>  | Windshield (Solar) (W/Third Visor Frit, Acoustic Inter-layer, Rain Sensor) ..... | <b>37.5x55.5</b> |
| <b>FW03186<sup>c</sup></b>    | Windshield (Solar) (W/Third Visor Frit, Acoustic Inter-layer) .....              | <b>37.5x55.5</b> |
| <b>FD24533-34</b>             | Door F/R-L (Solar) .....   | <b>20.5x45.5</b> |
| <b>FQ24535-36<sup>d</sup></b> | Quarter R-L (Encap)(Solar) .....   | <b>17.5x32.0</b> |
| <b>FB24543<sup>b</sup></b>    | Back Window (Ant)(Heated)(1 Holes)(Solar) .....                                  | <b>16.5x56.0</b> |

<sup>a</sup> Rain Sensor Kit  
<sup>b</sup> High Modulus Urethane,Dam,Primer - 1.5 Tubes  
<sup>c</sup> High Modulus Urethane,Dam,Primer - 2 Tubes  
<sup>d</sup> High Modulus Urethane,Dam,Primer - 1 Tube

**GTI 2 Door Hatchback..... 2006-2009**  
**R32 2 Door Hatchback..... 2007-2009**

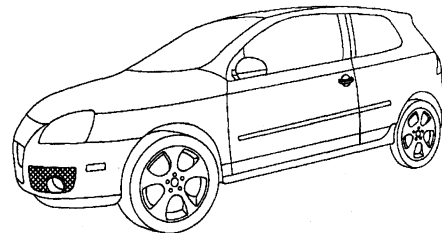

|                               |  |                  |
|-------------------------------|--|------------------|
| <b>FW02901<sup>a d</sup></b>  | Windshield (Solar) (W/Third Visor Frit, Aftermarket) (From 03/01/2006) (06-09) ..... | <b>39.4x57.1</b> |
| <b>FW02882<sup>b d</sup></b>  | Windshield (Solar) (PAAS System, W/Third Visor Frit) (From 03/01/2006) (06-09) ..... | <b>39.4x57.1</b> |
| <b>FW02808<sup>a d</sup></b>  | Windshield (Solar) (W/Third Visor Frit, Aftermarket, Rain Sensor) (06-09) .....      | <b>39.4x57.1</b> |
| <b>FW02807<sup>a d</sup></b>  | Windshield (Solar) (W/Third Visor Frit, Aftermarket) (To 02/28/2006) (06) .....      | <b>39.4x57.1</b> |
| <b>FW02649<sup>b d</sup></b>  | Windshield (Solar) (PAAS System, W/Third Visor Frit, Rain Sensor) (06-09) .....      | <b>39.4x57.1</b> |
| <b>FW02648<sup>b d</sup></b>  | Windshield (Solar) (PAAS System, W/Third Visor Frit) (To 02/28/2006) (06) .....      | <b>39.4x57.1</b> |
| <b>FD22707-08</b>             | Door F/R-L (Solar) (06-09) .....   | <b>21.0x45.3</b> |
| <b>FQ22709-10<sup>e</sup></b> | Quarter R-L (Encap)(Solar) (06-09) .....   | <b>18.0x31.0</b> |
| <b>FB22713<sup>c</sup></b>    | Back Window (Ant)(Heated)(1 Holes)(Solar) (PAAS System, W/TV Antenna) (06-09) .....  | <b>19.0x52.0</b> |
| <b>FB22712<sup>c</sup></b>    | Back Window (Ant)(Heated)(1 Holes)(Solar) (PAAS System) (06-09) .....                | <b>19.0x52.0</b> |
| <b>FB22711<sup>c</sup></b>    | Back Window (Heated)(1 Holes)(Solar) (PAAS System) (06-09) .....                     | <b>19.0x52.0</b> |

<sup>a</sup> Not On Production Vehicles  
<sup>b</sup> On Production Vehicles  
<sup>c</sup> High Modulus Urethane,Dam,Primer - 1.5 Tubes  
<sup>d</sup> High Modulus Urethane,Dam,Primer - 2 Tubes  
<sup>e</sup> High Modulus Urethane,Dam,Primer - 1 Tube

|                                    |                  |
|------------------------------------|------------------|
| <b>GTI 4 Door Hatchback</b> .....  | <b>2010-2011</b> |
| <b>Golf 4 Door Hatchback</b> ..... | <b>2010-2011</b> |

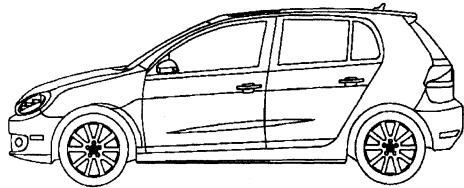

|   |                  |
|---|------------------|
| <b>FW03187<sup>a</sup> c</b> Windshield (Solar) (W/Third Visor Frit, Acoustic Inter-layer, Rain Sensor) ..... | <b>37.5x55.5</b> |
| <b>FW03186<sup>c</sup></b> Windshield (Solar) (W/Third Visor Frit, Acoustic Inter-layer) .....                | <b>37.5x55.5</b> |
| <b>FD24537-38</b> Door F/R-L (Solar) .....  | <b>20.5x37.8</b> |
| <b>FD24539-40</b> Door R/R-L (1 Holes)(Solar) .....   | <b>21.5x25.5</b> |
| <b>FV24541-42</b> Vent R/R-L (Encap)(Solar) .....   | <b>11.0x14.5</b> |
| <b>FB24543<sup>b</sup></b> Back Window (Ant)(Heated)(1 Holes)(Solar) .....                                    | <b>16.5x56.0</b> |

<sup>a</sup> Rain Sensor Kit  
<sup>b</sup> High Modulus Urethane,Dam,Primer - 1.5 Tubes  
<sup>c</sup> High Modulus Urethane,Dam,Primer - 2 Tubes

|                                   |                  |
|-----------------------------------|------------------|
| <b>GTI 4 Door Hatchback</b> ..... | <b>2007-2009</b> |
|-----------------------------------|------------------|

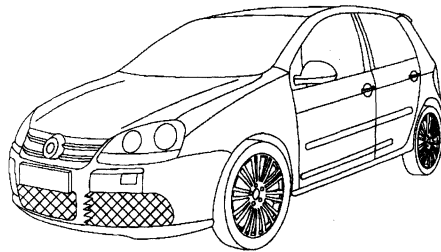

|  |                  |
|--|------------------|
| <b>FW02901<sup>a</sup> d</b> Windshield (Solar) (W/Third Visor Frit, Aftermarket) .....                | <b>39.4x57.1</b> |
| <b>FW02882<sup>b</sup> d</b> Windshield (Solar) (PAAS System, W/Third Visor Frit) .....                | <b>39.4x57.1</b> |
| <b>FW02808<sup>a</sup> d</b> Windshield (Solar) (W/Third Visor Frit, Aftermarket, Rain Sensor) .....   | <b>39.4x57.1</b> |
| <b>FW02649<sup>b</sup> d</b> Windshield (Solar) (PAAS System, W/Third Visor Frit, Rain Sensor) .....   | <b>39.4x57.1</b> |
| <b>FD23746-47</b> Door F/R-L (Solar) .....   | <b>22.0x37.3</b> |
| <b>FD22716-17</b> Door R/R-L (Solar) .....   | <b>22.3x25.0</b> |
| <b>FV22718-19</b> Vent R/R-L (Solar) .....   | <b>10.5x15.0</b> |
| <b>FB22713<sup>c</sup></b> Back Window (Ant)(Heated)(1 Holes)(Solar) (PAAS System, W/TV Antenna) ..... | <b>19.0x52.0</b> |
| <b>FB22712<sup>c</sup></b> Back Window (Ant)(Heated)(1 Holes)(Solar) (PAAS System) .....               | <b>19.0x52.0</b> |
| <b>FB22711<sup>c</sup></b> Back Window (Heated)(1 Holes)(Solar) (PAAS System) .....                    | <b>19.0x52.0</b> |

<sup>a</sup> Not On Production Vehicles  
<sup>b</sup> On Production Vehicles  
<sup>c</sup> High Modulus Urethane,Dam,Primer - 1.5 Tubes  
<sup>d</sup> High Modulus Urethane,Dam,Primer - 2 Tubes

|   |                  |
|---|------------------|
| <b>Gol 4 Door Hatchback (MEXICO Only)</b> ..... | <b>2009-2010</b> |
|---|------------------|

|  |  |
|--|--|
| <b>FW03096<sup>b</sup></b> Windshield (Mexico Only) .....                                    |  |
| <b>FD24274-75</b> Door F/R-L (Solar) (Mexico Only) .....                                     |  |
| <b>FD24276-77</b> Door R/R-L (Solar) (Mexico Only) .....                                     |  |
| <b>FV24278-79</b> Vent R/R-L (Encap)(Solar) (Mexico Only) .....                              |  |
| <b>FB24283<sup>a</sup></b> Back Window (Heated)(1 Holes)(Solar) (Mexico Only, W/Wiper) ..... |  |
| <b>FB24282<sup>a</sup></b> Back Window (Heated)(Solar) (Mexico Only) .....                   |  |
| <b>FB24281<sup>a</sup></b> Back Window (Solar) (Mexico Only) .....                           |  |

<sup>a</sup> High Modulus Urethane,Dam,Primer - 1.5 Tubes  
<sup>b</sup> High Modulus Urethane,Dam,Primer - 2 Tubes

|   |                  |
|---|------------------|
| <b>Gol 4 Door Sedan (MEXICO Only)</b> ..... | <b>2009-2010</b> |
|---|------------------|

|  |  |
|--|--|
| <b>FW03096<sup>b</sup></b> Windshield (Mexico Only) .....  |  |
| <b>FD24274-75</b> Door F/R-L (Solar) (Mexico Only) .....   |  |
| <b>FD24276-77</b> Door R/R-L (Solar) (Mexico Only) .....   |  |
| <b>FV24278-79</b> Vent R/R-L (Encap)(Solar) (Mexico Only) .....                                      |  |
| <b>FB24782<sup>a</sup></b> Back Window (Heated)(Solar) (Mexico Only, W/Deck Mount Brake Light) ..... |  |
| <b>FB24280<sup>a</sup></b> Back Window (Heated)(Solar) (Mexico Only) .....                           |  |

<sup>a</sup> High Modulus Urethane,Dam,Primer - 1.5 Tubes  
<sup>b</sup> High Modulus Urethane,Dam,Primer - 2 Tubes

|   |                  |
|---|------------------|
| <b>Golf CITY 4 Door Hatchback</b> ..... | <b>2007-2010</b> |
|   | (CANADA Only)    |

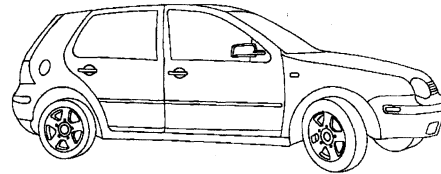

|  |                  |
|--|------------------|
| <b>FW02843<sup>b</sup></b> Windshield (PAAS System, W/Third Visor Frit, W/ V.I.N. Notch, Mirror Mount) ..... | <b>35.9x58.4</b> |
| <b>FW02115<sup>b</sup></b> Windshield (PAAS System, W/V.I.N. Notch, Mirror Mount) .....                      | <b>35.9x58.4</b> |
| <b>FD20622-23</b> Door F/R-L .....   | <b>23.2x37.4</b> |
| <b>FD20624-25</b> Door R/R-L .....   | <b>21.9x23.0</b> |
| <b>FV20626-27</b> Vent R/R-L .....   | <b>11.6x14.4</b> |
| <b>FB24044<sup>a</sup></b> Back Window (Heated)(1 Holes) (PAAS System, W/ Wiper) (From 1J 7 010001) .....    |                  |
| <b>FB20628<sup>a</sup></b> Back Window (Heated)(1 Holes) (PAAS System, W/ Wiper) (To 1J 7 010000) (07) ..... | <b>18.8x51.3</b> |

<sup>a</sup> High Modulus Urethane,Dam,Primer - 1.5 Tubes  
<sup>b</sup> High Modulus Urethane,Dam,Primer - 2 Tubes

|                                    |             |
|------------------------------------|-------------|
| <b>Golf 4 Door Hatchback</b> ..... | <b>2006</b> |
|------------------------------------|-------------|

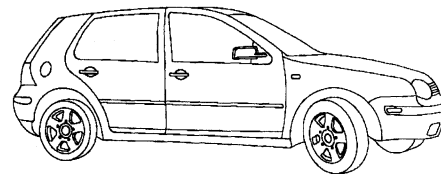

|  |                  |
|--|------------------|
| <b>FW03009<sup>d</sup></b> Windshield (Export Only) .....  | <b>35.9x58.4</b> |
| <b>FW02781<sup>a</sup> d</b> Windshield (Aftermarket, Rain Sensor, W/V.I.N. Notch, Mirror Mount) ..... | <b>35.9x58.4</b> |
| <b>FW02780<sup>a</sup> d</b> Windshield (Aftermarket, W/V.I.N. Notch, Mirror Mount) .....              | <b>35.9x58.4</b> |
| <b>FW02117<sup>b</sup> d</b> Windshield (PAAS System, Rain Sensor, W/V.I.N. Notch, Mirror Mount) ..... | <b>35.9x58.4</b> |
| <b>FW02115<sup>b</sup> d</b> Windshield (PAAS System, W/V.I.N. Notch, Mirror Mount) .....              | <b>35.9x58.4</b> |
| <b>FD20622-23</b> Door F/R-L .....   | <b>23.2x37.4</b> |
| <b>FD20624-25</b> Door R/R-L .....   | <b>21.9x23.0</b> |
| <b>FV20626-27</b> Vent R/R-L .....   | <b>11.6x14.4</b> |
| <b>FB20628<sup>c</sup></b> Back Window (Heated)(1 Holes) (PAAS System, W/ Wiper) .....                 | <b>18.8x51.3</b> |

<sup>a</sup> Not On Production Vehicles  
<sup>b</sup> On Production Vehicles  
<sup>c</sup> High Modulus Urethane,Dam,Primer - 1.5 Tubes  
<sup>d</sup> High Modulus Urethane,Dam,Primer - 2 Tubes

**Golf 4 Door Station Wagon ..... 2010-2011  
(CANADA Only)**



|                            |  |                  |
|----------------------------|--|------------------|
| <b>FW03002<sup>a</sup></b> | Windshield (Solar) (W/Third Visor Frit, Aftermarket) | <b>36.9x56.4</b> |
| <b>FW02977<sup>b</sup></b> | Windshield (Solar) (PAAS System, W/Third Visor Frit) | <b>36.9x56.4</b> |
| <b>FD22542-43</b>          | Door F/R-L (Solar)                                   | <b>20.0x37.3</b> |
| <b>FD23592-93</b>          | Door R/R-L (Solar)                                   | <b>19.6x24.0</b> |
| <b>FQ23946<sup>e</sup></b> | Quarter L (Ant)(Encap)(Solar) (Chrome Moulding)      | <b>16.5x22.0</b> |
| <b>FQ23597<sup>e</sup></b> | Quarter L (Ant)(Encap)(Solar) (Black Moulding)       | <b>16.5x22.0</b> |
| <b>FQ23945<sup>e</sup></b> | Quarter R (Encap)(Solar) (Chrome Moulding)           | <b>16.5x22.0</b> |
| <b>FQ23596<sup>e</sup></b> | Quarter R (Encap)(Solar) (Black Moulding)            | <b>16.5x22.0</b> |
| <b>FV23594-95</b>          | Vent R/R-L (Solar)                                   | <b>9.3x16.1</b>  |
| <b>FB23598<sup>e</sup></b> | Back Window (Heated)(1 Holes)(Solar) (PAAS System)   | <b>20.0x51.0</b> |

- <sup>a</sup> Not On Production Vehicles
- <sup>b</sup> On Production Vehicles
- <sup>c</sup> High Modulus Urethane,Dam,Primer - 1.5 Tubes
- <sup>d</sup> High Modulus Urethane,Dam,Primer - 2 Tubes
- <sup>e</sup> High Modulus Urethane,Dam,Primer - 1 Tube

**Jetta 4 Door Sedan ..... 2011**

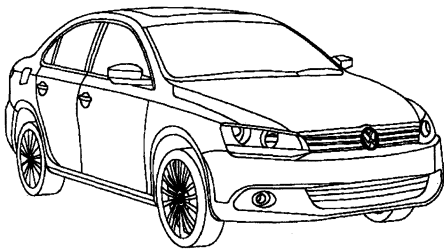

|                            |  |                  |
|----------------------------|--|------------------|
| <b>FW03317<sup>a</sup></b> | Windshield (Solar) (W/Third Visor Frit, Rain Sensor)                 | <b>34.8x56.6</b> |
| <b>FW03316<sup>c</sup></b> | Windshield (Solar) (W/Third Visor Frit)                              | <b>34.8x56.6</b> |
| <b>FD24818-19</b>          | Door F/R-L (Solar)   | <b>19.7x38.8</b> |
| <b>FD24820-21</b>          | Door R/R-L (Solar)   | <b>19.7x38.8</b> |
| <b>FV24822-23</b>          | Vent R/R-L (Solar)   | <b>11.0x12.7</b> |
| <b>FB24826<sup>b</sup></b> | Back Window (Ant)(Heated)(Solar) (W/Diversity Antenna, W/TV Antenna) | <b>33.5x59.8</b> |
| <b>FB24825<sup>b</sup></b> | Back Window (Ant)(Heated)(Solar) (W/Diversity Antenna)               | <b>33.5x59.8</b> |
| <b>FB24824<sup>b</sup></b> | Back Window (Ant)(Heated)(Solar)                                     | <b>33.5x59.8</b> |

- <sup>a</sup> Rain Sensor Kit
- <sup>b</sup> High Modulus Urethane,Dam,Primer - 1.5 Tubes
- <sup>c</sup> High Modulus Urethane,Dam,Primer - 2 Tubes

**Jetta 4 Door Sedan ..... 2006-2010**

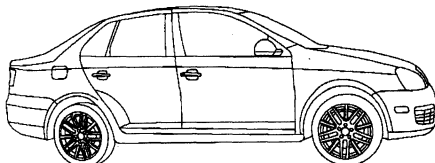

**Jetta (cont.)**

|                            |  |                  |
|----------------------------|--|------------------|
| <b>FW03002<sup>a</sup></b> | Windshield (Solar) (W/Third Visor Frit, Aftermarket) (From 1K_8_058144) (08-10)      | <b>36.9x56.4</b> |
| <b>FW02977<sup>b</sup></b> | Windshield (Solar) (PAAS System, W/Third Visor Frit) (From 1K_8_058144) (08-10)      | <b>36.9x56.4</b> |
| <b>FW02796<sup>a</sup></b> | Windshield (Solar) (W/Third Visor Frit, Aftermarket, Rain Sensor)                    | <b>36.9x56.4</b> |
| <b>FW02795<sup>a</sup></b> | Windshield (Solar) (W/Third Visor Frit, Aftermarket) (To 1K_8_058143) (06-08)        | <b>36.9x56.4</b> |
| <b>FW02526<sup>b</sup></b> | Windshield (Solar) (PAAS System, W/Third Visor Frit, Rain Sensor)                    | <b>36.9x56.4</b> |
| <b>FW02525<sup>b</sup></b> | Windshield (Solar) (PAAS System, W/Third Visor Frit) (To 1K_8_058143) (06-08)        | <b>36.9x56.4</b> |
| <b>FD22542-43</b>          | Door F/R-L (Solar)   | <b>20.0x37.3</b> |
| <b>FD22544-45</b>          | Door R/R-L (1 Holes)(Solar)  | <b>19.8x24.3</b> |
| <b>FV22546-47</b>          | Vent R/R-L (Solar)   | <b>10.6x16.7</b> |
| <b>FB22548<sup>c</sup></b> | Back Window (Ant)(Heated)(Solar) (PAAS System, W/Brake Light Bracket, W/GPS Antenna) | <b>30.0x48.0</b> |

- <sup>a</sup> Not On Production Vehicles
- <sup>b</sup> On Production Vehicles
- <sup>c</sup> High Modulus Urethane,Dam,Primer - 1.5 Tubes
- <sup>d</sup> High Modulus Urethane,Dam,Primer - 2 Tubes

**Jetta CITY 4 Door Sedan ..... 2007-2010  
(CANADA Only)**

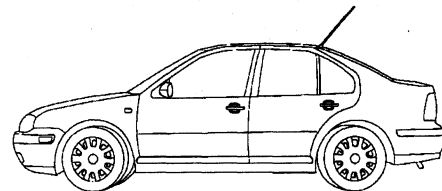

|                            |   |                  |
|----------------------------|---|------------------|
| <b>FW02843<sup>a</sup></b> | Windshield (PAAS System, W/Third Visor Frit, W/ V.I.N. Notch, Mirror Mount) | <b>35.9x58.4</b> |
| <b>FW02115<sup>a</sup></b> | Windshield (PAAS System, W/V.I.N. Notch, Mirror Mount)                      | <b>35.9x58.4</b> |
| <b>FD20611-12</b>          | Door F/R-L  | <b>23.2x37.4</b> |
| <b>FD20613-14</b>          | Door R/R-L  | <b>23.6x24.8</b> |
| <b>FV20615-16</b>          | Vent R/R-L  | <b>15.0x17.0</b> |
| <b>FB20617<sup>a</sup></b> | Back Window (Heated) (PAAS System, Brake Light-Bottom)                      | <b>33.5x59.8</b> |

- <sup>a</sup> High Modulus Urethane,Dam,Primer - 2 Tubes

**Jetta MEXICO 4 Door Sedan ..... 2010**

|                            |  |                  |
|----------------------------|--|------------------|
| <b>FW03317<sup>a</sup></b> | Windshield (Solar) (W/Third Visor Frit, Rain Sensor)                 | <b>34.8x56.6</b> |
| <b>FW03316<sup>c</sup></b> | Windshield (Solar) (W/Third Visor Frit)                              | <b>34.8x56.6</b> |
| <b>FD24818-19</b>          | Door F/R-L (Solar)   | <b>19.7x38.8</b> |
| <b>FD24820-21</b>          | Door R/R-L (Solar)   | <b>19.7x38.8</b> |
| <b>FV24822</b>             | Vent R/R (Solar)   | <b>11.0x12.7</b> |
| <b>FB24826<sup>b</sup></b> | Back Window (Ant)(Heated)(Solar) (W/Diversity Antenna, W/TV Antenna) | <b>33.5x59.8</b> |
| <b>FB24825<sup>b</sup></b> | Back Window (Ant)(Heated)(Solar) (W/Diversity Antenna)               | <b>33.5x59.8</b> |
| <b>FB24824<sup>b</sup></b> | Back Window (Ant)(Heated)(Solar)                                     | <b>33.5x59.8</b> |

- <sup>a</sup> Rain Sensor Kit
- <sup>b</sup> High Modulus Urethane,Dam,Primer - 1.5 Tubes
- <sup>c</sup> High Modulus Urethane,Dam,Primer - 2 Tubes

**Jetta 4 Door Station Wagon ..... 2008-2010**



|                              |  |                  |
|------------------------------|--|------------------|
| <b>FW03002<sup>a,d</sup></b> | Windshield (Solar) (W/Third Visor Frit, Aftermarket) | <b>36.9x56.4</b> |
| <b>FW02977<sup>b,d</sup></b> | Windshield (Solar) (PAAS System, W/Third Visor Frit) | <b>36.9x56.4</b> |
| <b>FD22542-43</b>            | Door F/R-L (Solar)                                   | <b>20.0x37.3</b> |
| <b>FD23592-93</b>            | Door R/R-L (Solar)                                   | <b>19.6x24.0</b> |
| <b>FQ23946<sup>e</sup></b>   | Quarter L (Ant)(Encap)(Solar) (Chrome Moulding)      | <b>16.5x22.0</b> |
| <b>FQ23597<sup>e</sup></b>   | Quarter L (Ant)(Encap)(Solar) (Black Moulding)       | <b>16.5x22.0</b> |
| <b>FQ23945<sup>e</sup></b>   | Quarter R (Encap)(Solar) (Chrome Moulding)           | <b>16.5x22.0</b> |
| <b>FQ23596<sup>e</sup></b>   | Quarter R (Encap)(Solar) (Black Moulding)            | <b>16.5x22.0</b> |
| <b>FV23594-95</b>            | Vent R/R-L (Solar)                                   | <b>9.3x16.1</b>  |
| <b>FB23598<sup>c</sup></b>   | Back Window (Heated)(1 Holes)(Solar) (PAAS System)   | <b>20.0x51.0</b> |

<sup>a</sup> Not On Production Vehicles  
<sup>b</sup> On Production Vehicles  
<sup>c</sup> High Modulus Urethane,Dam,Primer - 1.5 Tubes  
<sup>d</sup> High Modulus Urethane,Dam,Primer - 2 Tubes  
<sup>e</sup> High Modulus Urethane,Dam,Primer - 1 Tube

**Jetta 4 Door Station Wagon ..... 2006**

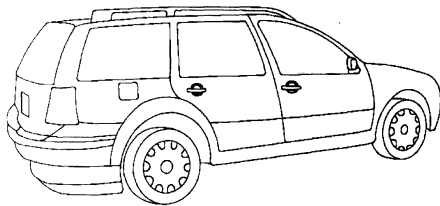

|                               |   |                  |
|-------------------------------|---|------------------|
| <b>FW03009<sup>d</sup></b>    | Windshield (Export Only)  | <b>35.9x58.4</b> |
| <b>FW02781<sup>a,d</sup></b>  | Windshield (Aftermarket, Rain Sensor, W/V.I.N. Notch, Mirror Mount) | <b>35.9x58.4</b> |
| <b>FW02780<sup>a,d</sup></b>  | Windshield (Aftermarket, W/V.I.N. Notch, Mirror Mount)              | <b>35.9x58.4</b> |
| <b>FW02117<sup>b,d</sup></b>  | Windshield (PAAS System, Rain Sensor, W/V.I.N. Notch, Mirror Mount) | <b>35.9x58.4</b> |
| <b>FW02115<sup>b,d</sup></b>  | Windshield (PAAS System, W/V.I.N. Notch, Mirror Mount)              | <b>35.9x58.4</b> |
| <b>FD20611-12</b>             | Door F/R-L  | <b>23.2x37.4</b> |
| <b>FD21393-94</b>             | Door R/R-L (1 Holes)  | <b>22.0x22.8</b> |
| <b>FQ21397-98<sup>e</sup></b> | Quarter R-L (Encap)   | <b>18.0x31.0</b> |
| <b>FV21395-96</b>             | Vent R/R-L  | <b>7.3x18.0</b>  |
| <b>FB21399<sup>c</sup></b>    | Back Window (Heated)(1 Holes) (PAAS System)                         | <b>20.0x48.0</b> |

<sup>a</sup> Not On Production Vehicles  
<sup>b</sup> On Production Vehicles  
<sup>c</sup> High Modulus Urethane,Dam,Primer - 1.5 Tubes  
<sup>d</sup> High Modulus Urethane,Dam,Primer - 2 Tubes  
<sup>e</sup> High Modulus Urethane,Dam,Primer - 1 Tube

**Lupo 2 Door Hatchback (MEXICO Only)..... 2006-2009**

|                            |                                    |  |
|----------------------------|------------------------------------|--|
| <b>FW02481<sup>b</sup></b> | Windshield (Ant) (Mexico Only)     |  |
| <b>FW02480<sup>b</sup></b> | Windshield (Mexico Only)           |  |
| <b>FD22341-42</b>          | Door F/R-L (Mexico Only)           |  |
| <b>FQ22343-44</b>          | Quarter R-L (Mexico Only)          |  |
| <b>FB22346<sup>a</sup></b> | Back Window (Heated) (Mexico Only) |  |

**Lupo (cont.)**

|                            |  |  |
|----------------------------|--|--|
| <b>FB22345<sup>a</sup></b> | Back Window (Mexico Only)                    |  |
| <sup>a</sup>               | High Modulus Urethane,Dam,Primer - 1.5 Tubes |  |
| <sup>b</sup>               | High Modulus Urethane,Dam,Primer - 2 Tubes   |  |

**Lupo 4 Door Hatchback (MEXICO Only) ..... 2006-2009**

|                            |  |  |
|----------------------------|--|--|
| <b>FW02481<sup>b</sup></b> | Windshield (Ant) (Mexico Only)               |  |
| <b>FW02480<sup>b</sup></b> | Windshield (Mexico Only)                     |  |
| <b>FD23142-43</b>          | Door F/R-L (Mexico Only)                     |  |
| <b>FD23144-45</b>          | Door R/R-L (Mexico Only)                     |  |
| <b>FV23146-47</b>          | Vent R/R-L (Mexico Only)                     |  |
| <b>FB22346<sup>a</sup></b> | Back Window (Heated) (Mexico Only)           |  |
| <b>FB22345<sup>a</sup></b> | Back Window (Mexico Only)                    |  |
| <sup>a</sup>               | High Modulus Urethane,Dam,Primer - 1.5 Tubes |  |
| <sup>b</sup>               | High Modulus Urethane,Dam,Primer - 2 Tubes   |  |

**New Beetle 2 Door Convertible ..... 2006-2010**

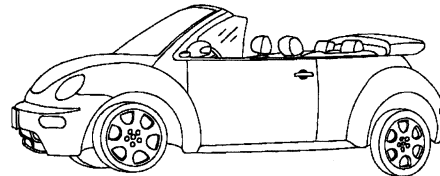

|                              |  |                  |
|------------------------------|--|------------------|
| <b>FW03040<sup>c</sup></b>   | Windshield (Ant)(Solar) (PAAS System, W/Third Visor Frit, Rain Sensor) (07-10) | <b>32.0x55.5</b> |
| <b>FW03039<sup>c</sup></b>   | Windshield (Ant)(Solar) (PAAS System, W/Third Visor Frit) (07-10)              | <b>32.0x55.5</b> |
| <b>FW02794<sup>c</sup></b>   | Windshield (Ant)(Solar) (Aftermarket, Rain Sensor) (06)                        | <b>32.0x55.5</b> |
| <b>FW02791<sup>a,c</sup></b> | Windshield (Ant)(Solar) (Aftermarket) (06)                                     | <b>32.0x55.5</b> |
| <b>FW02515<sup>b,c</sup></b> | Windshield (Ant)(Solar) (PAAS System, Rain Sensor) (06)                        | <b>32.0x55.5</b> |
| <b>FW02386<sup>b,c</sup></b> | Windshield (Ant)(Solar) (PAAS System) (06)                                     | <b>32.0x55.5</b> |
| <b>FD21915-16</b>            | Door F/R-L (1 Holes)(Solar)  | <b>21.0x39.5</b> |
| <b>FQ21917-18</b>            | Quarter R-L (Encap)(Solar)   | <b>19.0x19.5</b> |
| <b>FB23112</b>               | Back Window (Heated) (Aftermarket Only)  | <b>16.8x32.0</b> |

<sup>a</sup> Not On Production Vehicles  
<sup>b</sup> On Production Vehicles  
<sup>c</sup> High Modulus Urethane,Dam,Primer - 2 Tubes

**New Beetle 2 Door Hatchback ..... 2006-2010**

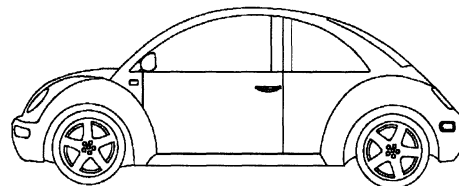

|                               |   |                  |
|-------------------------------|---|------------------|
| <b>FW02787<sup>a,d</sup></b>  | Windshield (Aftermarket, Rain Sensor)         | <b>37.8x57.9</b> |
| <b>FW02777<sup>a,d</sup></b>  | Windshield (Aftermarket)                      | <b>37.8x57.9</b> |
| <b>FW02289<sup>b,d</sup></b>  | Windshield (PAAS System, Rain Sensor)         | <b>37.8x57.9</b> |
| <b>FW02072<sup>b,d</sup></b>  | Windshield (PAAS System)                      | <b>37.8x57.9</b> |
| <b>FD20385-86</b>             | Door F/R-L                                    | <b>22.2x41.7</b> |
| <b>FQ20387-88<sup>c</sup></b> | Quarter R-L (Encap)                           | <b>19.2x45.0</b> |
| <b>FB20817<sup>c</sup></b>    | Back Window (Heated) (PAAS System, W/Spoiler) | <b>29.5x43.5</b> |
| <b>FB20389<sup>c</sup></b>    | Back Window (Heated) (PAAS System)            | <b>35.4x45.1</b> |

<sup>a</sup> Not On Production Vehicles  
<sup>b</sup> On Production Vehicles  
<sup>c</sup> High Modulus Urethane,Dam,Primer - 1.5 Tubes

**New Beetle (cont.)**

<sup>d</sup> High Modulus Urethane,Dam,Primer - 2 Tubes

**Passat 4 Door Sedan ..... 2006-2011**

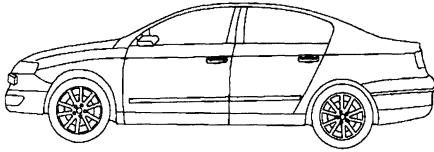

|                                |   |                  |
|--------------------------------|---|------------------|
| <b>FW03259<sup>a c d</sup></b> | Windshield (Solar) (Aftermarket, Rain Sensor) (07-11)                       | <b>36.4x55.8</b> |
| <b>FW02875<sup>b d</sup></b>   | Windshield (Solar) (Acoustic Interlayer, Rain Sensor) (From 120001) (07-11) | <b>36.4x55.8</b> |
| <b>FW02874<sup>b d</sup></b>   | Windshield (Solar) (Acoustic Interlayer) (From 120001) (07-11)              | <b>36.4x55.8</b> |
| <b>FW02865<sup>b d</sup></b>   | Windshield (Solar) (From 120001) (07-11)                                    | <b>36.4x55.8</b> |
| <b>FW02613<sup>b d</sup></b>   | Windshield (Solar) (Rain Sensor) (To 120000) (06-07)                        | <b>36.4x55.8</b> |
| <b>FW02612<sup>b d</sup></b>   | Windshield (Solar) (To 120000) (06-07)                                      | <b>36.4x55.8</b> |
| <b>FD22866-67</b>              | Door F/R-L  | <b>20.0x39.0</b> |
| <b>FD22868-69</b>              | Door R/R-L (1 Holes)  | <b>21.8x26.8</b> |
| <b>FV22870-71</b>              | Vent R/R-L  | <b>11.3x13.8</b> |
| <b>FB22872<sup>d</sup></b>     | Back Window (Ant)(Heated)   | <b>32.5x50.8</b> |

<sup>a</sup> Not On Production Vehicles  
<sup>b</sup> On Production Vehicles  
<sup>c</sup> Rain Sensor Kit  
<sup>d</sup> High Modulus Urethane,Dam,Primer - 2 Tubes

**Passat 4 Door Station Wagon..... 2006-2011**

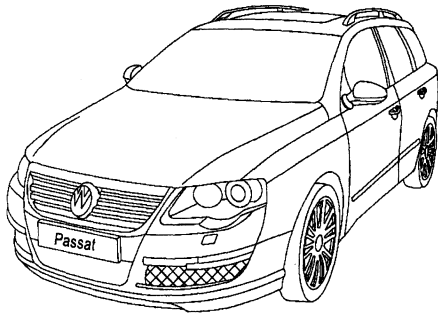

|                                |   |                  |
|--------------------------------|---|------------------|
| <b>FW03259<sup>a c e</sup></b> | Windshield (Solar) (Aftermarket, Rain Sensor) (07-11)                       | <b>36.4x55.8</b> |
| <b>FW02875<sup>b e</sup></b>   | Windshield (Solar) (Acoustic Interlayer, Rain Sensor) (From 120001) (07-11) | <b>36.4x55.8</b> |
| <b>FW02874<sup>b e</sup></b>   | Windshield (Solar) (Acoustic Interlayer) (07-11)                            | <b>36.4x55.8</b> |
| <b>FW02865<sup>b e</sup></b>   | Windshield (Solar) (From 120001) (07-11)                                    | <b>36.4x55.8</b> |
| <b>FW02613<sup>b e</sup></b>   | Windshield (Solar) (Rain Sensor) (To 120000) (06-07)                        | <b>36.4x55.8</b> |
| <b>FW02612<sup>b e</sup></b>   | Windshield (Solar) (To 120000) (06-07)                                      | <b>36.4x55.8</b> |
| <b>FD22866-67</b>              | Door F/R-L  | <b>20.0x39.0</b> |
| <b>FD22873-74</b>              | Door R/R-L (1 Holes)  | <b>22.3x29.3</b> |
| <b>FQ22875-76<sup>f</sup></b>  | Quarter R-L (Encap)   | <b>14.0x28.0</b> |
| <b>FB22877<sup>d</sup></b>     | Back Window (Heated)(1 Holes) (W/Wiper)                                     | <b>19.8x53.5</b> |

<sup>a</sup> Not On Production Vehicles  
<sup>b</sup> On Production Vehicles  
<sup>c</sup> Rain Sensor Kit  
<sup>d</sup> High Modulus Urethane,Dam,Primer - 1.5 Tubes  
<sup>e</sup> High Modulus Urethane,Dam,Primer - 2 Tubes  
<sup>f</sup> High Modulus Urethane,Dam,Primer - 1 Tube

**Passat CC 4 Door Sedan ..... 2009-2011**

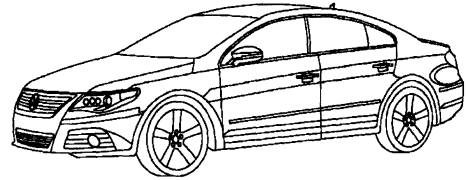

|                                |  |                  |
|--------------------------------|--|------------------|
| <b>FW03273<sup>a c e</sup></b> | Windshield (Solar) (W/Lane Departure Warning System, Aftermarket, Rain Sensor)         | <b>34.4x56.9</b> |
| <b>FW03272<sup>a c e</sup></b> | Windshield (Solar) (Aftermarket, Rain Sensor)  | <b>34.4x56.9</b> |
| <b>FW03091<sup>b e</sup></b>   | Windshield (Solar) (Acoustic Interlayer, W/Lane Departure Warning System, Rain Sensor) | <b>34.4x56.9</b> |
| <b>FW03090<sup>b e</sup></b>   | Windshield (Solar) (Acoustic Interlayer, Rain Sensor)                                  | <b>34.4x56.9</b> |
| <b>FD24248-49</b>              | Door F/R-L (1 Holes)(Solar)  | <b>23.1x35.0</b> |
| <b>FD24250-51</b>              | Door R/R-L (1 Holes)(Solar)  | <b>20.8x23.8</b> |
| <b>FV24252-53</b>              | Vent R/R-L (Encap)(Solar)  | <b>10.6x15.2</b> |
| <b>FB24255<sup>d</sup></b>     | Back Window (Ant)(Heated)(Solar) (W/Diversity Antenna)                                 | <b>29.2x51.5</b> |
| <b>FB24254<sup>d</sup></b>     | Back Window (Ant)(Heated)(Solar)   | <b>29.2x51.5</b> |

<sup>a</sup> Not On Production Vehicles  
<sup>b</sup> On Production Vehicles  
<sup>c</sup> Rain Sensor Kit  
<sup>d</sup> High Modulus Urethane,Dam,Primer - 1.5 Tubes  
<sup>e</sup> High Modulus Urethane,Dam,Primer - 2 Tubes

**Phaeton 4 Door Sedan ..... 2006**

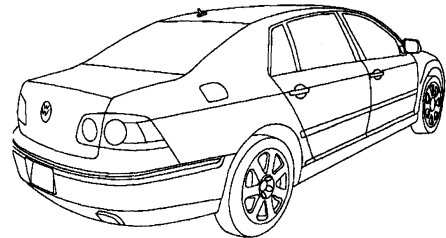

|                              |   |                  |
|------------------------------|---|------------------|
| <b>FW02793<sup>a c</sup></b> | Windshield (Solar) (Aftermarket, Rain Sensor)                 | <b>37.0x60.0</b> |
| <b>FW02462<sup>b c</sup></b> | Windshield (Solar) (PAAS System, Rain Sensor)                 | <b>37.0x60.0</b> |
| <b>FD22302-03</b>            | Door F/R-L (Laminated, Insulated)                             | <b>22.0x34.0</b> |
| <b>FD22300-01</b>            | Door F/R-L (Solar)  | <b>22.0x34.0</b> |
| <b>FD22306-07</b>            | Door R/R-L (Laminated, Insulated)                             | <b>21.0x29.3</b> |
| <b>FD22304-05</b>            | Door R/R-L (Solar)  | <b>21.0x29.3</b> |
| <b>FV22309</b>               | Vent R/L (Solar)  | <b>11.5x14.0</b> |
| <b>FV22310-11</b>            | Vent R/R-L (Laminated, Insulated)                             | <b>11.5x14.0</b> |
| <b>FV22308</b>               | Vent R/R (Solar)  | <b>11.5x14.0</b> |
| <b>FB22312<sup>d</sup></b>   | Back Window (Ant)(Heated) (Laminated, PAAS System, Insulated) | <b>31.0x48.5</b> |

<sup>a</sup> Not On Production Vehicles  
<sup>b</sup> On Production Vehicles  
<sup>c</sup> High Modulus Non-Conductive Urethane,Dam,Primer - 2 Tubes  
<sup>d</sup> High Modulus Non-Conductive Urethane,Dam,Primer - 1.5 Tubes

**Pointer 2 Door Extended Cab (MEXICO Only).... 2006-2007**

|                               |                                       |       |
|-------------------------------|---------------------------------------|-------|
| <b>FW03012<sup>b</sup></b>    | Windshield (Ant) (Mexico Only)        | ..... |
| <b>FW02670<sup>b</sup></b>    | Windshield (Mexico Only)              | ..... |
| <b>FD23158-59</b>             | Door F/R-L (Mexico Only)              | ..... |
| <b>FQ23169-70<sup>a</sup></b> | Quarter R-L (Mexico Only)             | ..... |
| <b>FB23172</b>                | Back Window (Slider) (Mexico Only)    | ..... |
| <b>FB23171<sup>a</sup></b>    | Back Window (Stationary, Mexico Only) | ..... |

<sup>a</sup> High Modulus Urethane,Dam,Primer - 1.5 Tubes  
<sup>b</sup> High Modulus Urethane,Dam,Primer - 2 Tubes

**Pointer 2 Door Hatchback (MEXICO Only)..... 2006-2009**

|   |   |  |
|---|---|--|
| FW03012 <sup>b</sup>                                      | Windshield (Ant) (Mexico Only) .....                        |  |
| FW02670 <sup>b</sup>                                      | Windshield (Mexico Only) .....                              |  |
| FD23191-92  | Door F/R-L (Mexico Only) .....                              |  |
| FQ23167-68  | Quarter R-L (Mexico Only) .....                             |  |
| FB23478 <sup>a</sup>                                      | Back Window (Heated)(1 Holes) (Mexico Only, W/ Wiper) ..... |  |
| FB23166 <sup>a</sup>                                      | Back Window (Mexico Only) .....                             |  |
| <sup>a</sup> High Modulus Urethane,Dam,Primer - 1.5 Tubes |   |  |
| <sup>b</sup> High Modulus Urethane,Dam,Primer - 2 Tubes   |   |  |

**Pointer 4 Door Hatchback (MEXICO Only)..... 2006-2009**

|   |   |  |
|---|---|--|
| FW03012 <sup>b</sup>                                      | Windshield (Ant) (Mexico Only) .....                        |  |
| FW02670 <sup>b</sup>                                      | Windshield (Mexico Only) .....                              |  |
| FD23158-59  | Door F/R-L (Mexico Only) .....                              |  |
| FD23160-61  | Door R/R-L (Mexico Only) .....                              |  |
| FQ23164-65  | Quarter R-L (Mexico Only) .....                             |  |
| FV23162-63  | Vent R/R-L (Mexico Only) .....                              |  |
| FB23478 <sup>a</sup>                                      | Back Window (Heated)(1 Holes) (Mexico Only, W/ Wiper) ..... |  |
| FB23166 <sup>a</sup>                                      | Back Window (Mexico Only) .....                             |  |
| <sup>a</sup> High Modulus Urethane,Dam,Primer - 1.5 Tubes |   |  |
| <sup>b</sup> High Modulus Urethane,Dam,Primer - 2 Tubes   |   |  |

**Polo 4 Door Sedan (MEXICO Only)..... 2006-2007**

|   |   |  |
|---|---|--|
| FW02498 <sup>b</sup>                                      | Windshield (Solar) .....                |  |
| FD22389-90  | Door F/R-L (Mexico Only) .....          |  |
| FD22391-92  | Door R/R-L (Mexico Only) .....          |  |
| FQ22393-94 <sup>a</sup>                                   | Quarter R-L (Encap) (Mexico Only) ..... |  |
| FB22395 <sup>a</sup>                                      | Back Window (Mexico Only) .....         |  |
| <sup>a</sup> High Modulus Urethane,Dam,Primer - 1.5 Tubes |   |  |
| <sup>b</sup> High Modulus Urethane,Dam,Primer - 2 Tubes   |   |  |

**Rabbit 2 Door Hatchback..... 2006-2009**

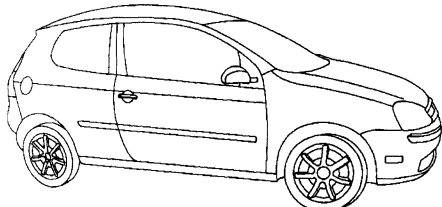

|                         |   |           |
|-------------------------|---|-----------|
| FW02901 <sup>a,d</sup>  | Windshield (Solar) (W/Third Visor Frit, Aftermarket) (From 03/01/2006) .....          | 39.4x57.1 |
| FW02882 <sup>b,d</sup>  | Windshield (Solar) (PAAS System, W/Third Visor Frit) (From 03/01/2006) .....          | 39.4x57.1 |
| FW02808 <sup>a,d</sup>  | Windshield (Solar) (W/Third Visor Frit, Aftermarket, Rain Sensor) .....               | 39.4x57.1 |
| FW02807 <sup>a,d</sup>  | Windshield (Solar) (W/Third Visor Frit, Aftermarket) (To 02/28/2006) (06) .....       | 39.4x57.1 |
| FW02802 <sup>a,d</sup>  | Windshield (Solar) (W/Third Visor Frit, Aftermarket, Solar Coated, Rain Sensor) ..... | 39.4x57.1 |
| FW02649 <sup>b,d</sup>  | Windshield (Solar) (PAAS System, W/Third Visor Frit, Rain Sensor) .....               | 39.4x57.1 |
| FW02648 <sup>b,d</sup>  | Windshield (Solar) (PAAS System, W/Third Visor Frit) (To 02/28/2006) (06) .....       | 39.4x57.1 |
| FW02587 <sup>b,d</sup>  | Windshield (Solar) (PAAS System, W/Third Visor Frit, Solar Coated, Rain Sensor) ..... | 39.4x57.1 |
| FD22707-08              | Door F/R-L (Solar) .....  | 21.0x45.3 |
| FQ22709-10 <sup>e</sup> | Quarter R-L (Encap)(Solar) .....  | 18.0x31.0 |
| FB22713 <sup>c</sup>    | Back Window (Ant)(Heated)(1 Holes)(Solar) (PAAS System, W/TV Antenna) .....           | 19.0x52.0 |

**Rabbit (cont.)**

|   |   |           |
|---|---|-----------|
| FB22712 <sup>c</sup>                                      | Back Window (Ant)(Heated)(1 Holes)(Solar) (PAAS System) ..... | 19.0x52.0 |
| FB22711 <sup>c</sup>                                      | Back Window (Heated)(1 Holes)(Solar) (PAAS System) .....      | 19.0x52.0 |
| <sup>a</sup> Not On Production Vehicles                   |   |           |
| <sup>b</sup> On Production Vehicles                       |   |           |
| <sup>c</sup> High Modulus Urethane,Dam,Primer - 1.5 Tubes |   |           |
| <sup>d</sup> High Modulus Urethane,Dam,Primer - 2 Tubes   |   |           |
| <sup>e</sup> High Modulus Urethane,Dam,Primer - 1 Tube    |   |           |

**Rabbit 4 Door Hatchback..... 2006-2009**

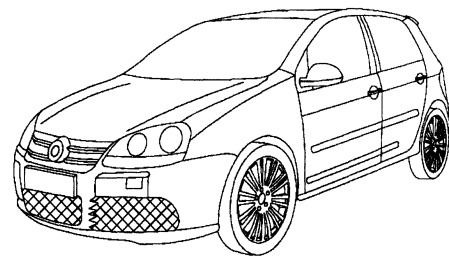

|   |   |           |
|---|---|-----------|
| FW02901 <sup>a,d</sup>                                    | Windshield (Solar) (W/Third Visor Frit, Aftermarket) (From 03/01/2006) .....          | 39.4x57.1 |
| FW02882 <sup>b,d</sup>                                    | Windshield (Solar) (PAAS System, W/Third Visor Frit) (From 03/01/2006) .....          | 39.4x57.1 |
| FW02808 <sup>a,d</sup>                                    | Windshield (Solar) (W/Third Visor Frit, Aftermarket, Rain Sensor) .....               | 39.4x57.1 |
| FW02807 <sup>a,d</sup>                                    | Windshield (Solar) (W/Third Visor Frit, Aftermarket) (To 02/28/2006) (06) .....       | 39.4x57.1 |
| FW02802 <sup>a,d</sup>                                    | Windshield (Solar) (W/Third Visor Frit, Aftermarket, Solar Coated, Rain Sensor) ..... | 39.4x57.1 |
| FW02649 <sup>b,d</sup>                                    | Windshield (Solar) (PAAS System, W/Third Visor Frit, Rain Sensor) .....               | 39.4x57.1 |
| FW02648 <sup>b,d</sup>                                    | Windshield (Solar) (PAAS System, W/Third Visor Frit) (To 02/28/2006) (06) .....       | 39.4x57.1 |
| FW02587 <sup>b,d</sup>                                    | Windshield (Solar) (PAAS System, W/Third Visor Frit, Solar Coated, Rain Sensor) ..... | 39.4x57.1 |
| FD23746-47  | Door F/R-L (Solar) .....  | 22.0x37.3 |
| FD22716-17  | Door R/R-L (Solar) .....  | 22.3x25.0 |
| FV22718-19  | Vent R/R-L (Solar) .....  | 10.5x15.0 |
| FB22713 <sup>c</sup>                                      | Back Window (Ant)(Heated)(1 Holes)(Solar) (PAAS System, W/TV Antenna) .....           | 19.0x52.0 |
| FB22712 <sup>c</sup>                                      | Back Window (Ant)(Heated)(1 Holes)(Solar) (PAAS System) .....                         | 19.0x52.0 |
| FB22711 <sup>c</sup>                                      | Back Window (Heated)(1 Holes)(Solar) (PAAS System) .....                              | 19.0x52.0 |
| <sup>a</sup> Not On Production Vehicles                   |   |           |
| <sup>b</sup> On Production Vehicles                       |   |           |
| <sup>c</sup> High Modulus Urethane,Dam,Primer - 1.5 Tubes |   |           |
| <sup>d</sup> High Modulus Urethane,Dam,Primer - 2 Tubes   |   |           |

**Routan Mini Van..... 2009-2011**

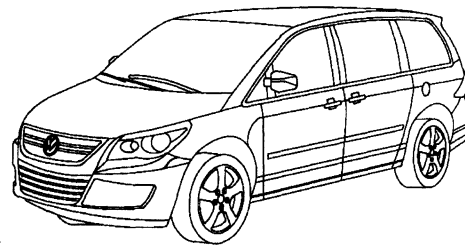

|                          |   |           |
|--------------------------|---|-----------|
| DW01818 <sup>c,d</sup>   | Windshield (Solar) (W/Third Visor Frit) (10-11) ..... | 42.6x66.0 |
| DW01708 <sup>a,c,d</sup> | Windshield (Solar) (W/Third Visor Frit) (09) .....    | 42.6x66.0 |



**Routan (cont.)**

|                            |  |           |
|----------------------------|--|-----------|
| <b>DD11369-70</b>          | Door F/R-L (Solar)                               | 22.3x35.1 |
| <b>DD11373-74</b>          | Door R/R-L (Solar) (Sliding Cargo Door, Movable) | 23.6x36.1 |
| <b>DQ11701-02</b>          | Quarter R/R-L (Solar) (Movable)                  | 16.8x33.5 |
| <b>DB11703<sup>b</sup></b> | Back Window (Heated)(1 Holes)(Solar)             | 20.7x58.4 |

<sup>a</sup> May Require Two Person Installation  
<sup>b</sup> Urethane,Dam,Primer - 1.5 Tubes  
<sup>c</sup> Urethane,Dam,Primer - 2.5 Tubes  
<sup>d</sup> Fast-Cure Urethane/Dam/Primer - Quantity 2.5

**Saveiro 2 Door Extended Cab (MEXICO Only)... 2011**

|                               |  |  |
|-------------------------------|--|--|
| <b>FW03096<sup>b</sup></b>    | Windshield (Mexico Only)                       |  |
| <b>FD24717-18</b>             | Door F/R-L (Mexico Only)                       |  |
| <b>FQ24720-21<sup>a</sup></b> | Quarter R-L (Mexico Only)                      |  |
| <b>FB24723</b>                | Back Window (Slider) (OE, Mexico Only, Manual) |  |
| <b>FB24722<sup>a</sup></b>    | Back Window (Heated) (Mexico Only)             |  |

<sup>a</sup> High Modulus Urethane,Dam,Primer - 1.5 Tubes  
<sup>b</sup> High Modulus Urethane,Dam,Primer - 2 Tubes

**Saveiro 2 Door Standard Cab (MEXICO Only).... 2011**

|                            |                           |  |
|----------------------------|---------------------------|--|
| <b>FW03096<sup>b</sup></b> | Windshield (Mexico Only)  |  |
| <b>FD24717-18</b>          | Door F/R-L (Mexico Only)  |  |
| <b>FB24719<sup>a</sup></b> | Back Window (Mexico Only) |  |

<sup>a</sup> High Modulus Urethane,Dam,Primer - 1.5 Tubes  
<sup>b</sup> High Modulus Urethane,Dam,Primer - 2 Tubes

**Sharan Mini Van (MEXICO Only)..... 2006-2010**

|                               |  |           |
|-------------------------------|--|-----------|
| <b>FW02330<sup>b</sup></b>    | Windshield (Mexico Only)                     | 40.0x55.0 |
| <b>FD21751-52</b>             | Door F/R-L (Mexico Only)                     | 27.0x34.0 |
| <b>FD21753-54</b>             | Door R/R-L (Mexico Only)                     |           |
| <b>FQ21755-56</b>             | Quarter R-L (1 Holes) (Mexico Only, Movable) | 22.0x34.5 |
| <b>FV21749-50<sup>c</sup></b> | Vent F/R-L (Mexico Only)                     | 11.0x21.0 |
| <b>FB21757<sup>a</sup></b>    | Back Window (Heated)(1 Holes) (Mexico Only)  | 22.0x55.0 |

<sup>a</sup> High Modulus Urethane,Dam,Primer - 1.5 Tubes  
<sup>b</sup> High Modulus Urethane,Dam,Primer - 2 Tubes  
<sup>c</sup> High Modulus Urethane,Dam,Primer - 1 Tube

**SportVan 4 Door Station Wagon (MEXICO Only) 2007-2010**

|                               |  |  |
|-------------------------------|--|--|
| <b>FW02481<sup>b</sup></b>    | Windshield (Ant) (Mexico Only)                       |  |
| <b>FW02480<sup>b</sup></b>    | Windshield (Mexico Only)                             |  |
| <b>FD23142-43</b>             | Door F/R-L (Mexico Only)                             |  |
| <b>FD23432-33</b>             | Door R/R-L (Mexico Only)                             |  |
| <b>FQ23436-37<sup>a</sup></b> | Quarter R-L (Mexico Only)                            |  |
| <b>FV23434-35</b>             | Vent R/R-L (Mexico Only)                             |  |
| <b>FB23438<sup>a</sup></b>    | Back Window (Heated)(1 Holes) (Mexico Only, W/Wiper) |  |

<sup>a</sup> High Modulus Urethane,Dam,Primer - 1.5 Tubes  
<sup>b</sup> High Modulus Urethane,Dam,Primer - 2 Tubes

**Tiguan 4 Door Utility..... 2009-2011**

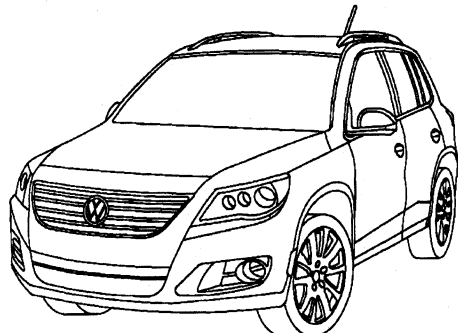

|                               |   |           |
|-------------------------------|---|-----------|
| <b>FW02945<sup>a,c</sup></b>  | Windshield (Solar) (PAAS System, W/Third Visor Frit, Rain Sensor) | 34.0x58.0 |
| <b>FW02944<sup>c</sup></b>    | Windshield (Solar) (PAAS System, W/Third Visor Frit)              |           |
| <b>FD23858-59</b>             | Door F/R-L (Solar)  | 34.0x58.0 |
| <b>FD23860-61</b>             | Door R/R-L (Solar)  | 21.0x36.8 |
| <b>FR23864</b>                | Roof F (Encap)(Solar)   | 20.0x21.0 |
| <b>FR23865</b>                | Roof R (Encap)(Solar)   | 27.0x33.5 |
| <b>FQ23868-69<sup>d</sup></b> | Quarter R-L (Encap)(Solar) (Chrome Moulding)                      | 24.0x33.5 |
| <b>FQ23866-67<sup>d</sup></b> | Quarter R-L (Encap)(Solar) (Black Moulding)                       | 9.0x16.5  |
| <b>FV23862-63</b>             | Vent R/R-L (Encap)(Solar)   | 9.0x16.5  |
| <b>FB23872<sup>b</sup></b>    | Back Window (Ant)(Heated)(1 Holes)(Solar) (W/Wiper)               | 11.0x15.5 |
| <b>FB23871<sup>b</sup></b>    | Back Window (Heated)(Solar)                                       | 20.5x53.5 |
| <b>FB23870<sup>b</sup></b>    | Back Window (Ant)(Heated)(Solar)                                  | 20.5x53.5 |

<sup>a</sup> Rain Sensor Kit  
<sup>b</sup> High Modulus Urethane,Dam,Primer - 1.5 Tubes  
<sup>c</sup> High Modulus Urethane,Dam,Primer - 2 Tubes  
<sup>d</sup> High Modulus Urethane,Dam,Primer - 1 Tube

**Touareg 4 Door Utility..... 2011**

|                               |   |           |
|-------------------------------|---|-----------|
| <b>FW03286<sup>a,c</sup></b>  | Windshield (Heated)(Solar) (PAAS System, W/Third Visor Frit, Acoustic Interlayer, W/Lane Departure Warning System, Rain/Light Sensor) | 36.0x60.9 |
| <b>FW03285<sup>c</sup></b>    | Windshield (Heated)(Solar) (PAAS System, W/Third Visor Frit, Acoustic Interlayer, Rain/Light Sensor)                                  | 36.0x60.9 |
| <b>FD24739-40</b>             | Door F/R-L (Solar) (Laminated)  |           |
| <b>FD24737-38</b>             | Door F/R-L (Solar)  |           |
| <b>FD24741-42</b>             | Door R/R-L (Solar)  |           |
| <b>FQ24743-44<sup>b</sup></b> | Quarter R-L (Encap)(Solar)  |           |
| <b>FV24735-36<sup>b</sup></b> | Vent F/R-L (Encap)(Solar)   |           |
| <b>FB24745<sup>b</sup></b>    | Back Window (Heated)(1 Holes)(Solar) (W/Wiper)  |           |

<sup>a</sup> Rain Sensor Kit  
<sup>b</sup> High Modulus Urethane,Dam,Primer - 1.5 Tubes  
<sup>c</sup> High Modulus Urethane,Dam,Primer - 2 Tubes

**Touareg 4 Door Utility..... 2006-2010**

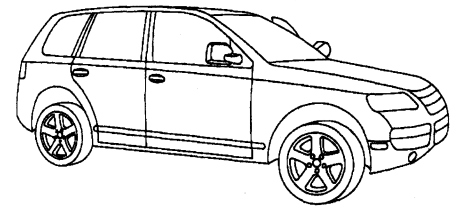

|                              |  |           |
|------------------------------|--|-----------|
| <b>FW03246<sup>a,b</sup></b> | Windshield (Solar) (PAAS System, W/Third Visor Frit) (09-10)                                     | 39.4x62.4 |
| <b>FW02967<sup>a</sup></b>   | Windshield (Heated)(Solar) (PAAS System, W/Third Visor Frit, Rain Sensor) (From 01/2007) (07-10) | 39.4x62.4 |

**Touareg (cont.)**

|                               |  |           |
|-------------------------------|--|-----------|
| <b>FW02966<sup>a b</sup></b>  | Windshield (Heated)(Solar) (PAAS System, W/Third Visor Frit) (From 01/2007) (07-10)                    | 39.4x62.4 |
| <b>FW02965<sup>a</sup></b>    | Windshield (Heated)(Solar) (PAAS System, Rain Sensor) (To 01/2007) (06-07)                             | 39.4x62.4 |
| <b>FW02964<sup>a b</sup></b>  | Windshield (Heated)(Solar) (PAAS System) (To 01/2007) (06-07)  | 39.4x62.4 |
| <b>FW02885<sup>a</sup></b>    | Windshield (Solar) (PAAS System, W/Third Visor Frit, Solar Coated, Rain Sensor) (From 01/2007) (07-10) | 39.4x62.4 |
| <b>FW02884<sup>a</sup></b>    | Windshield (Solar) (PAAS System, W/Third Visor Frit, Rain Sensor) (From 01/2007) (07-10)               | 39.4x62.4 |
| <b>FW02409<sup>a</sup></b>    | Windshield (Solar) (PAAS System, Solar Coated, Rain Sensor) (To 01/2007) (06-07)                       | 39.4x62.4 |
| <b>FW02408<sup>a</sup></b>    | Windshield (Solar) (PAAS System, Rain Sensor) (To 01/2007) (06-07)                                     | 39.4x62.4 |
| <b>FD22093-94</b>             | Door F/R-L (Laminated, Insulated)  | 20.8x30.5 |
| <b>FD22091-92</b>             | Door F/R-L (Solar)   | 20.8x30.5 |
| <b>FD22097-98</b>             | Door R/R-L (Laminated, Insulated)  | 21.0x22.0 |
| <b>FD22095-96</b>             | Door R/R-L (Solar)   | 21.0x22.0 |
| <b>FQ22101-02<sup>c</sup></b> | Quarter R-L (Encap) (Laminated, Insulated)   | 17.5x23.3 |
| <b>FQ22099-00<sup>c</sup></b> | Quarter R-L (Encap)(Solar)   | 17.5x23.3 |
| <b>FB22104</b>                | Back Window (Encap)(Heated)(5 Holes)(Solar)  | 23.0x45.0 |
| <b>FB22103</b>                | Back Window (Ant)(Encap)(Heated)(5 Holes)(Solar)   | 23.0x45.0 |

<sup>a</sup> High Modulus Non-Conductive Urethane,Dam,Primer - 2 Tubes  
<sup>b</sup> Rain Sensor Kit  
<sup>c</sup> High Modulus Urethane,Dam,Primer - 1 Tube

**Transporter Mini Van (MEXICO Only) 2010-2011**

|                               |  |  |
|-------------------------------|--|--|
| <b>FW03143<sup>a c</sup></b>  | Windshield (Ant)(Solar) (Mexico Only, Rain Sensor)   |  |
| <b>FW03142<sup>a c</sup></b>  | Windshield (Solar) (Mexico Only, Rain Sensor)        |  |
| <b>FW03141<sup>c</sup></b>    | Windshield (Solar) (Mexico Only)                     |  |
| <b>FW02978<sup>c</sup></b>    | Windshield (Ant)(Solar) (Export Only)                |  |
| <b>FD24415-16</b>             | Door F/R-L (Solar) (Mexico Only)                     |  |
| <b>FQ24875-76<sup>b</sup></b> | Quarter R-L (Solar) (Mexico Only)                    |  |
| <b>FB24880<sup>b</sup></b>    | Back Window L (Solar) (Mexico Only)                  |  |
| <b>FB24879<sup>b</sup></b>    | Back Window R (Solar) (Mexico Only)                  |  |
| <b>FB24878<sup>b</sup></b>    | Back Window (1 Holes)(Solar) (Mexico Only, W/ Wiper) |  |
| <b>FB24877<sup>b</sup></b>    | Back Window (Solar) (Mexico Only)                    |  |

<sup>a</sup> Rain Sensor Kit  
<sup>b</sup> High Modulus Urethane,Dam,Primer - 1.5 Tubes  
<sup>c</sup> High Modulus Urethane,Dam,Primer - 2 Tubes

**C30 2 Door Hatchback 2007-2011**

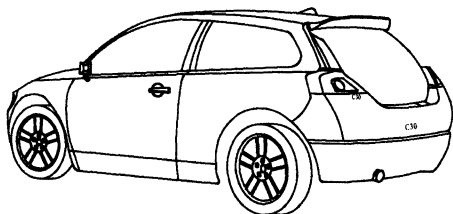

|                               |  |           |
|-------------------------------|--|-----------|
| <b>FW02988<sup>a</sup></b>    | Windshield (Solar) (Rain Sensor)                 | 37.0x59.0 |
| <b>FW02523<sup>a</sup></b>    | Windshield (Solar)                               | 37.0x59.0 |
| <b>FD23587-88</b>             | Door F/R-L (Solar) (Laminated)                   | 17.0x39.0 |
| <b>FD23585-86</b>             | Door F/R-L (Solar)                               | 17.0x39.0 |
| <b>FQ23589-90<sup>b</sup></b> | Quarter R-L (Ant)(Encap)(Solar)                  | 15.5x36.0 |
| <b>FB23591</b>                | Back Window (Ant)(Encap)(Heated)(1 Holes)(Solar) | 29.0x40.5 |

<sup>a</sup> High Modulus Urethane,Dam,Primer - 2 Tubes  
<sup>b</sup> High Modulus Urethane,Dam,Primer - 1 Tube

**C70 2 Door Convertible 2006-2011**

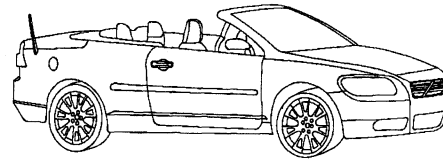

|                            |  |           |
|----------------------------|--|-----------|
| <b>FW02644<sup>b</sup></b> | Windshield (W/Third Visor Frit, Rain Sensor)     | 37.7x57.7 |
| <b>FW02643<sup>b</sup></b> | Windshield (W/Third Visor Frit)                  | 37.7x57.7 |
| <b>FD23014-15</b>          | Door F/R-L (1 Holes)                             | 21.5x42.2 |
| <b>FQ23016-17</b>          | Quarter R-L (3 Holes) (PAAS System Leading Edge) | 20.8x30.0 |
| <b>FB23567<sup>a</sup></b> | Back Window (Heated)(Solar)                      |           |

<sup>a</sup> High Modulus Urethane,Dam,Primer - 1.5 Tubes  
<sup>b</sup> High Modulus Urethane,Dam,Primer - 2 Tubes

**S40 4 Door Sedan 2006-2011**

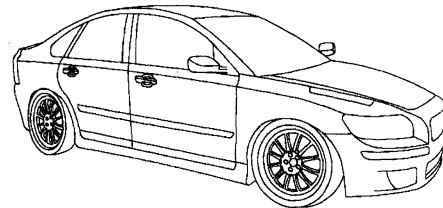

|                               |  |           |
|-------------------------------|--|-----------|
| <b>FW02988<sup>a</sup></b>    | Windshield (Solar) (Rain Sensor) (08-11) | 37.0x59.0 |
| <b>FW02524<sup>a</sup></b>    | Windshield (Solar) (Rain Sensor) (06-07) | 37.0x59.0 |
| <b>FW02523<sup>a</sup></b>    | Windshield (Solar)                       | 37.0x59.0 |
| <b>FD22525-26</b>             | Door F/R-L (Solar) (Laminated)           | 20.3x38.3 |
| <b>FD22523-24</b>             | Door F/R-L (Solar)                       | 20.3x38.3 |
| <b>FD22529-30</b>             | Door R/R-L (Solar) (Laminated)           | 27.5x29.5 |
| <b>FD22527-28</b>             | Door R/R-L (Solar)                       | 27.5x29.5 |
| <b>FQ22531-32<sup>b</sup></b> | Quarter R-L (Encap)(Solar)               | 13.0x17.0 |
| <b>FB22533<sup>a</sup></b>    | Back Window (Ant)(Encap)(Heated)(Solar)  | 34.5x47.0 |

<sup>a</sup> High Modulus Urethane,Dam,Primer - 2 Tubes  
<sup>b</sup> High Modulus Urethane,Dam,Primer - 1 Tube

**S60 4 Door Sedan 2011**

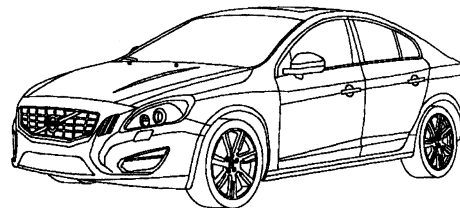

|                              |   |  |
|------------------------------|---|--|
| <b>FW03323<sup>a c</sup></b> | Windshield (W/Collision Warning System, W/Third Visor Frit, W/Lane Departure Warning System, Rain Sensor)           |  |
| <b>FW03322<sup>a c</sup></b> | Windshield (W/Third Visor Frit, W/Lane Departure Warning System, Rain Sensor)                                       |  |
| <b>FW03321<sup>a c</sup></b> | Windshield (Solar) (W/Collision Warning System, W/Third Visor Frit, Acoustic Interlayer, Solar Coated, Rain Sensor) |  |
| <b>FW03320<sup>c</sup></b>   | Windshield (W/Collision Warning System, W/Third Visor Frit)   |  |
| <b>FD24883-84</b>            | Door F/R-L (Hydrophobic Coating)  |  |
| <b>FD24853-54</b>            | Door F/R-L (Laminated, Hydrophobic Coating)   |  |
| <b>FD24835-36</b>            | Door F/R-L  |  |
| <b>FD24855-56</b>            | Door R/R-L (Laminated)  |  |
| <b>FD24837-38</b>            | Door R/R-L  |  |
| <b>FV24857-58</b>            | Vent R/R-L (Laminated)  |  |
| <b>FV24839-40</b>            | Vent R/R-L  |  |

**S60 (cont.)**

**FB24885<sup>b</sup>** Back Window (Ant)(Encap)(Heated) (W/TV Antenna)

**FB24841<sup>b</sup>** Back Window (Ant)(Encap)(Heated) .....

<sup>a</sup> Rain Sensor Kit  
<sup>b</sup> High Modulus Urethane,Dam,Primer - 1.5 Tubes  
<sup>c</sup> High Modulus Urethane,Dam,Primer - 2 Tubes

---

**S60 4 Door Sedan ..... 2006-2009**

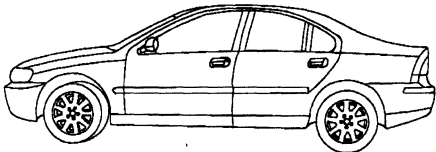

**FW02322<sup>a</sup>** Windshield (Solar) (Rain Sensor) ..... **38.5x60.0**  
**FW02220<sup>a</sup>** Windshield (Solar) ..... **38.5x60.0**  
**FD21162-63** Door F/R-L (Solar) (Laminated) ..... **20.0x32.0**  
**FD21160-61** Door F/R-L (Solar) ..... **20.0x32.0**  
**FD21319-20** Door R/R-L (Solar) (Laminated) ..... **21.0x27.0**  
**FD21245-46** Door R/R-L (Solar) ..... **21.0x27.0**  
**FV21247-48** Vent R/R-L (Solar) ..... **11.0x11.0**  
**FB21249<sup>a</sup>** Back Window (Heated)(Solar) ..... **35.0x47.3**  
<sup>a</sup> High Modulus Urethane,Dam,Primer - 2 Tubes

**S80 4 Door Sedan ..... 2007-2011**

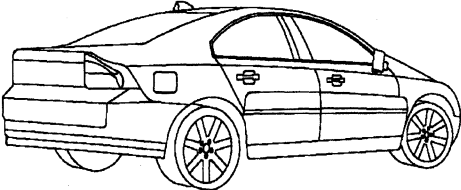

**FW03172<sup>d</sup>** Windshield (Solar) (PAAS System, W/Third Visor Frit, W/Night Vision, Rain Sensor) (07-08) ..... **35.4x60.2**  
**FW03157<sup>d</sup>** Windshield (Solar) (PAAS System, W/Third Visor Frit, Acoustic Interlayer, W/Lane Departure Warning System, Solar Coated, Rain Sensor) (09-11) ..... **35.4x60.2**  
**FW03156<sup>d</sup>** Windshield (Solar) (PAAS System, W/Third Visor Frit, W/Lane Departure Warning System, Rain Sensor) (09-11) ..... **35.4x60.2**  
**FW03155<sup>c,d</sup>** Windshield (Solar) (PAAS System, W/Third Visor Frit, Acoustic Interlayer, Rain Sensor) (09-11) ..... **35.4x60.2**  
**FW03154<sup>a,d</sup>** Windshield (Solar) (PAAS System, W/Third Visor Frit, Acoustic Interlayer) (09-11) ..... **35.4x60.2**  
**FW02873<sup>d</sup>** Windshield (Solar) (PAAS System, W/Third Visor Frit, Solar Coated, Rain Sensor) (07-08) ..... **35.4x60.2**  
**FW02736<sup>d</sup>** Windshield (Solar) (PAAS System, W/Third Visor Frit, Rain Sensor) (07-08) ..... **35.4x60.2**  
**FW02735<sup>b,d</sup>** Windshield (Solar) (PAAS System, W/Third Visor Frit) ..... **35.4x60.2**  
**FD23399-00** Door F/R-L (Solar) (Laminated, Hydrophobic Coating) ..... **22.0x32.8**  
**FD23397-98** Door F/R-L (Solar) (Hydrophobic Coating) ..... **22.0x32.8**  
**FD23395-96** Door F/R-L (Solar) ..... **22.0x32.8**  
**FD23403-04** Door R/R-L (Solar) (Laminated) ..... **20.3x24.2**  
**FD23401-02** Door R/R-L (Solar) ..... **20.3x24.2**  
**FV23407-08** Vent R/R-L (Encap)(Solar) (Laminated) ..... **13.2x13.5**  
**FV23405-06** Vent R/R-L (Encap)(Solar) ..... **13.2x13.5**  
**FB23409<sup>d</sup>** Back Window (Ant)(Heated)(Solar) ..... **37.0x49.0**  
<sup>a</sup> On Production Vehicles 2009 & Up  
<sup>b</sup> Not On Production Vehicles 2009 & Up  
<sup>c</sup> Rain Sensor Kit  
<sup>d</sup> High Modulus Urethane,Dam,Primer - 2 Tubes

**S80 4 Door Sedan ..... 2006**

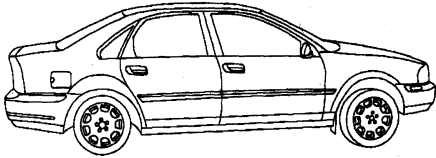

**FW02417<sup>a</sup>** Windshield (Solar) (Solar Coated, Rain Sensor) ..... **38.8x61.2**  
**FW02416<sup>a</sup>** Windshield (Solar) (Solar Coated) ..... **38.8x61.2**  
**FW02415<sup>a</sup>** Windshield (Rain Sensor) ..... **38.8x61.2**  
**FW02113<sup>a</sup>** Windshield ..... **38.8x61.2**  
**FD20631-32** Door F/R-L (Solar) (Laminated) ..... **20.5x34.7**  
**FD20629-30** Door F/R-L (Solar) ..... **20.5x34.7**  
**FD20635-36** Door R/R-L (Solar) (Laminated) ..... **20.5x29.0**  
**FD20633-34** Door R/R-L (Solar) ..... **20.5x29.0**  
**FQ20637-38<sup>b</sup>** Quarter R-L (Encap)(Solar) ..... **8.0x13.0**  
**FB20639<sup>a</sup>** Back Window (Heated)(Solar) ..... **31.5x53.0**  
<sup>a</sup> High Modulus Urethane,Dam,Primer - 2 Tubes  
<sup>b</sup> High Modulus Urethane,Dam,Primer - 1 Tube

**V50 4 Door Station Wagon ..... 2006-2011**

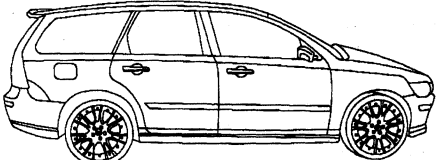

**FW02988<sup>b</sup>** Windshield (Solar) (Rain Sensor) (08-11) ..... **37.0x59.0**  
**FW02524<sup>b</sup>** Windshield (Solar) (Rain Sensor) (06-07) ..... **37.0x59.0**  
**FW02523<sup>b</sup>** Windshield (Solar) ..... **37.0x59.0**  
**FD22525-26** Door F/R-L (Solar) (Laminated) ..... **20.3x38.3**  
**FD22523-24** Door F/R-L (Solar) ..... **20.3x38.3**  
**FD22536-37** Door R/R-L (Solar) (Laminated) ..... **18.0x27.0**  
**FD22534-35** Door R/R-L (Solar) ..... **18.0x27.0**  
**FQ22539<sup>c</sup>** Quarter L (Encap)(Solar) ..... **16.0x35.0**  
**FQ22538<sup>c</sup>** Quarter R (Ant)(Encap)(Solar) ..... **16.0x35.0**  
**FB22540<sup>a</sup>** Back Window (Ant)(Heated)(1 Holes)(Solar) (W/Wiper) ..... **19.0x44.0**  
<sup>a</sup> High Modulus Urethane,Dam,Primer - 1.5 Tubes  
<sup>b</sup> High Modulus Urethane,Dam,Primer - 2 Tubes  
<sup>c</sup> High Modulus Urethane,Dam,Primer - 1 Tube

**V70 4 Door Station Wagon ..... 2008-2011**  
**XC70 4 Door Station Wagon ..... 2008-2011**

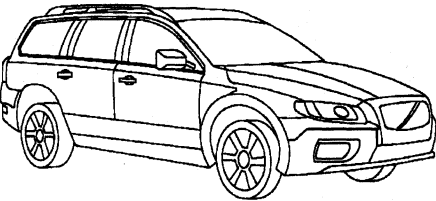

**FW03172<sup>e</sup>** Windshield (Solar) (PAAS System, W/Third Visor Frit, W/Night Vision, Rain Sensor) (08) ..... **35.4x60.2**  
**FW03157<sup>e</sup>** Windshield (Solar) (PAAS System, W/Third Visor Frit, Acoustic Interlayer, W/Lane Departure Warning System, Solar Coated, Rain Sensor) (09-11) ..... **35.4x60.2**  
**FW03156<sup>e</sup>** Windshield (Solar) (PAAS System, W/Third Visor Frit, W/Lane Departure Warning System, Rain Sensor) (09-11) ..... **35.4x60.2**

| V70                     | (cont.)  |
|-------------------------|--|
| FW03155 <sup>c</sup>    | Windshield (Solar) (PAAS System, W/Third Visor Frit, Acoustic Interlayer, Rain Sensor) (09-11) ..... 35.4x60.2 |
| FW03154 <sup>a</sup>    | Windshield (Solar) (PAAS System, W/Third Visor Frit, Acoustic Interlayer) (09-11) ..... 35.4x60.2              |
| FW02873 <sup>c</sup>    | Windshield (Solar) (PAAS System, W/Third Visor Frit, Solar Coated, Rain Sensor) (08) ..... 35.4x60.2           |
| FW02736 <sup>c</sup>    | Windshield (Solar) (PAAS System, W/Third Visor Frit, Rain Sensor) (08) ..... 35.4x60.2                         |
| FW02735 <sup>b</sup>    | Windshield (Solar) (PAAS System, W/Third Visor Frit) ..... 35.4x60.2   |
| FD23399-00              | Door F/R-L (Solar) (Laminated, Hydrophobic Coating) ..... 22.0x32.8  |
| FD23397-98              | Door F/R-L (Solar) (Hydrophobic Coating) ..... 22.0x32.8   |
| FD23395-96              | Door F/R-L (Solar) ..... 22.0x32.8   |
| FD23716-17              | Door R/R-L (Solar) (Laminated) ..... 19.0x27.0   |
| FD23714-15              | Door R/R-L (Solar) ..... 19.0x27.0   |
| FQ23720-21 <sup>f</sup> | Quarter R-L (Encap)(Solar) (Laminated) ..... 14.5x31.0   |
| FQ23718-19 <sup>f</sup> | Quarter R-L (Encap)(Solar) ..... 14.5x31.0   |
| FB23723 <sup>d</sup>    | Back Window (Heated)(Solar) (Laminated) ..... 18.5x47.0  |
| FB23722 <sup>d</sup>    | Back Window (Heated)(Solar) ..... 18.5x47.0  |

<sup>a</sup> On Production Vehicles 2009 & Up  
<sup>b</sup> Not On Production Vehicles 2009 & Up  
<sup>c</sup> Rain Sensor Kit  
<sup>d</sup> High Modulus Urethane,Dam,Primer - 1.5 Tubes  
<sup>e</sup> High Modulus Urethane,Dam,Primer - 2 Tubes  
<sup>f</sup> High Modulus Urethane,Dam,Primer - 1 Tube

**V70 4 Door Station Wagon..... 2006-2007**

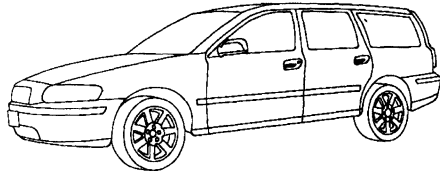

|                         |   |
|-------------------------|---|
| FW02322 <sup>b</sup>    | Windshield (Solar) (Rain Sensor) ..... 38.5x60.0          |
| FW02220 <sup>b</sup>    | Windshield (Solar) ..... 38.5x60.0                        |
| FD21162-63              | Door F/R-L (Solar) (Laminated) ..... 20.0x32.0            |
| FD21160-61              | Door F/R-L (Solar) ..... 20.0x32.0                        |
| FD21166-67              | Door R/R-L (Solar) (Laminated) ..... 20.0x28.0            |
| FD21164-65              | Door R/R-L (Solar) ..... 20.0x28.0                        |
| FQ21813 <sup>c</sup>    | Quarter L (Encap)(Solar) (W/Alarm) ..... 15.5x35.5        |
| FQ21169 <sup>c</sup>    | Quarter L (Ant)(Encap)(Solar) ..... 15.5x35.5             |
| FQ21321 <sup>c</sup>    | Quarter R (Ant)(Encap)(Solar) ..... 15.5x35.5             |
| FQ21170-71 <sup>c</sup> | Quarter R-L (Ant)(Encap)(Solar) (W/Alarm) ..... 15.5x35.5 |
| FQ21168 <sup>c</sup>    | Quarter R (Encap)(Solar) ..... 15.5x35.5                  |
| FB21172 <sup>a</sup>    | Back Window (Heated)(1 Holes)(Solar) ..... 18.0x55.0      |

<sup>a</sup> High Modulus Urethane,Dam,Primer - 1.5 Tubes  
<sup>b</sup> High Modulus Urethane,Dam,Primer - 2 Tubes  
<sup>c</sup> High Modulus Urethane,Dam,Primer - 1 Tube

**XC60 4 Door Utility..... 2010-2011**

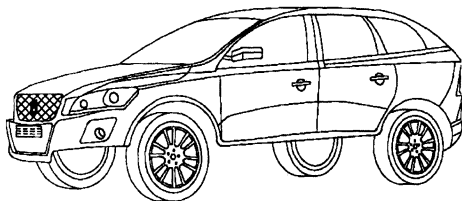

|                      |  |
|----------------------|--|
| FW03095 <sup>b</sup> | Windshield (Solar) (PAAS System, Infrared Interlayer, Rain Sensor) ..... 40.0x60.0             |
| FW03094 <sup>b</sup> | Windshield (Solar) (PAAS System, W/Lane Departure Warning System, Rain Sensor) ..... 40.0x60.0 |

| XC60                    | (cont.)   |
|-------------------------|---|
| FW03093 <sup>b</sup>    | Windshield (Solar) (PAAS System, Rain Sensor) ..... 40.0x60.0           |
| FW03092 <sup>b</sup>    | Windshield (Solar) (PAAS System) ..... 40.0x60.0                        |
| FD24724-25              | Door F/R-L (2 Holes)(Solar) (Aftermarket) (10) ..... 20.0x36.0          |
| FD24258-59              | Door F/R-L (Solar) (Laminated, Hydrophobic Coating) ..... 22.3x37.0     |
| FD24256-57              | Door F/R-L (2 Holes)(Solar) (Hydrophobic Coating) .. 22.3x37.0          |
| FD24262-63              | Door R/R-L (Solar) (Laminated) ..... 20.0x28.0                          |
| FD24260-61              | Door R/R-L (1 Holes)(Solar) ..... 20.0x28.0                             |
| FQ24270-71 <sup>c</sup> | Quarter R-L (Encap)(Solar) (Laminated, Chrome Moulding) ..... 14.5x24.0 |
| FQ24268-69 <sup>c</sup> | Quarter R-L (Encap)(Solar) (Laminated, Black Moulding) ..... 14.5x24.0  |
| FQ24266-67 <sup>c</sup> | Quarter R-L (Encap)(Solar) (Chrome Moulding) ..... 14.5x24.0            |
| FQ24264-65 <sup>c</sup> | Quarter R-L (Encap)(Solar) (Black Moulding) ..... 14.5x24.0             |
| FB24273 <sup>a</sup>    | Back Window (Heated)(Solar) (Laminated) ..... 22.0x47.0                 |
| FB24272 <sup>a</sup>    | Back Window (Heated)(Solar) ..... 22.0x47.0                             |

<sup>a</sup> High Modulus Urethane,Dam,Primer - 1.5 Tubes  
<sup>b</sup> High Modulus Urethane,Dam,Primer - 2 Tubes  
<sup>c</sup> High Modulus Urethane,Dam,Primer - 1 Tube

**XC70 4 Door Station Wagon..... 2006-2007**

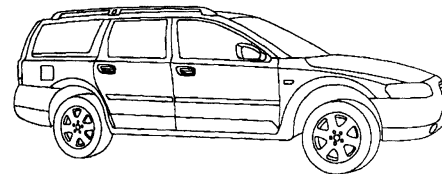

|                         |   |
|-------------------------|---|
| FW02322 <sup>b</sup>    | Windshield (Solar) (Rain Sensor) ..... 38.5x60.0                        |
| FW02220 <sup>b</sup>    | Windshield (Solar) ..... 38.5x60.0                                      |
| FD21162-63              | Door F/R-L (Solar) (Laminated) ..... 20.0x32.0                          |
| FD21160-61              | Door F/R-L (Solar) ..... 20.0x32.0                                      |
| FD21166-67              | Door R/R-L (Solar) (Laminated) ..... 20.0x28.0                          |
| FD21164-65              | Door R/R-L (Solar) ..... 20.0x28.0                                      |
| FQ21818-19 <sup>c</sup> | Quarter R-L (Ant)(Encap)(Solar) (W/Navigation, W/Alarm) ..... 16.3x33.5 |
| FQ21816-17 <sup>c</sup> | Quarter R-L (Ant)(Encap)(Solar) ..... 16.3x33.5                         |
| FQ21814-15 <sup>c</sup> | Quarter R-L (Encap)(Solar) (W/Alarm) ..... 16.3x33.5                    |
| FB21172 <sup>a</sup>    | Back Window (Heated)(1 Holes)(Solar) ..... 18.0x55.0                    |

<sup>a</sup> High Modulus Urethane,Dam,Primer - 1.5 Tubes  
<sup>b</sup> High Modulus Urethane,Dam,Primer - 2 Tubes  
<sup>c</sup> High Modulus Urethane,Dam,Primer - 1 Tube

**XC90 4 Door Utility..... 2006-2011**

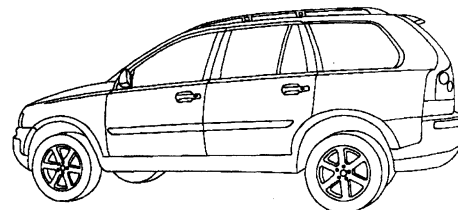

|                         |   |
|-------------------------|---|
| FW02405 <sup>b</sup>    | Windshield (Encap)(Solar) (Solar Coated, Rain Sensor) ..... 42.0x58.0 |
| FW02404 <sup>b</sup>    | Windshield (Encap)(Solar) (Rain Sensor) ..... 42.0x58.0               |
| FW02403 <sup>b</sup>    | Windshield (Encap)(Solar) (Solar Coated) ..... 42.0x58.0              |
| FW02310 <sup>b</sup>    | Windshield (Encap)(Solar) ..... 42.0x58.0                             |
| FD22024-25              | Door F/R-L (Solar) (Laminated, Solar Coated) ..... 22.0x33.0          |
| FD22022-23              | Door F/R-L (Solar) (Laminated) ..... 22.0x33.0                        |
| FD21687-88              | Door F/R-L (Solar) ..... 22.0x33.0                                    |
| FD22026-27              | Door R/R-L (Solar) (Laminated) ..... 22.0x25.0                        |
| FD21689-90              | Door R/R-L (Solar) ..... 22.0x25.0                                    |
| FQ21693-94 <sup>c</sup> | Quarter R-L (Encap)(Solar) ..... 18.5x30.5                            |

**XC90***(cont.)*

|  |                  |
|--|------------------|
| <b>FV22028-29</b> Vent R/R-L (Solar) (Laminated) .....       | <b>9.0x18.5</b>  |
| <b>FV21691-92</b> Vent R/R-L (Solar) .....                   | <b>9.0x18.5</b>  |
| <b>FB21695<sup>a</sup></b> Back Window (Heated)(Solar) ..... | <b>20.3x49.2</b> |

<sup>a</sup> High Modulus Urethane,Dam,Primer - 1.5 Tubes<sup>b</sup> High Modulus Urethane,Dam,Primer - 2 Tubes<sup>c</sup> High Modulus Urethane,Dam,Primer - 1 Tube

**Autocar**

|  |                  |
|--|------------------|
| <b>ACX Cab Over Engine</b> .....           | <b>2009-2011</b> |
| <b>WX - Xpeditor Cab Over Engine</b> ..... | <b>2006-2008</b> |

|   |                  |
|---|------------------|
| <b>DW00865-66<sup>a b</sup></b> Windshield R-L (06-11) .....          | <b>30.0x44.0</b> |
| <b>DT02780</b> Door F/R/Lower (Inner, Plexi Glass) (06-11) .....      | <b>9.0x27.0</b>  |
| <b>DT02715</b> Door F/R-L (06-11) .....                               | <b>24.0x25.0</b> |
| <b>DT02756</b> Roof F/R/Lower (Plexi Glass, Outer, Door) (06-11) .... | <b>9.0x15.0</b>  |
| <b>DT02714</b> Vent F/R-L (06-11) .....                               | <b>6.0x22.0</b>  |
| <b>DT01137</b> Back Window (06-11) .....                              | <b>16.0x58.0</b> |

<sup>a</sup> Urethane,Dam,Primer - 1.5 Tubes  
<sup>b</sup> Fast-Cure Urethane/Dam/Primer - Quantity 1.5

|  |                  |
|--|------------------|
| <b>WXLL - Xpeditor Cab Over Engine</b> ..... | <b>2006-2009</b> |
|--|------------------|

|  |                  |
|--|------------------|
| <b>DW00863-64<sup>a b</sup></b> Windshield R-L .....           | <b>30.0x49.0</b> |
| <b>DT02780</b> Door F/R/Lower (Inner, Plexi Glass) .....       | <b>9.0x27.0</b>  |
| <b>DT02715</b> Door F/R-L .....                                | <b>24.0x25.0</b> |
| <b>DT02756</b> Roof F/R/Lower (Plexi Glass, Outer, Door) ..... | <b>9.0x15.0</b>  |
| <b>DT02714</b> Vent F/R-L .....                                | <b>6.0x22.0</b>  |
| <b>DT01137</b> Back Window .....                               | <b>16.0x58.0</b> |

<sup>a</sup> Urethane,Dam,Primer - 1.5 Tubes  
<sup>b</sup> Fast-Cure Urethane/Dam/Primer - Quantity 1.5

**Chevrolet**

|                                     |             |
|-------------------------------------|-------------|
| <b>King Aluminum Step Van</b> ..... | <b>2006</b> |
|-------------------------------------|-------------|

|  |                  |
|--|------------------|
| <b>DL04757</b> Windshield R-L (91" Body Width) .....                   | <b>29.1x45.0</b> |
| <b>DL04756</b> Windshield R-L (87" Body Width) .....                   | <b>29.1x43.2</b> |
| <b>DL04755</b> Windshield R-L (78" Body Width) .....                   | <b>29.1x38.7</b> |
| <b>DT02594</b> Door F/R (Optional) .....                               | <b>28.0x30.0</b> |
| <b>DT02682</b> Door F/R-L (Stationary, Optional) .....                 | <b>14.0x26.0</b> |
| <b>DT02681</b> Door F/R-L (Movable, Optional) .....                    | <b>14.0x25.0</b> |
| <b>DT04758</b> Quarter F/R-L .....                                     | <b>16.2x27.5</b> |
| <b>DT02812</b> Back Window (Two, Optional) .....                       | <b>11.3x21.0</b> |
| <b>DT02675</b> Back Window (Overhead Door, Two, Magna, Optional) ..... | <b>8.0x19.0</b>  |

|   |                  |
|---|------------------|
| <b>Kodiak C5500 2 Door Conventional Cab</b> ..... | <b>2006-2009</b> |
| <b>Kodiak C7500 2 Door Conventional Cab</b> ..... | <b>2006-2009</b> |
| <b>Kodiak C4500 2 Door Conventional Cab</b> ..... | <b>2006-2009</b> |
| <b>Kodiak C8500 2 Door Conventional Cab</b> ..... | <b>2006-2009</b> |
| <b>Kodiak C6500 2 Door Conventional Cab</b> ..... | <b>2006-2009</b> |

|  |                  |
|--|------------------|
| <b>DW01520<sup>a c d</sup></b> Windshield (Solar) (Mirror Button) .....  | <b>39.0x73.0</b> |
| <b>DW01519<sup>a c d</sup></b> Windshield (Solar) .....  | <b>39.0x73.0</b> |
| <b>DD10375-76</b> Door F/R-L (Solar) .....   | <b>25.0x32.0</b> |
| <b>DY90106<sup>b</sup></b> Back Window (Encap)(Slider)(Solar) (Black Frame, Aftermarket, Power, 3 Panel Encapsulated) .....  | <b>22.0x57.0</b> |
| <b>DY90105<sup>b</sup></b> Back Window (Encap)(Slider)(Solar) (Black Frame, Aftermarket, Manual, 3 Panel Encapsulated) ..... | <b>22.0x57.0</b> |
| <b>DB10582</b> Back Window (Slider)(Solar) (OE, Manual) .....  | <b>22.0x57.0</b> |
| <b>DB10377<sup>b</sup></b> Back Window (Solar) (Stationary) .....  | <b>22.0x57.0</b> |

<sup>a</sup> May Require Two Person Installation  
<sup>b</sup> Urethane,Dam,Primer - 1.5 Tubes  
<sup>c</sup> Urethane,Dam,Primer - 2.5 Tubes  
<sup>d</sup> Fast-Cure Urethane/Dam/Primer - Quantity 2.5

|   |                  |
|---|------------------|
| <b>Kodiak C7500 4 Door Conventional Cab</b> ..... | <b>2006-2009</b> |
| <b>Kodiak C4500 4 Door Conventional Cab</b> ..... | <b>2006-2009</b> |
| <b>Kodiak C8500 4 Door Conventional Cab</b> ..... | <b>2006-2009</b> |
| <b>Kodiak C5500 4 Door Conventional Cab</b> ..... | <b>2006-2009</b> |
| <b>Kodiak C6500 4 Door Conventional Cab</b> ..... | <b>2006-2009</b> |

|  |                  |
|--|------------------|
| <b>DW01520<sup>a c d</sup></b> Windshield (Solar) (Mirror Button) .....  | <b>39.0x73.0</b> |
| <b>DW01519<sup>a c d</sup></b> Windshield (Solar) .....  | <b>39.0x73.0</b> |
| <b>DD10375-76</b> Door F/R-L (Solar) .....   | <b>25.0x32.0</b> |
| <b>DD10580</b> Door R/R-L (Solar) .....  | <b>22.0x24.0</b> |
| <b>DY90106<sup>b</sup></b> Back Window (Encap)(Slider)(Solar) (Black Frame, Aftermarket, Power, 3 Panel Encapsulated) .....  | <b>22.0x57.0</b> |
| <b>DY90105<sup>b</sup></b> Back Window (Encap)(Slider)(Solar) (Black Frame, Aftermarket, Manual, 3 Panel Encapsulated) ..... | <b>22.0x57.0</b> |
| <b>DB10582</b> Back Window (Slider)(Solar) (OE, Manual) .....  | <b>22.0x57.0</b> |
| <b>DB10581</b> Back Window (Heated)(Solar) (Stationary) .....  | <b>22.0x57.0</b> |
| <b>DB10377<sup>b</sup></b> Back Window (Solar) (Stationary) .....  | <b>22.0x57.0</b> |

<sup>a</sup> May Require Two Person Installation  
<sup>b</sup> Urethane,Dam,Primer - 1.5 Tubes  
<sup>c</sup> Urethane,Dam,Primer - 2.5 Tubes  
<sup>d</sup> Fast-Cure Urethane/Dam/Primer - Quantity 2.5

|                                     |                  |
|-------------------------------------|------------------|
| <b>T-Series T6500 Cabover</b> ..... | <b>2006-2009</b> |
| <b>T-Series T8500 Cabover</b> ..... | <b>2006-2009</b> |
| <b>T-Series T7500 Cabover</b> ..... | <b>2006-2009</b> |

|   |                  |
|---|------------------|
| <b>DW01301<sup>a c d</sup></b> Windshield .....       | <b>34.1x78.7</b> |
| <b>DD10603</b> Door F/R/Lower (Outer) .....           | <b>22.5x34.0</b> |
| <b>DD09213</b> Door F/R/Lower (7 Holes) (Inner) ..... | <b>15.0x25.0</b> |
| <b>DD09211-12</b> Door F/R-L .....                    | <b>27.0x32.5</b> |
| <b>DQ09214-15</b> Quarter R-L .....                   | <b>12.5x20.0</b> |
| <b>DB09216<sup>b</sup></b> Back Window .....          | <b>18.3x40.0</b> |

<sup>a</sup> May Require Two Person Installation  
<sup>b</sup> Urethane,Dam,Primer - 1.5 Tubes  
<sup>c</sup> Urethane,Dam,Primer - 2.5 Tubes  
<sup>d</sup> Fast-Cure Urethane/Dam/Primer - Quantity 2.5

|                                |             |
|--------------------------------|-------------|
| <b>UPS P700 Step Van</b> ..... | <b>2006</b> |
|--------------------------------|-------------|

|  |                  |
|--|------------------|
| <b>DL04756</b> Windshield R-L (87" Body Width) ..... | <b>29.1x43.2</b> |
|--|------------------|

|                            |                  |
|----------------------------|------------------|
| <b>W3500 Cabover</b> ..... | <b>2008-2010</b> |
| <b>W4500 Cabover</b> ..... | <b>2008-2010</b> |
| <b>W5500 Cabover</b> ..... | <b>2008-2010</b> |

|   |                  |
|---|------------------|
| <b>FW02924<sup>a b c</sup></b> Windshield .....         | <b>31.3x73.6</b> |
| <b>FD23949-50</b> Door F/R-L .....                      |                  |
| <sup>a</sup> May Require Two Person Installation        |                  |
| <sup>b</sup> Urethane,Dam,Primer - 2 Tubes              |                  |
| <sup>c</sup> Fast-Cure Urethane/Dam/Primer - Quantity 2 |                  |

|                            |                  |
|----------------------------|------------------|
| <b>W3500 Cabover</b> ..... | <b>2006-2007</b> |
| <b>W4500 Cabover</b> ..... | <b>2006-2007</b> |
| <b>W5500 Cabover</b> ..... | <b>2006-2007</b> |

|   |                  |
|---|------------------|
| <b>DW01231<sup>a b c</sup></b> Windshield .....         | <b>31.3x72.6</b> |
| <b>DD08941-42</b> Door F/R-L .....                      | <b>32.0x35.5</b> |
| <b>DB08943<sup>d</sup></b> Back Window .....            | <b>13.0x34.0</b> |
| <sup>a</sup> May Require Two Person Installation        |                  |
| <sup>b</sup> Urethane,Dam,Primer - 2 Tubes              |                  |
| <sup>c</sup> Fast-Cure Urethane/Dam/Primer - Quantity 2 |                  |
| <sup>d</sup> Urethane,Dam,Primer - 1 Tube               |                  |

|   |                  |
|---|------------------|
| <b>W4500</b> 4 Door Cabover .....                       | <b>2008-2010</b> |
| <b>W5500</b> 4 Door Cabover .....                       | <b>2008-2010</b> |
| <b>FW02924<sup>a b c</sup></b> Windshield .....         | <b>31.3x73.6</b> |
| <b>FD23949-50</b> Door F/R-L .....                      |                  |
| <b>FD23951-52</b> Door R/R-L .....                      |                  |
| <sup>a</sup> May Require Two Person Installation        |                  |
| <sup>b</sup> Urethane,Dam,Primer - 2 Tubes              |                  |
| <sup>c</sup> Fast-Cure Urethane/Dam/Primer - Quantity 2 |                  |

|   |                  |
|---|------------------|
| <b>W4500</b> 4 Door Cabover .....                       | <b>2006-2007</b> |
| <b>W5500</b> 4 Door Cabover .....                       | <b>2006-2007</b> |
| <b>DW01231<sup>a b c</sup></b> Windshield .....         | <b>31.3x72.6</b> |
| <b>DD08941-42</b> Door F/R-L .....                      | <b>32.0x35.5</b> |
| <b>DD10041-42</b> Door R/R-L .....                      | <b>23.0x29.5</b> |
| <b>DB11346<sup>d</sup></b> Back Window .....            |                  |
| <sup>a</sup> May Require Two Person Installation        |                  |
| <sup>b</sup> Urethane,Dam,Primer - 2 Tubes              |                  |
| <sup>c</sup> Fast-Cure Urethane/Dam/Primer - Quantity 2 |                  |
| <sup>d</sup> Urethane,Dam,Primer - 1.5 Tubes            |                  |

**Ford**

|   |                  |
|---|------------------|
| <b>LCF</b> Cab Forward .....                            | <b>2006-2010</b> |
| <b>DW01615<sup>a b c</sup></b> Windshield (Encap) ..... | <b>31.0x76.0</b> |
| <b>DD10909-10</b> Door F/R-L .....                      | <b>30.5x34.3</b> |
| <b>DB10911</b> Back Window (Gasket Set) .....           | <b>14.0x35.0</b> |
| <sup>a</sup> May Require Two Person Installation        |                  |
| <sup>b</sup> Urethane,Dam,Primer - 2 Tubes              |                  |
| <sup>c</sup> Fast-Cure Urethane/Dam/Primer - Quantity 2 |                  |

**Freightliner**

|  |                  |
|--|------------------|
| <b>Argosy</b> Cab Over Engine .....                                    | <b>2006-2009</b> |
| <b>DW01379-80<sup>b c</sup></b> Windshield R-L .....                   | <b>31.4x47.0</b> |
| <b>DW01387<sup>a d e</sup></b> Windshield (One-Piece) .....            | <b>32.7x95.7</b> |
| <b>DD09221</b> Door F/R/Lower .....                                    | <b>10.0x14.0</b> |
| <b>DD09219-20</b> Door F/R-L .....                                     | <b>22.1x25.0</b> |
| <b>DV09217-18</b> Vent F/R-L .....                                     | <b>9.5x22.0</b>  |
| <b>DB09285</b> Back Window (Laminated, Stationary) .....               | <b>20.8x36.3</b> |
| <b>DB09222</b> Back Window (Laminated, Stationary, Left & Right) ..... | <b>10.0x36.3</b> |
| <sup>a</sup> May Require Two Person Installation                       |                  |
| <sup>b</sup> Urethane,Dam,Primer - 1.5 Tubes                           |                  |
| <sup>c</sup> Fast-Cure Urethane/Dam/Primer - Quantity 1.5              |                  |
| <sup>d</sup> Urethane,Dam,Primer - 2.5 Tubes                           |                  |
| <sup>e</sup> Fast-Cure Urethane/Dam/Primer - Quantity 2.5              |                  |

|  |                  |
|--|------------------|
| <b>Business Class M2</b> 4 Door Conventional Cab ....                | <b>2006-2011</b> |
| <b>DW01625<sup>a</sup></b> Windshield (Gasket Set) .....             | <b>34.5x78.5</b> |
| <b>DW01494<sup>a b c</sup></b> Windshield (Encap) (Paint Band) ..... | <b>34.5x78.5</b> |
| <b>DD10237-38</b> Door F/R-L .....                                   | <b>22.5x28.0</b> |
| <b>DD10242-43</b> Door R/R-L .....                                   | <b>22.0x29.0</b> |
| <b>DV10235-36</b> Vent F/R-L (3 Holes) (Movable) .....               | <b>10.0x24.6</b> |
| <b>DV10233-34</b> Vent F/R-L (Stationary) .....                      | <b>11.0x26.5</b> |
| <b>DB10952</b> Back Window .....                                     | <b>14.8x61.7</b> |
| <sup>a</sup> May Require Two Person Installation                     |                  |
| <sup>b</sup> Urethane,Dam,Primer - 2.5 Tubes                         |                  |
| <sup>c</sup> Fast-Cure Urethane/Dam/Primer - Quantity 2.5            |                  |

|  |                  |
|--|------------------|
| <b>Business Class M2</b> Conventional Cab .....                      | <b>2006-2011</b> |
| <b>DW01625<sup>a</sup></b> Windshield (Gasket Set) .....             | <b>34.5x78.5</b> |
| <b>DW01494<sup>a b c</sup></b> Windshield (Encap) (Paint Band) ..... | <b>34.5x78.5</b> |
| <b>DD10237-38</b> Door F/R-L .....                                   | <b>22.5x28.0</b> |
| <b>DV10235-36</b> Vent F/R-L (3 Holes) (Movable) .....               | <b>10.0x24.6</b> |
| <b>DV10233-34</b> Vent F/R-L (Stationary) .....                      | <b>11.0x26.5</b> |
| <b>DB10952</b> Back Window .....                                     | <b>14.8x61.7</b> |
| <sup>a</sup> May Require Two Person Installation                     |                  |
| <sup>b</sup> Urethane,Dam,Primer - 2.5 Tubes                         |                  |
| <sup>c</sup> Fast-Cure Urethane/Dam/Primer - Quantity 2.5            |                  |

|  |                  |
|--|------------------|
| <b>Business Class M2</b> Extended Conventional Cab .                 | <b>2006-2011</b> |
| <b>DW01625<sup>a</sup></b> Windshield (Gasket Set) .....             | <b>34.5x78.5</b> |
| <b>DW01494<sup>a b c</sup></b> Windshield (Encap) (Paint Band) ..... | <b>34.5x78.5</b> |
| <b>DD10237-38</b> Door F/R-L .....                                   | <b>22.5x28.0</b> |
| <b>DQ10240-41</b> Quarter R-L (Movable) .....                        | <b>19.8x22.5</b> |
| <b>DV10235-36</b> Vent F/R-L (3 Holes) (Movable) .....               | <b>10.0x24.6</b> |
| <b>DV10233-34</b> Vent F/R-L (Stationary) .....                      | <b>11.0x26.5</b> |
| <b>DB10952</b> Back Window .....                                     | <b>14.8x61.7</b> |
| <sup>a</sup> May Require Two Person Installation                     |                  |
| <sup>b</sup> Urethane,Dam,Primer - 2.5 Tubes                         |                  |
| <sup>c</sup> Fast-Cure Urethane/Dam/Primer - Quantity 2.5            |                  |

|  |                  |
|--|------------------|
| <b>CL 112</b> Conventional Cab .....             | <b>2006-2009</b> |
| <b>Century Class C120</b> Conventional Cab ..... | <b>2006-2011</b> |
| <b>Columbia</b> Conventional Cab .....           | <b>2006-2011</b> |
| <b>Coronado</b> Conventional Cab .....           | <b>2006-2011</b> |

|  |                  |
|--|------------------|
| <b>DW01302-03<sup>a b c</sup></b> Windshield R-L (06-11) .....                 | <b>29.8x42.0</b> |
| <b>DW01306<sup>a d e</sup></b> Windshield (One-Piece) (06-11) .....            | <b>28.5x82.0</b> |
| <b>DD09221</b> Door F/R/Lower (06-11) .....                                    | <b>10.0x14.0</b> |
| <b>DD09219-20</b> Door F/R-L (06-11) .....                                     | <b>22.1x25.0</b> |
| <b>DV09217-18</b> Vent F/R-L (06-11) .....                                     | <b>9.5x22.0</b>  |
| <b>DB09285</b> Back Window (Laminated, Stationary) (06-11) .....               | <b>20.8x36.3</b> |
| <b>DB09222</b> Back Window (Laminated, Stationary, Left & Right) (06-11) ..... | <b>10.0x36.3</b> |
| <sup>a</sup> May Require Two Person Installation                               |                  |
| <sup>b</sup> Urethane,Dam,Primer - 1.5 Tubes                                   |                  |
| <sup>c</sup> Fast-Cure Urethane/Dam/Primer - Quantity 1.5                      |                  |
| <sup>d</sup> Urethane,Dam,Primer - 2.5 Tubes                                   |                  |
| <sup>e</sup> Fast-Cure Urethane/Dam/Primer - Quantity 2.5                      |                  |

|  |                  |
|--|------------------|
| <b>Cargo</b> Cabover.....  | <b>2006-2008</b> |
| <b>DW01439<sup>b c</sup></b> Windshield R-L (Right Or Left, Two-Piece) ..... | <b>37.2x45.4</b> |
| <b>DW00997<sup>a d e</sup></b> Windshield (One-Piece) .....                  | <b>32.8x75.8</b> |
| <b>DD07017-18</b> Door F/R-L (Movable) .....                                 | <b>23.0x26.0</b> |
| <b>DT02804</b> Door F/R-L .....  | <b>7.0x24.0</b>  |
| <b>DV07015-16</b> Vent F/R-L (Stationary) .....                              | <b>13.0x45.0</b> |
| <b>DT04733</b> Back Window R-L .....   | <b>19.0x33.0</b> |
| <sup>a</sup> May Require Two Person Installation                             |                  |
| <sup>b</sup> Urethane,Dam,Primer - 2 Tubes                                   |                  |
| <sup>c</sup> Fast-Cure Urethane/Dam/Primer - Quantity 2                      |                  |
| <sup>d</sup> Urethane,Dam,Primer - 2.5 Tubes                                 |                  |
| <sup>e</sup> Fast-Cure Urethane/Dam/Primer - Quantity 2.5                    |                  |

|   |                  |
|---|------------------|
| <b>Cascadia</b> Conventional Cab.....                             | <b>2008-2011</b> |
| <b>DW01731-32<sup>a b</sup></b> Windshield R-L (Gasket Set) ..... | <b>32.0x39.5</b> |
| <b>DW01729-30<sup>a b</sup></b> Windshield R-L (Encap) .....      | <b>34.0x41.5</b> |
| <b>DD11560-61</b> Door F/R-L .....                                |                  |
| <b>DV11617-18</b> Vent F/R-L .....                                |                  |
| <b>DB11562<sup>a</sup></b> Back Window R-L .....                  |                  |
| <sup>a</sup> Urethane,Dam,Primer - 1.5 Tubes                      |                  |
| <sup>b</sup> Fast-Cure Urethane/Dam/Primer - Quantity 1.5         |                  |

|  |                  |
|--|------------------|
| <b>Classic XL Conventional Cab</b> .....   | <b>2006-2010</b> |
| <b>FLD 120 SD Conventional Cab</b> .....   | <b>2006-2010</b> |
| <b>DL04746</b> Windshield R-L .....  | <b>19.8x34.6</b> |
| <b>DT02783</b> Door F/R/Lower .....  | <b>8.0x14.0</b>  |
| <b>DT04697</b> Door F/R-L .....  | <b>20.0x21.0</b> |
| <b>DT02782</b> Vent F/R-L (1 Holes) .....  | <b>8.0x18.0</b>  |
| <b>DY90047</b> Back Window (Encap)(Slider) (Aftermarket, 4 Piece Assembly) ..... | <b>21.0x37.0</b> |
| <b>DT04666</b> Back Window .....   | <b>21.0x37.0</b> |

|  |                  |
|--|------------------|
| <b>Condor Cabover/Cargo Truck</b> .....                                      | <b>2006-2008</b> |
| <b>DW01439<sup>a b</sup></b> Windshield R-L (Right Or Left, Two-Piece) ..... | <b>37.2x45.4</b> |
| <b>DT09936</b> Door F/R-L (Right Or Left) .....                              |                  |
| <b>DQ09937</b> Quarter R-L .....   |                  |
| <b>DB09938</b> Back Window .....   | <b>20.0x36.0</b> |
| <sup>a</sup> Urethane,Dam,Primer - 2 Tubes                                   |                  |
| <sup>b</sup> Fast-Cure Urethane/Dam/Primer - Quantity 2                      |                  |

|                                     |                  |
|-------------------------------------|------------------|
| <b>GMC</b>                          |                  |
| <b>T-Series T6500 Cabover</b> ..... | <b>2006-2009</b> |
| <b>T-Series T7500 Cabover</b> ..... | <b>2006-2009</b> |
| <b>T-Series T8500 Cabover</b> ..... | <b>2006-2009</b> |

|   |                  |
|---|------------------|
| <b>DW01301<sup>a c d</sup></b> Windshield .....           | <b>34.1x78.7</b> |
| <b>DD10603</b> Door F/R/Lower (Outer) .....               | <b>22.5x34.0</b> |
| <b>DD09213</b> Door F/R/Lower (7 Holes) (Inner) .....     | <b>15.0x25.0</b> |
| <b>DD09211-12</b> Door F/R-L .....                        | <b>27.0x32.5</b> |
| <b>DQ09214-15</b> Quarter R-L .....                       | <b>12.5x20.0</b> |
| <b>DB09216<sup>b</sup></b> Back Window .....              | <b>18.3x40.0</b> |
| <sup>a</sup> May Require Two Person Installation          |                  |
| <sup>b</sup> Urethane,Dam,Primer - 1.5 Tubes              |                  |
| <sup>c</sup> Urethane,Dam,Primer - 2.5 Tubes              |                  |
| <sup>d</sup> Fast-Cure Urethane/Dam/Primer - Quantity 2.5 |                  |

|  |                  |
|--|------------------|
| <b>Topkick C5500 2 Door Conventional Cab</b> ..... | <b>2006-2009</b> |
| <b>Topkick C4500 2 Door Conventional Cab</b> ..... | <b>2006-2009</b> |
| <b>Topkick C6500 2 Door Conventional Cab</b> ..... | <b>2006-2009</b> |
| <b>Topkick C7500 2 Door Conventional Cab</b> ..... | <b>2006-2009</b> |
| <b>Topkick C8500 2 Door Conventional Cab</b> ..... | <b>2006-2009</b> |

|  |                  |
|--|------------------|
| <b>DW01520<sup>a c d</sup></b> Windshield (Solar) (Mirror Button) .....  | <b>39.0x73.0</b> |
| <b>DW01519<sup>a c d</sup></b> Windshield (Solar) .....  | <b>39.0x73.0</b> |
| <b>DD10375-76</b> Door F/R-L (Solar) .....   | <b>25.0x32.0</b> |
| <b>DY90106<sup>b</sup></b> Back Window (Encap)(Slider)(Solar) (Black Frame, Aftermarket, Power, 3 Panel Encapsulated) .....  | <b>22.0x57.0</b> |
| <b>DY90105<sup>b</sup></b> Back Window (Encap)(Slider)(Solar) (Black Frame, Aftermarket, Manual, 3 Panel Encapsulated) ..... | <b>22.0x57.0</b> |
| <b>DB10582</b> Back Window (Slider)(Solar) (OE, Manual) .....  | <b>22.0x57.0</b> |
| <b>DB10377<sup>b</sup></b> Back Window (Solar) (Stationary) .....  | <b>22.0x57.0</b> |
| <sup>a</sup> May Require Two Person Installation   |                  |
| <sup>b</sup> Urethane,Dam,Primer - 1.5 Tubes   |                  |
| <sup>c</sup> Urethane,Dam,Primer - 2.5 Tubes   |                  |
| <sup>d</sup> Fast-Cure Urethane/Dam/Primer - Quantity 2.5  |                  |

|  |                  |
|--|------------------|
| <b>Topkick C6500 4 Door Conventional Cab</b> ..... | <b>2006-2009</b> |
| <b>Topkick C4500 4 Door Conventional Cab</b> ..... | <b>2006-2009</b> |
| <b>Topkick C8500 4 Door Conventional Cab</b> ..... | <b>2006-2009</b> |
| <b>Topkick C5500 4 Door Conventional Cab</b> ..... | <b>2006-2009</b> |
| <b>Topkick C7500 4 Door Conventional Cab</b> ..... | <b>2006-2009</b> |

|  |                  |
|--|------------------|
| <b>DW01520<sup>a c d</sup></b> Windshield (Solar) (Mirror Button) .....  | <b>39.0x73.0</b> |
| <b>DW01519<sup>a c d</sup></b> Windshield (Solar) .....  | <b>39.0x73.0</b> |
| <b>DD10375-76</b> Door F/R-L (Solar) .....   | <b>25.0x32.0</b> |
| <b>DD10580</b> Door R/R-L (Solar) .....  | <b>22.0x24.0</b> |
| <b>DY90106<sup>b</sup></b> Back Window (Encap)(Slider)(Solar) (Black Frame, Aftermarket, Power, 3 Panel Encapsulated) .....  | <b>22.0x57.0</b> |
| <b>DY90105<sup>b</sup></b> Back Window (Encap)(Slider)(Solar) (Black Frame, Aftermarket, Manual, 3 Panel Encapsulated) ..... | <b>22.0x57.0</b> |
| <b>DB10582</b> Back Window (Slider)(Solar) (OE, Manual) .....  | <b>22.0x57.0</b> |
| <b>DB10581</b> Back Window (Heated)(Solar) (Stationary) .....  | <b>22.0x57.0</b> |
| <b>DB10377<sup>b</sup></b> Back Window (Solar) (Stationary) .....  | <b>22.0x57.0</b> |
| <sup>a</sup> May Require Two Person Installation   |                  |
| <sup>b</sup> Urethane,Dam,Primer - 1.5 Tubes   |                  |
| <sup>c</sup> Urethane,Dam,Primer - 2.5 Tubes   |                  |
| <sup>d</sup> Fast-Cure Urethane/Dam/Primer - Quantity 2.5  |                  |

|                            |                  |
|----------------------------|------------------|
| <b>W3500 Cabover</b> ..... | <b>2008-2010</b> |
| <b>W4500 Cabover</b> ..... | <b>2008-2010</b> |
| <b>W5500 Cabover</b> ..... | <b>2008-2010</b> |

|   |                  |
|---|------------------|
| <b>FW02924<sup>a b c</sup></b> Windshield .....         | <b>31.3x73.6</b> |
| <b>FD23949-50</b> Door F/R-L .....                      |                  |
| <sup>a</sup> May Require Two Person Installation        |                  |
| <sup>b</sup> Urethane,Dam,Primer - 2 Tubes              |                  |
| <sup>c</sup> Fast-Cure Urethane/Dam/Primer - Quantity 2 |                  |

|                            |                  |
|----------------------------|------------------|
| <b>W3500 Cabover</b> ..... | <b>2006-2007</b> |
| <b>W4500 Cabover</b> ..... | <b>2006-2007</b> |
| <b>W5500 Cabover</b> ..... | <b>2006-2007</b> |

|   |                  |
|---|------------------|
| <b>DW01231<sup>a b c</sup></b> Windshield .....         | <b>31.3x72.6</b> |
| <b>DD08941-42</b> Door F/R-L .....                      | <b>32.0x35.5</b> |
| <b>DB08943<sup>d</sup></b> Back Window .....            | <b>13.0x34.0</b> |
| <sup>a</sup> May Require Two Person Installation        |                  |
| <sup>b</sup> Urethane,Dam,Primer - 2 Tubes              |                  |
| <sup>c</sup> Fast-Cure Urethane/Dam/Primer - Quantity 2 |                  |
| <sup>d</sup> Urethane,Dam,Primer - 1 Tube               |                  |

|                                   |                  |
|-----------------------------------|------------------|
| <b>W4500 4 Door Cabover</b> ..... | <b>2008-2010</b> |
| <b>W5500 4 Door Cabover</b> ..... | <b>2008-2010</b> |

|   |                  |
|---|------------------|
| <b>FW02924<sup>a b c</sup></b> Windshield .....         | <b>31.3x73.6</b> |
| <b>FD23949-50</b> Door F/R-L .....                      |                  |
| <b>FD23951-52</b> Door R/R-L .....                      |                  |
| <sup>a</sup> May Require Two Person Installation        |                  |
| <sup>b</sup> Urethane,Dam,Primer - 2 Tubes              |                  |
| <sup>c</sup> Fast-Cure Urethane/Dam/Primer - Quantity 2 |                  |

|                                   |                  |
|-----------------------------------|------------------|
| <b>W4500 4 Door Cabover</b> ..... | <b>2006-2007</b> |
| <b>W5500 4 Door Cabover</b> ..... | <b>2006-2007</b> |

|  |                  |
|--|------------------|
| <b>DW01231<sup>a b c</sup></b> Windshield .....  | <b>31.3x72.6</b> |
| <b>DD08941-42</b> Door F/R-L .....               | <b>32.0x35.5</b> |
| <b>DD10041-42</b> Door R/R-L .....               | <b>23.0x29.5</b> |
| <b>DB11346<sup>d</sup></b> Back Window .....     |                  |
| <sup>a</sup> May Require Two Person Installation |                  |
| <sup>b</sup> Urethane,Dam,Primer - 2 Tubes       |                  |



| <b>W4500</b>  | <i>(cont.)</i> | <b>ELF 300</b>  | <i>(cont.)</i> |
|---|----------------|---|----------------|
| <sup>c</sup> Fast-Cure Urethane/Dam/Primer - Quantity 2<br><sup>d</sup> Urethane,Dam,Primer - 1.5 Tubes   |                | <sup>d</sup> DB08943 <sup>d</sup> Back Window ..... 13.0x34.0<br><sup>a</sup> May Require Two Person Installation<br><sup>b</sup> Urethane,Dam,Primer - 2 Tubes<br><sup>c</sup> Fast-Cure Urethane/Dam/Primer - Quantity 2<br><sup>d</sup> Urethane,Dam,Primer - 1 Tube   |                |
| <b>145</b> Conventional Cab..... <b>2006-2010</b><br><b>165</b> Conventional Cab..... <b>2006-2010</b><br><b>185</b> Conventional Cab..... <b>2006-2010</b><br><b>238</b> Conventional Cab..... <b>2006-2011</b><br><b>258</b> Conventional Cab..... <b>2006-2011</b><br><b>268</b> Conventional Cab..... <b>2006-2011</b><br><b>338</b> Conventional Cab..... <b>2006-2011</b><br><b>358</b> Conventional Cab..... <b>2011</b>                                       |                | <b>ELF 400</b> Cabover (MEXICO Only)..... <b>2008-2010</b><br><b>ELF 500</b> Cabover (MEXICO Only)..... <b>2008-2010</b><br><b>ELF 600</b> Cabover (MEXICO Only)..... <b>2008-2010</b>  |                |
| <b>FW02521<sup>a c d</sup></b> Windshield (06-11) ..... <b>34.3x75.7</b><br><b>FD22513</b> Door F/L (06-11) ..... <b>29.0x35.5</b><br><b>FD22512</b> Door F/R (06-11) ..... <b>29.5x34.0</b><br><b>FB22514<sup>b</sup></b> Back Window (06-11) .....<br><sup>a</sup> May Require Two Person Installation<br><sup>b</sup> Urethane,Dam,Primer - 1.5 Tubes<br><sup>c</sup> Urethane,Dam,Primer - 2.5 Tubes<br><sup>d</sup> Fast-Cure Urethane/Dam/Primer - Quantity 2.5 |                | <b>FW02924<sup>a b c</sup></b> Windshield ..... <b>31.3x73.6</b><br><b>FD23949-50</b> Door F/R-L .....<br><sup>a</sup> May Require Two Person Installation<br><sup>b</sup> Urethane,Dam,Primer - 2 Tubes<br><sup>c</sup> Fast-Cure Urethane/Dam/Primer - Quantity 2   |                |
| <b>155</b> Cabover ..... <b>2010-2011</b><br>(CANADA Only)  |                | <b>FRR</b> Cabover ..... <b>2006-2008</b>   |                |
| <b>FW03281<sup>a b</sup></b> Windshield .....<br><sup>a</sup> Urethane,Dam,Primer - 2 Tubes<br><sup>b</sup> Fast-Cure Urethane/Dam/Primer - Quantity 2  |                | <b>DW01301<sup>a c d</sup></b> Windshield ..... <b>34.1x78.7</b><br><b>DD10603</b> Door F/R/Lower (Outer) ..... <b>22.5x34.0</b><br><b>DD09213</b> Door F/R/Lower (7 Holes) (Inner) ..... <b>15.0x25.0</b><br><b>DD09211-12</b> Door F/R-L ..... <b>27.0x32.5</b><br><b>DQ09214-15</b> Quarter R-L ..... <b>12.5x20.0</b><br><b>DB09216<sup>b</sup></b> Back Window ..... <b>18.3x40.0</b><br><sup>a</sup> May Require Two Person Installation<br><sup>b</sup> Urethane,Dam,Primer - 1.5 Tubes<br><sup>c</sup> Urethane,Dam,Primer - 2.5 Tubes<br><sup>d</sup> Fast-Cure Urethane/Dam/Primer - Quantity 2.5   |                |
| <b>198</b> Conventional Cab..... <b>2011</b><br>(CANADA Only)   |                | <b>FSR</b> Cabover ..... <b>2006</b><br><b>FTR</b> Cabover ..... <b>2006-2011</b><br><b>FVR</b> Cabover ..... <b>2006-2011</b><br><b>FXR</b> Cabover ..... <b>2006-2011</b>   |                |
| <b>FW02521<sup>a c d</sup></b> Windshield ..... <b>34.3x75.7</b><br><b>FD22513</b> Door F/L ..... <b>29.0x35.5</b><br><b>FD22512</b> Door F/R ..... <b>29.5x34.0</b><br><b>FB22514<sup>b</sup></b> Back Window .....<br><sup>a</sup> May Require Two Person Installation<br><sup>b</sup> Urethane,Dam,Primer - 1.5 Tubes<br><sup>c</sup> Urethane,Dam,Primer - 2.5 Tubes<br><sup>d</sup> Fast-Cure Urethane/Dam/Primer - Quantity 2.5                                 |                | <b>DW01301<sup>a c d</sup></b> Windshield (06-11) ..... <b>34.1x78.7</b><br><b>DD10603</b> Door F/R/Lower (Outer) (06-11) ..... <b>22.5x34.0</b><br><b>DD09213</b> Door F/R/Lower (7 Holes) (Inner) (06-11) ..... <b>15.0x25.0</b><br><b>DD09211-12</b> Door F/R-L (06-11) ..... <b>27.0x32.5</b><br><b>DQ09214-15</b> Quarter R-L (06-11) ..... <b>12.5x20.0</b><br><b>DB09216<sup>b</sup></b> Back Window (06-11) ..... <b>18.3x40.0</b><br><sup>a</sup> May Require Two Person Installation<br><sup>b</sup> Urethane,Dam,Primer - 1.5 Tubes<br><sup>c</sup> Urethane,Dam,Primer - 2.5 Tubes<br><sup>d</sup> Fast-Cure Urethane/Dam/Primer - Quantity 2.5   |                |
| <b>ELF 200</b> Cabover (MEXICO Only)..... <b>2008-2010</b><br><b>ELF 300</b> Cabover (MEXICO Only)..... <b>2008-2010</b>  |                | <b>HTR</b> 2 Door Conventional Cab ..... <b>2006-2009</b><br><b>HVR</b> 2 Door Conventional Cab ..... <b>2006-2009</b><br><b>HXR</b> 2 Door Conventional Cab ..... <b>2006-2009</b>   |                |
| <b>FW03119<sup>a b</sup></b> Windshield (Mexico Only) ..... <b>31.0x61.5</b><br><sup>a</sup> Urethane,Dam,Primer - 2 Tubes<br><sup>b</sup> Fast-Cure Urethane/Dam/Primer - Quantity 2   |                | <b>DW01520<sup>a c d</sup></b> Windshield (Solar) (Mirror Button) ..... <b>39.0x73.0</b><br><b>DW01519<sup>a c d</sup></b> Windshield (Solar) ..... <b>39.0x73.0</b><br><b>DD10375-76</b> Door F/R-L (Solar) ..... <b>25.0x32.0</b><br><b>DY90106<sup>b</sup></b> Back Window (Encap)(Slider)(Solar) (Black Frame, Aftermarket, Power, 3 Panel Encapsulated) ..... <b>22.0x57.0</b><br><b>DY90105<sup>b</sup></b> Back Window (Encap)(Slider)(Solar) (Black Frame, Aftermarket, Manual, 3 Panel Encapsulated) ..... <b>22.0x57.0</b><br><b>DB10582</b> Back Window (Slider)(Solar) (OE, Manual) ..... <b>22.0x57.0</b><br><b>DB10377<sup>b</sup></b> Back Window (Solar) (Stationary) ..... <b>22.0x57.0</b><br><sup>a</sup> May Require Two Person Installation<br><sup>b</sup> Urethane,Dam,Primer - 1.5 Tubes<br><sup>c</sup> Urethane,Dam,Primer - 2.5 Tubes<br><sup>d</sup> Fast-Cure Urethane/Dam/Primer - Quantity 2.5 |                |
| <b>ELF 300</b> Cabover (MEXICO Only)..... <b>2006-2007</b><br><b>ELF 400</b> Cabover (MEXICO Only)..... <b>2006-2007</b><br><b>ELF 450</b> Cabover (MEXICO Only)..... <b>2006-2007</b>  |                | <b>DW01231<sup>a b c</sup></b> Windshield ..... <b>31.3x72.6</b><br><b>DD08941-42</b> Door F/R-L ..... <b>32.0x35.5</b>   |                |

|  |                  |
|--|------------------|
| <b>HTR</b> 4 Door Conventional Cab.....  | <b>2006-2009</b> |
| <b>HVR</b> 4 Door Conventional Cab .....   | <b>2006-2009</b> |
| <b>DW01520<sup>a c d</sup></b> Windshield (Solar) (Mirror Button) .....  | <b>39.0x73.0</b> |
| <b>DW01519<sup>a c d</sup></b> Windshield (Solar) .....  | <b>39.0x73.0</b> |
| <b>DD10375-76</b> Door F/R-L (Solar) .....   | <b>25.0x32.0</b> |
| <b>DD10580</b> Door R/R-L (Solar) .....  | <b>22.0x24.0</b> |
| <b>DY90106<sup>b</sup></b> Back Window (Encap)(Slider)(Solar) (Black Frame, Aftermarket, Power, 3 Panel Encapsulated) .....  | <b>22.0x57.0</b> |
| <b>DY90105<sup>b</sup></b> Back Window (Encap)(Slider)(Solar) (Black Frame, Aftermarket, Manual, 3 Panel Encapsulated) ..... | <b>22.0x57.0</b> |
| <b>DB10582</b> Back Window (Slider)(Solar) (OE, Manual) .....  | <b>22.0x57.0</b> |
| <b>DB10581</b> Back Window (Heated)(Solar) (Stationary) .....  | <b>22.0x57.0</b> |
| <b>DB10377<sup>b</sup></b> Back Window (Solar) (Stationary) .....  | <b>22.0x57.0</b> |

<sup>a</sup> May Require Two Person Installation  
<sup>b</sup> Urethane,Dam,Primer - 1.5 Tubes  
<sup>c</sup> Urethane,Dam,Primer - 2.5 Tubes  
<sup>d</sup> Fast-Cure Urethane/Dam/Primer - Quantity 2.5

|   |                  |
|---|------------------|
| <b>NPR</b> 4 Door Cabover.....                  | <b>2008-2011</b> |
| <b>NPR HD</b> 4 Door Cabover.....               | <b>2008-2011</b> |
| <b>NQR</b> 4 Door Cabover.....                  | <b>2008-2011</b> |
| <b>FW02924<sup>a b c</sup></b> Windshield ..... | <b>31.3x73.6</b> |
| <b>FD23949-50</b> Door F/R-L .....              |                  |
| <b>FD23951-52</b> Door R/R-L .....              |                  |

<sup>a</sup> May Require Two Person Installation  
<sup>b</sup> Urethane,Dam,Primer - 2 Tubes  
<sup>c</sup> Fast-Cure Urethane/Dam/Primer - Quantity 2

|   |                  |
|---|------------------|
| <b>NPR</b> 4 Door Cabover.....                  | <b>2006-2007</b> |
| <b>NPR HD</b> 4 Door Cabover.....               | <b>2006-2007</b> |
| <b>NQR</b> 4 Door Cabover.....                  | <b>2006-2007</b> |
| <b>DW01231<sup>a b c</sup></b> Windshield ..... | <b>31.3x72.6</b> |
| <b>DD08941-42</b> Door F/R-L .....              | <b>32.0x35.5</b> |
| <b>DD10041-42</b> Door R/R-L .....              | <b>23.0x29.5</b> |
| <b>DB11346<sup>d</sup></b> Back Window .....    |                  |

<sup>a</sup> May Require Two Person Installation  
<sup>b</sup> Urethane,Dam,Primer - 2 Tubes  
<sup>c</sup> Fast-Cure Urethane/Dam/Primer - Quantity 2  
<sup>d</sup> Urethane,Dam,Primer - 1.5 Tubes

|   |                  |
|---|------------------|
| <b>NPR</b> Cabover.....                                 | <b>2008-2011</b> |
| <b>NPR DIESEL</b> Cabover.....                          | <b>2007</b>      |
| <b>NPR HD</b> Cabover.....                              | <b>2008-2011</b> |
| <b>NQR</b> Cabover.....                                 | <b>2008-2011</b> |
| <b>NRR</b> Cabover.....                                 | <b>2008-2011</b> |
| <b>FW02924<sup>a b c</sup></b> Windshield (07-11) ..... | <b>31.3x73.6</b> |
| <b>FD23949-50</b> Door F/R-L (07-11) .....              |                  |

<sup>a</sup> May Require Two Person Installation  
<sup>b</sup> Urethane,Dam,Primer - 2 Tubes  
<sup>c</sup> Fast-Cure Urethane/Dam/Primer - Quantity 2

|   |                  |
|---|------------------|
| <b>DW01231<sup>a b c</sup></b> Windshield (06-07) ..... | <b>31.3x72.6</b> |
| <b>DD08941-42</b> Door F/R-L (06-07) .....              | <b>32.0x35.5</b> |
| <b>DB08943<sup>d</sup></b> Back Window (06-07) .....    | <b>13.0x34.0</b> |

<sup>a</sup> May Require Two Person Installation  
<sup>b</sup> Urethane,Dam,Primer - 2 Tubes  
<sup>c</sup> Fast-Cure Urethane/Dam/Primer - Quantity 2  
<sup>d</sup> Urethane,Dam,Primer - 1 Tube

|                              |                  |
|------------------------------|------------------|
| <b>NPR GAS</b> Cabover ..... | <b>2007</b>      |
| <b>NPR</b> Cabover .....     | <b>2006</b>      |
| <b>NPR HD</b> Cabover.....   | <b>2006-2007</b> |
| <b>NQR</b> Cabover.....      | <b>2006-2007</b> |
| <b>NRR</b> Cabover.....      | <b>2006-2007</b> |

| <b>Kenworth</b>                    |                  |
|------------------------------------|------------------|
| <b>C500</b> Conventional Cab ..... | <b>2006-2011</b> |
| <b>T600</b> Conventional Cab.....  | <b>2006-2007</b> |
| <b>T660</b> Conventional Cab.....  | <b>2008-2011</b> |
| <b>T700</b> Conventional Cab.....  | <b>2011</b>      |
| <b>T800</b> Conventional Cab.....  | <b>2006-2011</b> |
| <b>W900</b> Conventional Cab.....  | <b>2006-2011</b> |

|  |                  |
|--|------------------|
| <b>DW01656-57<sup>d e</sup></b> Windshield R-L (Paint Band) (06-11) .....                | <b>23.5x32.0</b> |
| <b>DW01707</b> Windshield R-L (Right Or Left, Flat, New Style Dash) (06-11) .....        | <b>19.4x29.2</b> |
| <b>DL04653</b> Windshield (Sleeper Cab) (06-11) .....                                    | <b>15.0x37.0</b> |
| <b>DW01655<sup>a b c</sup></b> Windshield (Paint Band) (06-11) .....                     | <b>23.5x64.3</b> |
| <b>DT02691</b> Door F/R/Lower (06-11) .....  | <b>11.0x12.0</b> |
| <b>DT04774</b> Door F/R-L (Optional) (06-11) .....                                       | <b>30.0x32.0</b> |
| <b>DT04627</b> Door F/R-L (06-11) .....  | <b>22.0x23.0</b> |
| <b>DQ11289-90</b> Quarter R-L (Day Cab) (06-11) .....                                    |                  |
| <b>DT02814</b> Vent F/R-L (1 Holes) (06-11) .....  | <b>8.0x19.0</b>  |
| <b>DY90056</b> Back Window (Encap)(Slider) (Aftermarket, 4 Piece Assembly) (06-11) ..... | <b>12.0x28.0</b> |
| <b>DY90055</b> Back Window (Encap)(Slider) (Aftermarket, 4 Piece Assembly) (06-11) ..... | <b>17.0x28.0</b> |
| <b>DT04655</b> Back Window (06-11) .....   | <b>17.0x28.0</b> |
| <b>DT04654</b> Back Window (Movable) (06-11) .....                                       | <b>20.0x31.0</b> |
| <b>DT02567</b> Back Window (06-11) .....   | <b>12.0x28.0</b> |

<sup>a</sup> May Require Two Person Installation  
<sup>b</sup> Urethane,Dam,Primer - 2 Tubes  
<sup>c</sup> Fast-Cure Urethane/Dam/Primer - Quantity 2  
<sup>d</sup> Urethane,Dam,Primer - 1.5 Tubes  
<sup>e</sup> Fast-Cure Urethane/Dam/Primer - Quantity 1.5

|   |             |
|---|-------------|
| <b>Foden</b> Cab Over Engine (MEXICO Only).....             | <b>2006</b> |
| <b>DW01825<sup>a b</sup></b> Windshield (Mexico Only) ..... |             |
| <b>DD11769-70</b> Door F/R-L (Mexico Only) .....            |             |
| <b>DV11767-68</b> Vent F/R-L (Mexico Only) .....            |             |

<sup>a</sup> Urethane,Dam,Primer - 2 Tubes  
<sup>b</sup> Fast-Cure Urethane/Dam/Primer - Quantity 2

|   |                   |
|---|-------------------|
| <b>K260</b> Cabover .....                     | <b>2007-2011</b>  |
| <b>K360</b> Cabover .....                     | <b>2007-2011</b>  |
| <b>DW01799<sup>a b</sup></b> Windshield ..... | <b>27.3x100.4</b> |
| <b>DD11684-85</b> Door F/R-L .....            |                   |

<sup>a</sup> Urethane,Dam,Primer - 2.5 Tubes  
<sup>b</sup> Fast-Cure Urethane/Dam/Primer - Quantity 2.5

|  |                  |
|--|------------------|
| <b>KW45</b> Cabover (MEXICO Only).....   | <b>2006-2010</b> |
| <b>KW55</b> Cabover (MEXICO Only).....   | <b>2006-2010</b> |
| <b>DW01799<sup>a</sup></b> Windshield ..... 27.3x100.4<br><b>DD11684-85</b> Door F/R-L .....<br><sup>a</sup> Urethane,Dam,Primer - 2.5 Tubes<br><sup>b</sup> Fast-Cure Urethane/Dam/Primer - Quantity 2.5  |                  |
| <b>T170</b> Conventional Cab.....  | <b>2008-2011</b> |
| <b>T270</b> Conventional Cab.....  | <b>2008-2011</b> |
| <b>T300</b> Conventional Cab.....  | <b>2006-2008</b> |
| <b>T370</b> Conventional Cab.....  | <b>2008-2011</b> |
| <b>T440</b> Conventional Cab.....  | <b>2011</b>      |
| <b>T470</b> Conventional Cab.....  | <b>2009-2011</b> |
| <b>DW01656-57<sup>d</sup></b> Windshield R-L (Paint Band) (06-11) ..... 23.5x32.0<br><b>DW01655<sup>a</sup></b> Windshield (Paint Band) (06-11) ..... 23.5x64.3<br><b>DD09350</b> Door F/R/Lower (06-11) ..... 10.0x11.2<br><b>DT04774</b> Door F/R-L (Optional) (06-11) ..... 30.0x32.0<br><b>DT04627</b> Door F/R-L (06-11) ..... 22.0x23.0<br><b>DQ11289-90</b> Quarter R-L (Day Cab) (06-11) .....<br><b>DT02814</b> Vent F/R-L (1 Holes) (06-11) ..... 8.0x19.0<br><b>DY90056</b> Back Window (Encap)(Slider) (Aftermarket, 4 Piece Assembly) (06-11) ..... 12.0x28.0<br><b>DY90055</b> Back Window (Encap)(Slider) (Aftermarket, 4 Piece Assembly) (06-11) ..... 17.0x28.0<br><b>DB09351<sup>f</sup></b> Back Window (Stationary) (06-11) ..... 17.0x36.0<br><b>DT04654</b> Back Window (Movable) (06-11) ..... 20.0x31.0<br><sup>a</sup> May Require Two Person Installation<br><sup>b</sup> Urethane,Dam,Primer - 2 Tubes<br><sup>c</sup> Fast-Cure Urethane/Dam/Primer - Quantity 2<br><sup>d</sup> Urethane,Dam,Primer - 1.5 Tubes<br><sup>e</sup> Fast-Cure Urethane/Dam/Primer - Quantity 1.5<br><sup>f</sup> Urethane,Dam,Primer - 1 Tube |                  |
| <b>T2000</b> Conventional Cab .....  | <b>2006-2011</b> |
| <b>DW01311-12<sup>b</sup></b> Windshield R-L ..... 28.0x41.0<br><b>DW01310<sup>a</sup></b> Windshield ..... 28.0x84.0<br><b>DD09256-57</b> Door F/R-L ..... 19.0x26.0<br><b>DV09254-55</b> Vent F/R-L ..... 14.3x28.0<br><sup>a</sup> May Require Two Person Installation<br><sup>b</sup> Urethane,Dam,Primer - 1.5 Tubes<br><sup>c</sup> Fast-Cure Urethane/Dam/Primer - Quantity 1.5<br><sup>d</sup> Urethane,Dam,Primer - 2.5 Tubes<br><sup>e</sup> Fast-Cure Urethane/Dam/Primer - Quantity 2.5  |                  |
| <b>MCI</b>   |                  |
| <b>102"</b> Bus.....   | <b>2006-2008</b> |
| <b>DW01545<sup>a</sup></b> Windshield L (Paint Band, Two-Piece) ..... 48.0x51.0<br><b>DW01544<sup>a</sup></b> Windshield R (Paint Band, Two-Piece) ..... 48.0x51.0<br><sup>a</sup> May Require Two Person Installation   |                  |
| <b>Renaissance</b> Bus.....  | <b>2006-2008</b> |
| <b>DW01543<sup>a</sup></b> Windshield L (Paint Band, Two-Piece) ..... 47.8x62.4<br><b>DW01542<sup>a</sup></b> Windshield R (Paint Band, Two-Piece) ..... 47.8x62.4<br><b>DW01541<sup>a</sup></b> Windshield R-L (Right Or Left, Two-Piece) ..... 47.8x62.4<br><sup>a</sup> May Require Two Person Installation   |                  |

|   |                  |
|---|------------------|
| <b>Mack</b>   |                  |
| <b>CH600</b> Conventional Cab.....  | <b>2006-2007</b> |
| <b>CL600/CL700</b> Conventional Cab .....   | <b>2006-2007</b> |
| <b>CX Vision</b> Conventional Cab.....  | <b>2006-2007</b> |
| <b>DW01080-81<sup>a</sup></b> Windshield R-L ..... 24.8x40.6<br><b>DT04715</b> Door F/R-L ..... 19.0x23.0<br><b>DT02793</b> Door F/R-L/Lower (Lower) ..... 6.0x12.0<br><b>DT02792</b> Vent F/R-L ..... 10.0x20.0<br><b>DB10220</b> Back Window (Day Cab) ..... 19.5x48.0<br><sup>a</sup> Urethane,Dam,Primer - 1.5 Tubes<br><sup>b</sup> Fast-Cure Urethane/Dam/Primer - Quantity 1.5   |                  |
| <b>CT713 Granite Series</b> 2 Door Conventional Cab   | <b>2007-2009</b> |
| <b>CTP713 Granite Serie</b> 2 Door Conventional Cab   | <b>2007-2009</b> |
| <b>CV513 Granite Series</b> 2 Door Conventional Cab   | <b>2006-2009</b> |
| <b>CV533 Granite Series</b> 2 Door Conventional Cab   | <b>2009</b>      |
| <b>CV712 Granite Series</b> 2 Door Conventional Cab   | <b>2006-2008</b> |
| <b>CV713 Granite Series</b> 2 Door Conventional Cab   | <b>2006-2009</b> |
| <b>GU712 Granite Series</b> 2 Door Conventional Cab   | <b>2008-2009</b> |
| <b>GU713 Granite Series</b> 2 Door Conventional Cab   | <b>2008-2009</b> |
| <b>GU812 Granite Series</b> 2 Door Conventional Cab   | <b>2008-2009</b> |
| <b>GU813 Granite Series</b> 2 Door Conventional Cab   | <b>2008-2009</b> |
| <b>Granite Series</b> 2 Door Conventional Cab.....  | <b>2010-2011</b> |
| <b>DW01564-65</b> Windshield R-L (Heated) (Heated Wiper Park Area) (06-11) ..... 24.8x40.6<br><b>DW01080-81<sup>a</sup></b> Windshield R-L (06-11) ..... 24.8x40.6<br><b>DD10218-19</b> Door F/R-L (06-11) ..... 26.5x28.0<br><b>DB10220</b> Back Window (Day Cab) (06-11) ..... 19.5x48.0<br><sup>a</sup> Urethane,Dam,Primer - 1.5 Tubes<br><sup>b</sup> Fast-Cure Urethane/Dam/Primer - Quantity 1.5   |                  |
| <b>CX Pinnacle</b> Conventional Cab .....   | <b>2007-2011</b> |
| <b>CXU 613</b> Conventional Cab.....  | <b>2008-2011</b> |
| <b>DW01080-81<sup>d</sup></b> Windshield R-L (07-11) ..... 24.8x40.6<br><b>DW01842<sup>a</sup></b> Windshield (One-Piece, Optional) (07-11) .....<br><b>DT04715</b> Door F/R-L (07-11) ..... 19.0x23.0<br><b>DT02793</b> Door F/R-L/Lower (Lower) (07-11) ..... 6.0x12.0<br><b>DT02792</b> Vent F/R-L (07-11) ..... 10.0x20.0<br><b>DB10220</b> Back Window (Day Cab) (07-11) ..... 19.5x48.0<br><sup>a</sup> May Require Two Person Installation<br><sup>b</sup> Urethane,Dam,Primer - 2 Tubes<br><sup>c</sup> Fast-Cure Urethane/Dam/Primer - Quantity 2<br><sup>d</sup> Urethane,Dam,Primer - 1.5 Tubes<br><sup>e</sup> Fast-Cure Urethane/Dam/Primer - Quantity 1.5 |                  |
| <b>DM Series</b> Conventional Cab .....   | <b>2006</b>      |
| <b>DMM Series</b> Conventional Cab.....   | <b>2006</b>      |
| <b>RB Series</b> Conventional Cab .....   | <b>2006</b>      |
| <b>DW00662-63<sup>a</sup></b> Windshield R-L ..... 22.0x34.0<br><b>DT04408</b> Door F/R-L ..... 20.0x22.0<br><b>DT02462</b> Vent F/R-L ..... 8.0x20.0<br><b>DT04665</b> Back Window (2 Holes) (Two, Movable) ..... 16.0x21.0<br><b>DT01065</b> Back Window ..... 18.0x44.0<br><sup>a</sup> Urethane,Dam,Primer - 1.5 Tubes<br><sup>b</sup> Fast-Cure Urethane/Dam/Primer - Quantity 1.5   |                  |

|   |                  |
|---|------------------|
| <b>MR600 Cabover</b> .....  | <b>2006-2007</b> |
| DL02752 Windshield R-L .....  | 38.0x39.0        |
| DT02753 Door F/R/Lower .....  | 10.0x17.0        |
| DT04664 Door F/R-L (Stationary, MR Series) .....                          | 17.0x28.0        |
| DT04663 Door F/R-L (MC Series) .....                                      | 22.0x25.0        |
| DT02754 Door F/R-L (Movable, MR Series) .....                             | 14.0x28.0        |
| DQ09239 Quarter L .....   | 7.5x20.5         |
| DT02462 Vent F/R-L .....  | 8.0x20.0         |
| DY90057 Back Window (Encap)(Slider) (Aftermarket, 4 Piece Assembly) ..... | 18.0x44.0        |
| DT04665 Back Window (2 Holes) (Two, Movable) .....                        | 16.0x21.0        |
| DT01065 Back Window .....   | 18.0x44.0        |
| <b>MRU613 Cabover</b> .....   | <b>2008-2011</b> |
| <b>TerraPro Cabover</b> .....   | <b>2008-2011</b> |
| DW01315 <sup>a b</sup> Windshield R-L .....                               | 37.5x41.5        |
| DD09264 Door F/L (Movable) .....  | 18.3x22.5        |
| DD09263 Door F/R (Stationary) .....                                       | 20.1x28.7        |
| DB09265 <sup>a</sup> Back Window .....                                    | 17.5x43.0        |
| <sup>a</sup> Urethane,Dam,Primer - 1.5 Tubes                              |                  |
| <sup>b</sup> Fast-Cure Urethane/Dam/Primer - Quantity 1.5                 |                  |
| <b>Series LE Cabover</b> .....  | <b>2006-2007</b> |
| DW01315 <sup>a b</sup> Windshield R-L .....                               | 37.5x41.5        |
| DD09264 Door F/L (Movable) .....  | 18.3x22.5        |
| DD09263 Door F/R (Stationary) .....                                       | 20.1x28.7        |
| DB09265 <sup>a</sup> Back Window .....                                    | 17.5x43.0        |
| <sup>a</sup> Urethane,Dam,Primer - 1.5 Tubes                              |                  |
| <sup>b</sup> Fast-Cure Urethane/Dam/Primer - Quantity 1.5                 |                  |
| <b>Mitsubishi</b>   |                  |
| <b>Fuso FE 4 Door Cabover</b> .....                                       | <b>2006-2011</b> |
| FW02541 <sup>a b c</sup> Windshield .....                                 | 30.5x72.5        |
| FD24434-35 Door F/R-L .....   |                  |
| FD24436-37 Door R/R-L .....   |                  |
| FB24438 Back Window .....   |                  |
| <sup>a</sup> May Require Two Person Installation                          |                  |
| <sup>b</sup> Urethane,Dam,Primer - 2 Tubes                                |                  |
| <sup>c</sup> Fast-Cure Urethane/Dam/Primer - Quantity 2                   |                  |
| <b>Fuso FE Cabover</b> .....  | <b>2006-2011</b> |
| <b>Fuso FG Cabover</b> .....  | <b>2006-2011</b> |
| FW02541 <sup>a b c</sup> Windshield .....                                 | 30.5x72.5        |
| FD24434-35 Door F/R-L .....   |                  |
| FB24438 Back Window .....   |                  |
| <sup>a</sup> May Require Two Person Installation                          |                  |
| <sup>b</sup> Urethane,Dam,Primer - 2 Tubes                                |                  |
| <sup>c</sup> Fast-Cure Urethane/Dam/Primer - Quantity 2                   |                  |
| <b>Fuso FK Cabover</b> .....  | <b>2006-2011</b> |
| <b>Fuso FM Cabover</b> .....  | <b>2006-2011</b> |
| FW02014 <sup>a b c</sup> Windshield .....                                 | 33.7x75.5        |
| <sup>a</sup> May Require Two Person Installation                          |                  |
| <sup>b</sup> Urethane,Dam,Primer - 2.5 Tubes                              |                  |
| <sup>c</sup> Fast-Cure Urethane/Dam/Primer - Quantity 2.5                 |                  |

|   |                  |
|---|------------------|
| <b>Morgan Olson</b>   |                  |
| <b>Route Star Step Van</b> .....  | <b>2006-2011</b> |
| DW01688 <sup>a b</sup> Windshield R-L (93" Body Width) .....  | 30.4x43.4        |
| DW01687 <sup>a b</sup> Windshield R-L (86" Body Width) .....  | 30.4x40.0        |
| DW01686 <sup>a b</sup> Windshield R-L (82" Body Width) .....  | 30.4x38.0        |
| <sup>a</sup> Urethane,Dam,Primer - 1.5 Tubes  |                  |
| <sup>b</sup> Fast-Cure Urethane/Dam/Primer - Quantity 1.5   |                  |
| <b>UPS P1000 Step Van</b> .....   | <b>2006-2011</b> |
| <b>USPS One Ton Step Van</b> .....  | <b>2006-2011</b> |
| DW01689 <sup>a b</sup> Windshield R-L .....   | 30.9x40.6        |
| <sup>a</sup> Urethane,Dam,Primer - 1.5 Tubes  |                  |
| <sup>b</sup> Fast-Cure Urethane/Dam/Primer - Quantity 1.5   |                  |
| <b>NABI</b>   |                  |
| <b>60-BRT Bus</b> .....   | <b>2006-2011</b> |
| DW01792 <sup>a b</sup> Windshield (Solar) .....   | 52.0x91.0        |
| <sup>a</sup> Urethane,Dam,Primer - 3 Tubes  |                  |
| <sup>b</sup> Fast-Cure Urethane/Dam/Primer - Quantity 3   |                  |
| <b>Navistar</b>   |                  |
| <b>3200 Conventional Cab</b> .....  | <b>2006-2008</b> |
| <b>3300 Conventional Cab</b> .....  | <b>2006-2008</b> |
| DW01685 <sup>a b c</sup> Windshield (Encap)(Solar) (Asymmetrically Strengthened) (07-08) .....                | 30.3x80.0        |
| DW01451 <sup>a b c</sup> Windshield (Encap)(Solar) (06) .....   | 30.3x80.0        |
| DD10036-37 Door F/R-L (Solar) .....   | 19.5x24.0        |
| <sup>a</sup> May Require Two Person Installation  |                  |
| <sup>b</sup> Urethane,Dam,Primer - 2.5 Tubes  |                  |
| <sup>c</sup> Fast-Cure Urethane/Dam/Primer - Quantity 2.5   |                  |
| <b>4100 4 Door Conventional Cab</b> .....   | <b>2006-2011</b> |
| <b>4200 4 Door Conventional Cab</b> .....   | <b>2006-2008</b> |
| <b>4300 4 Door Conventional Cab</b> .....   | <b>2006-2011</b> |
| <b>4400 4 Door Conventional Cab</b> .....   | <b>2006-2011</b> |
| <b>Dura Star 4 Door Conventional Cab</b> .....  | <b>2007-2011</b> |
| DW01765 <sup>a c d</sup> Windshield (Encap)(Heated)(Solar) (Asymmetrically Strengthened) (08-11) .....        | 30.3x80.0        |
| DW01685 <sup>a c d</sup> Windshield (Encap)(Solar) (Asymmetrically Strengthened) (06-11) .....                | 30.3x80.0        |
| DW01451 <sup>a c d</sup> Windshield (Encap)(Solar) (06) .....   | 30.3x80.0        |
| DD10036-37 Door F/R-L (Solar) (06-11) .....   | 19.5x24.0        |
| DD10246-47 Door R/R-L (Solar) (06-11) .....   | 22.5x26.0        |
| DV10034-35 Vent F/R-L (Solar) (06-11) .....   | 13.0x26.5        |
| DY90111 Back Window (Encap)(Slider)(Solar) (Black Frame, 3 Piece Assembly, Aftermarket, Manual) (06-11) ..... | 18.5x57.8        |
| DB10038 <sup>b</sup> Back Window (Solar) (06-11) .....  | 18.5x57.8        |
| <sup>a</sup> May Require Two Person Installation  |                  |
| <sup>b</sup> Urethane,Dam,Primer - 1.5 Tubes  |                  |
| <sup>c</sup> Urethane,Dam,Primer - 2.5 Tubes  |                  |
| <sup>d</sup> Fast-Cure Urethane/Dam/Primer - Quantity 2.5   |                  |

|   |                  |
|---|------------------|
| <b>4100</b> Conventional Cab .....      | <b>2006-2011</b> |
| <b>4200</b> Conventional Cab .....      | <b>2006-2008</b> |
| <b>4300</b> Conventional Cab .....      | <b>2006-2011</b> |
| <b>4400</b> Conventional Cab .....      | <b>2006-2011</b> |
| <b>Dura Star</b> Conventional Cab ..... | <b>2007-2011</b> |

|  |                  |
|--|------------------|
| <b>DW01765<sup>a c d</sup></b> Windshield (Encap)(Heated)(Solar) (Asymmetrically Strengthened) (08-11) .....         | <b>30.3x80.0</b> |
| <b>DW01685<sup>a c d</sup></b> Windshield (Encap)(Solar) (Asymmetrically Strengthened) (06-11) .....                 | <b>30.3x80.0</b> |
| <b>DW01451<sup>a c d</sup></b> Windshield (Encap)(Solar) (06) .....  | <b>30.3x80.0</b> |
| <b>DD10036-37</b> Door F/R-L (Solar) (06-11) .....   | <b>19.5x24.0</b> |
| <b>DV10034-35</b> Vent F/R-L (Solar) (06-11) .....   | <b>13.0x26.5</b> |
| <b>DY90111</b> Back Window (Encap)(Slider)(Solar) (Black Frame, 3 Piece Assembly, Aftermarket, Manual) (06-11) ..... | <b>18.5x57.8</b> |
| <b>DB10038<sup>b</sup></b> Back Window (Solar) (06-11) .....   | <b>18.5x57.8</b> |

<sup>a</sup> May Require Two Person Installation  
<sup>b</sup> Urethane,Dam,Primer - 1.5 Tubes  
<sup>c</sup> Urethane,Dam,Primer - 2.5 Tubes  
<sup>d</sup> Fast-Cure Urethane/Dam/Primer - Quantity 2.5

|  |                  |
|--|------------------|
| <b>4100</b> Extended Conventional Cab .....      | <b>2006-2011</b> |
| <b>4200</b> Extended Conventional Cab .....      | <b>2006-2008</b> |
| <b>4300</b> Extended Conventional Cab .....      | <b>2006-2011</b> |
| <b>4400</b> Extended Conventional Cab .....      | <b>2006-2011</b> |
| <b>Dura Star</b> Extended Conventional Cab ..... | <b>2007-2011</b> |

|  |                  |
|--|------------------|
| <b>DW01765<sup>a c d</sup></b> Windshield (Encap)(Heated)(Solar) (Asymmetrically Strengthened) (08-11) .....         | <b>30.3x80.0</b> |
| <b>DW01685<sup>a c d</sup></b> Windshield (Encap)(Solar) (Asymmetrically Strengthened) (06-11) .....                 | <b>30.3x80.0</b> |
| <b>DW01451<sup>a c d</sup></b> Windshield (Encap)(Solar) (06) .....  | <b>30.3x80.0</b> |
| <b>DD10036-37</b> Door F/R-L (Solar) (06-11) .....   | <b>19.5x24.0</b> |
| <b>DQ10244-45</b> Quarter R-L (Solar) (Movable) (06-11) .....  | <b>19.0x23.0</b> |
| <b>DV10034-35</b> Vent F/R-L (Solar) (06-11) .....   | <b>13.0x26.5</b> |
| <b>DY90111</b> Back Window (Encap)(Slider)(Solar) (Black Frame, 3 Piece Assembly, Aftermarket, Manual) (06-11) ..... | <b>18.5x57.8</b> |
| <b>DB10038<sup>b</sup></b> Back Window (Solar) (06-11) .....   | <b>18.5x57.8</b> |

<sup>a</sup> May Require Two Person Installation  
<sup>b</sup> Urethane,Dam,Primer - 1.5 Tubes  
<sup>c</sup> Urethane,Dam,Primer - 2.5 Tubes  
<sup>d</sup> Fast-Cure Urethane/Dam/Primer - Quantity 2.5

|   |                  |
|---|------------------|
| <b>5000 I</b> 2 Door Conventional Cab .....   | <b>2006-2011</b> |
| <b>Pay Star</b> 2 Door Conventional Cab ..... | <b>2007-2011</b> |

|  |                  |
|--|------------------|
| <b>DW01664-65<sup>b c</sup></b> Windshield R-L (Encap) (Asymmetrically Strengthened) (From 01/15/2006) (06-11) .....                       | <b>28.0x39.5</b> |
| <b>DW01384-85<sup>b c</sup></b> Windshield R-L (Encap) (To 01/15/2006) (06) .....  | <b>28.0x39.5</b> |
| <b>DW01710<sup>a d e</sup></b> Windshield (Encap) (Asymmetrically Strengthened, One-Piece) (From 01/24/2007) (07-11) .....                 | <b>32.5x77.5</b> |
| <b>DW01663<sup>a d e</sup></b> Windshield (Encap) (Asymmetrically Strengthened, One-Piece) (To 01/24/2007) (From 01/15/2006) (06-07) ..... | <b>32.5x77.5</b> |
| <b>DW01383<sup>a d e</sup></b> Windshield (Encap) (One-Piece) (To 01/15/2006) (06) .....   | <b>32.5x77.5</b> |
| <b>DD10447</b> Door F/R/Lower (Encap) (Inner) (06-11) .....  | <b>10.4x14.7</b> |
| <b>DD10446</b> Door F/R/Lower (Outer) (06-11) .....  | <b>8.3x12.5</b>  |
| <b>DD10434-35</b> Door F/R-L (06-11) .....   | <b>23.0x29.0</b> |
| <b>DB10381</b> Back Window (06-11) .....   | <b>20.0x60.0</b> |

<sup>a</sup> May Require Two Person Installation  
<sup>b</sup> Urethane,Dam,Primer - 1.5 Tubes  
<sup>c</sup> Fast-Cure Urethane/Dam/Primer - Quantity 1.5  
<sup>d</sup> Urethane,Dam,Primer - 2.5 Tubes  
<sup>e</sup> Fast-Cure Urethane/Dam/Primer - Quantity 2.5

|  |                  |
|--|------------------|
| <b>7000</b> 4 Door Conventional Cab .....      | <b>2006-2011</b> |
| <b>Work Star</b> 4 Door Conventional Cab ..... | <b>2007-2011</b> |

|  |                  |
|--|------------------|
| <b>DW01765<sup>a c d</sup></b> Windshield (Encap)(Heated)(Solar) (Asymmetrically Strengthened) (08-11) .....         | <b>30.3x80.0</b> |
| <b>DW01685<sup>a c d</sup></b> Windshield (Encap)(Solar) (Asymmetrically Strengthened) (07-11) .....                 | <b>30.3x80.0</b> |
| <b>DW01451<sup>a c d</sup></b> Windshield (Encap)(Solar) (06) .....  | <b>30.3x80.0</b> |
| <b>DD10036-37</b> Door F/R-L (Solar) (06-11) .....   | <b>19.5x24.0</b> |
| <b>DD10246-47</b> Door R/R-L (Solar) (06-11) .....   | <b>22.5x26.0</b> |
| <b>DV10034-35</b> Vent F/R-L (Solar) (06-11) .....   | <b>13.0x26.5</b> |
| <b>DY90111</b> Back Window (Encap)(Slider)(Solar) (Black Frame, 3 Piece Assembly, Aftermarket, Manual) (06-11) ..... | <b>18.5x57.8</b> |
| <b>DB10038<sup>b</sup></b> Back Window (Solar) (06-11) .....   | <b>18.5x57.8</b> |

<sup>a</sup> May Require Two Person Installation  
<sup>b</sup> Urethane,Dam,Primer - 1.5 Tubes  
<sup>c</sup> Urethane,Dam,Primer - 2.5 Tubes  
<sup>d</sup> Fast-Cure Urethane/Dam/Primer - Quantity 2.5

|   |                  |
|---|------------------|
| <b>7000</b> Conventional Cab .....      | <b>2006-2011</b> |
| <b>Work Star</b> Conventional Cab ..... | <b>2007-2011</b> |

|  |                  |
|--|------------------|
| <b>DW01765<sup>a c d</sup></b> Windshield (Encap)(Heated)(Solar) (Asymmetrically Strengthened) (08-11) .....         | <b>30.3x80.0</b> |
| <b>DW01685<sup>a c d</sup></b> Windshield (Encap)(Solar) (Asymmetrically Strengthened) (07-11) .....                 | <b>30.3x80.0</b> |
| <b>DW01451<sup>a c d</sup></b> Windshield (Encap)(Solar) (06) .....  | <b>30.3x80.0</b> |
| <b>DD10036-37</b> Door F/R-L (Solar) (06-11) .....   | <b>19.5x24.0</b> |
| <b>DV10034-35</b> Vent F/R-L (Solar) (06-11) .....   | <b>13.0x26.5</b> |
| <b>DY90111</b> Back Window (Encap)(Slider)(Solar) (Black Frame, 3 Piece Assembly, Aftermarket, Manual) (06-11) ..... | <b>18.5x57.8</b> |
| <b>DB10038<sup>b</sup></b> Back Window (Solar) (06-11) .....   | <b>18.5x57.8</b> |

<sup>a</sup> May Require Two Person Installation  
<sup>b</sup> Urethane,Dam,Primer - 1.5 Tubes  
<sup>c</sup> Urethane,Dam,Primer - 2.5 Tubes  
<sup>d</sup> Fast-Cure Urethane/Dam/Primer - Quantity 2.5

|  |                  |
|--|------------------|
| <b>7000</b> Extended Conventional Cab .....      | <b>2006-2011</b> |
| <b>Work Star</b> Extended Conventional Cab ..... | <b>2007-2011</b> |

|  |                  |
|--|------------------|
| <b>DW01765<sup>a c d</sup></b> Windshield (Encap)(Heated)(Solar) (Asymmetrically Strengthened) (08-11) .....         | <b>30.3x80.0</b> |
| <b>DW01685<sup>a c d</sup></b> Windshield (Encap)(Solar) (Asymmetrically Strengthened) (07-11) .....                 | <b>30.3x80.0</b> |
| <b>DW01451<sup>a c d</sup></b> Windshield (Encap)(Solar) (06) .....  | <b>30.3x80.0</b> |
| <b>DD10036-37</b> Door F/R-L (Solar) (06-11) .....   | <b>19.5x24.0</b> |
| <b>DQ10244-45</b> Quarter R-L (Solar) (Movable) (06-11) .....  | <b>19.0x23.0</b> |
| <b>DV10034-35</b> Vent F/R-L (Solar) (06-11) .....   | <b>13.0x26.5</b> |
| <b>DY90111</b> Back Window (Encap)(Slider)(Solar) (Black Frame, 3 Piece Assembly, Aftermarket, Manual) (06-11) ..... | <b>18.5x57.8</b> |
| <b>DB10038<sup>b</sup></b> Back Window (Solar) (06-11) .....   | <b>18.5x57.8</b> |

<sup>a</sup> May Require Two Person Installation  
<sup>b</sup> Urethane,Dam,Primer - 1.5 Tubes  
<sup>c</sup> Urethane,Dam,Primer - 2.5 Tubes  
<sup>d</sup> Fast-Cure Urethane/Dam/Primer - Quantity 2.5

|   |                  |
|---|------------------|
| <b>8000</b> Conventional Cab .....      | <b>2006-2011</b> |
| <b>Tran Star</b> Conventional Cab ..... | <b>2007-2011</b> |

|  |                  |
|--|------------------|
| <b>DW01765<sup>a c d</sup></b> Windshield (Encap)(Heated)(Solar) (Asymmetrically Strengthened) (08-11) .....         | <b>30.3x80.0</b> |
| <b>DW01685<sup>a c d</sup></b> Windshield (Encap)(Solar) (Asymmetrically Strengthened) (07-11) .....                 | <b>30.3x80.0</b> |
| <b>DW01451<sup>a c d</sup></b> Windshield (Encap)(Solar) (06) .....  | <b>30.3x80.0</b> |
| <b>DD10036-37</b> Door F/R-L (Solar) (06-11) .....   | <b>19.5x24.0</b> |
| <b>DV10034-35</b> Vent F/R-L (Solar) (06-11) .....   | <b>13.0x26.5</b> |
| <b>DY90111</b> Back Window (Encap)(Slider)(Solar) (Black Frame, 3 Piece Assembly, Aftermarket, Manual) (06-11) ..... | <b>18.5x57.8</b> |

|  |                  |
|--|------------------|
| <b>8000</b>  | <i>(cont.)</i>   |
| <b>DB10038<sup>b</sup></b> Back Window (Solar) (06-11) .....   | <b>18.5x57.8</b> |
| <sup>a</sup> May Require Two Person Installation<br><sup>b</sup> Urethane,Dam,Primer - 1.5 Tubes<br><sup>c</sup> Urethane,Dam,Primer - 2.5 Tubes<br><sup>d</sup> Fast-Cure Urethane/Dam/Primer - Quantity 2.5  |                  |
| <b>8000</b> Extended Conventional Cab.....   | <b>2006-2011</b> |
| <b>Tran Star</b> Extended Conventional Cab .....   | <b>2007-2011</b> |
| <b>DW01765<sup>a c d</sup></b> Windshield (Encap)(Heated)(Solar) (Asymmetrically Strengthened) (08-11) .....   | <b>30.3x80.0</b> |
| <b>DW01685<sup>a c d</sup></b> Windshield (Encap)(Solar) (Asymmetrically Strengthened) (07-11) .....   | <b>30.3x80.0</b> |
| <b>DW01451<sup>a c d</sup></b> Windshield (Encap)(Solar) (06) .....  | <b>30.3x80.0</b> |
| <b>DD10036-37</b> Door F/R-L (Solar) (06-11) .....   | <b>19.5x24.0</b> |
| <b>DQ10244-45</b> Quarter R-L (Solar) (Movable) (06-11) .....  | <b>19.0x23.0</b> |
| <b>DV10034-35</b> Vent F/R-L (Solar) (06-11) .....   | <b>13.0x26.5</b> |
| <b>DY90111</b> Back Window (Encap)(Slider)(Solar) (Black Frame, 3 Piece Assembly, Aftermarket, Manual) (06-11) .....   | <b>18.5x57.8</b> |
| <b>DB10038<sup>b</sup></b> Back Window (Solar) (06-11) .....   | <b>18.5x57.8</b> |
| <sup>a</sup> May Require Two Person Installation<br><sup>b</sup> Urethane,Dam,Primer - 1.5 Tubes<br><sup>c</sup> Urethane,Dam,Primer - 2.5 Tubes<br><sup>d</sup> Fast-Cure Urethane/Dam/Primer - Quantity 2.5  |                  |
| <b>9100 i</b> 2 Door Conventional Cab .....  | <b>2006-2007</b> |
| <b>9200 i</b> 2 Door Conventional Cab .....  | <b>2006-2011</b> |
| <b>9400 i</b> 2 Door Conventional Cab .....  | <b>2006-2007</b> |
| <b>9900 i</b> 2 Door Conventional Cab .....  | <b>2006-2011</b> |
| <b>9900 ix</b> 2 Door Conventional Cab .....   | <b>2006-2011</b> |
| <b>DW01664-65<sup>b c</sup></b> Windshield R-L (Encap) (Asymmetrically Strengthened) (From 01/25/2006) (06-11) .....   | <b>28.0x39.5</b> |
| <b>DW01384-85<sup>b c</sup></b> Windshield R-L (Encap) (To 01/25/2006) (06) .....  | <b>28.0x39.5</b> |
| <b>DW01710<sup>a d e</sup></b> Windshield (Encap) (Asymmetrically Strengthened, One-Piece) (From 01/24/2007) (07-11) .....   | <b>32.5x77.5</b> |
| <b>DW01663<sup>a d e</sup></b> Windshield (Encap) (Asymmetrically Strengthened, One-Piece) (From 01/25/2006) (To 01/24/2007) (06-07) .....   | <b>32.5x77.5</b> |
| <b>DW01383<sup>a d e</sup></b> Windshield (Encap) (One-Piece) (To 01/25/2006) (06) .....   | <b>32.5x77.5</b> |
| <b>DD10447</b> Door F/R/Lower (Encap) (Inner) (06-11) .....  | <b>10.4x14.7</b> |
| <b>DD10446</b> Door F/R/Lower (Outer) (06-11) .....  | <b>8.3x12.5</b>  |
| <b>DD10434-35</b> Door F/R-L (06-11) .....   | <b>23.0x29.0</b> |
| <b>DB10381</b> Back Window (06-11) .....   | <b>20.0x60.0</b> |
| <sup>a</sup> May Require Two Person Installation<br><sup>b</sup> Urethane,Dam,Primer - 1.5 Tubes<br><sup>c</sup> Fast-Cure Urethane/Dam/Primer - Quantity 1.5<br><sup>d</sup> Urethane,Dam,Primer - 2.5 Tubes<br><sup>e</sup> Fast-Cure Urethane/Dam/Primer - Quantity 2.5 |                  |
| <b>CE Series</b> Bus.....  | <b>2006-2011</b> |
| <b>DW01646<sup>b c</sup></b> Windshield R-L/Outer (Tempered) .....   |                  |
| <b>DW01645<sup>a d e</sup></b> Windshield .....  | <b>28.5x84.9</b> |
| <sup>a</sup> May Require Two Person Installation<br><sup>b</sup> Urethane,Dam,Primer - 2 Tubes<br><sup>c</sup> Fast-Cure Urethane/Dam/Primer - Quantity 2<br><sup>d</sup> Urethane,Dam,Primer - 2.5 Tubes<br><sup>e</sup> Fast-Cure Urethane/Dam/Primer - Quantity 2.5     |                  |

|   |                  |
|---|------------------|
| <b>CF 500</b> Cab Forward .....   | <b>2006-2011</b> |
| <b>CF 600</b> Cab Forward .....   | <b>2006-2011</b> |
| <b>City Star</b> Cab Forward.....   | <b>2007-2011</b> |
| <b>DW01615<sup>a b c</sup></b> Windshield (Encap) (06-11) .....   | <b>31.0x76.0</b> |
| <b>DD10909-10</b> Door F/R-L (06-11) .....  | <b>30.5x34.3</b> |
| <b>DB10911</b> Back Window (Gasket Set) (06-11) .....   | <b>14.0x35.0</b> |
| <sup>a</sup> May Require Two Person Installation<br><sup>b</sup> Urethane,Dam,Primer - 2 Tubes<br><sup>c</sup> Fast-Cure Urethane/Dam/Primer - Quantity 2   |                  |
| <b>CXT</b> 4 Door Conventional Cab.....   | <b>2006-2009</b> |
| <b>MXT</b> 4 Door Conventional Cab.....   | <b>2007-2011</b> |
| <b>RXT</b> 4 Door Conventional Cab.....   | <b>2007-2009</b> |
| <b>DW01685<sup>a c d</sup></b> Windshield (Encap)(Solar) (Asymmetrically Strengthened) (06-11) .....  | <b>30.3x80.0</b> |
| <b>DD10036-37</b> Door F/R-L (Solar) (06-11) .....  | <b>19.5x24.0</b> |
| <b>DD10246-47</b> Door R/R-L (Solar) (06-11) .....  | <b>22.5x26.0</b> |
| <b>DV10034-35</b> Vent F/R-L (Solar) (06-11) .....  | <b>13.0x26.5</b> |
| <b>DY90111</b> Back Window (Encap)(Slider)(Solar) (Black Frame, 3 Piece Assembly, Aftermarket, Manual) (06-11) .....  | <b>18.5x57.8</b> |
| <b>DB10038<sup>b</sup></b> Back Window (Solar) (06-11) .....  | <b>18.5x57.8</b> |
| <sup>a</sup> May Require Two Person Installation<br><sup>b</sup> Urethane,Dam,Primer - 1.5 Tubes<br><sup>c</sup> Urethane,Dam,Primer - 2.5 Tubes<br><sup>d</sup> Fast-Cure Urethane/Dam/Primer - Quantity 2.5 |                  |
| <b>Lone Star</b> Conventional Cab.....  | <b>2008-2010</b> |
| <b>DW01831<sup>a b c</sup></b> Windshield (Encap)(Solar) (W/Third Visor Frit, Asymmetrically Strengthened) (10) .....   | <b>30.3x80.0</b> |
| <b>DW01770<sup>a b c</sup></b> Windshield (Encap)(Solar) (Asymmetrically Strengthened) (08-09) .....  | <b>30.3x80.0</b> |
| <sup>a</sup> May Require Two Person Installation<br><sup>b</sup> Urethane,Dam,Primer - 2.5 Tubes<br><sup>c</sup> Fast-Cure Urethane/Dam/Primer - Quantity 2.5   |                  |
| <b>Pro Star</b> 2 Door Conventional Cab .....   | <b>2007-2011</b> |
| <b>DW01765<sup>a b c</sup></b> Windshield (Encap)(Heated)(Solar) (Asymmetrically Strengthened) (08-11) .....  | <b>30.3x80.0</b> |
| <b>DW01685<sup>a b c</sup></b> Windshield (Encap)(Solar) (Asymmetrically Strengthened) .....  | <b>30.3x80.0</b> |
| <b>DD10036-37</b> Door F/R-L (Solar) .....  | <b>19.5x24.0</b> |
| <b>DQ11580</b> Quarter R-L (Encap)(Solar) (Assembly, Sleeper Cab) .....   |                  |
| <b>DV10034-35</b> Vent F/R-L (Solar) .....  | <b>13.0x26.5</b> |
| <sup>a</sup> May Require Two Person Installation<br><sup>b</sup> Urethane,Dam,Primer - 2.5 Tubes<br><sup>c</sup> Fast-Cure Urethane/Dam/Primer - Quantity 2.5   |                  |
| <b>Nissan</b>   |                  |
| <b>Cabstar</b> Cab Over Engine (MEXICO Only).....   | <b>2007-2011</b> |
| <b>FW02920<sup>a b c</sup></b> Windshield (Solar) (W/Third Visor Frit, Mexico Only)   |                  |
| <b>FD23763-64</b> Door F/R-L (Solar) (Mexico Only) .....  |                  |
| <b>FB23765<sup>d</sup></b> Back Window (Solar) (Mexico Only) .....  |                  |
| <sup>a</sup> May Require Two Person Installation<br><sup>b</sup> Urethane,Dam,Primer - 2 Tubes<br><sup>c</sup> Fast-Cure Urethane/Dam/Primer - Quantity 2<br><sup>d</sup> Urethane,Dam,Primer - 1.5 Tubes     |                  |

|   |                   |
|---|-------------------|
| <b>UD 1300 Cabover</b> .....  | <b>2006-2007</b>  |
| <b>UD 1400 Cabover</b> .....  | <b>2006-2011</b>  |
| <b>FW00752<sup>a b c</sup> Windshield (06-11)</b> .....                   | <b>28.3x71.8</b>  |
| <b>FD22424 Door F/L (06-11)</b> .....                                     | <b>23.8x40.0</b>  |
| <b>FD22423 Door F/R (06-11)</b> .....                                     | <b>26.5x40.5</b>  |
| <b>FB23568<sup>d</sup> Back Window (Solar) (Stationary) (06-11)</b> ..... | <b>10.8x39.0</b>  |
| <sup>a</sup> May Require Two Person Installation                          |                   |
| <sup>b</sup> Urethane,Dam,Primer - 2 Tubes                                |                   |
| <sup>c</sup> Fast-Cure Urethane/Dam/Primer - Quantity 2                   |                   |
| <sup>d</sup> Urethane,Dam,Primer - 1 Tube                                 |                   |
| <b>UD 1800CS Cabover</b> .....  | <b>2006-2011</b>  |
| <b>UD 1800HD Cabover</b> .....  | <b>2006-2011</b>  |
| <b>UD 2000 Cabover</b> .....  | <b>2006-2011</b>  |
| <b>UD 2300DH Cabover</b> .....  | <b>2006-2011</b>  |
| <b>UD 2300LP Cabover</b> .....  | <b>2006-2011</b>  |
| <b>UD 2600 Cabover</b> .....  | <b>2006-2011</b>  |
| <b>UD 2600LP Cabover</b> .....  | <b>2010-2011</b>  |
| <b>UD 3300 Cabover</b> .....  | <b>2006-2011</b>  |
| <b>FW00813<sup>a c d</sup> Windshield (06-11)</b> .....                   | <b>32.5x77.1</b>  |
| <b>FD23339-40 Door F/R-L (06-11)</b> .....                                | <b>19.5x24.5</b>  |
| <b>FQ24881-82<sup>b</sup> Quarter R-L (Stationary) (06-11)</b> .....      |                   |
| <b>FQ23189-90 Quarter R-L (Movable) (06-11)</b> .....                     |                   |
| <b>FV23341-42<sup>b</sup> Vent F/R-L (Stationary) (06-11)</b> .....       |                   |
| <b>FV23185-86 Vent F/R-L (Movable) (06-11)</b> .....                      |                   |
| <b>FB23343<sup>b</sup> Back Window (06-11)</b> .....                      |                   |
| <sup>a</sup> May Require Two Person Installation                          |                   |
| <sup>b</sup> Urethane,Dam,Primer - 1.5 Tubes                              |                   |
| <sup>c</sup> Urethane,Dam,Primer - 2.5 Tubes                              |                   |
| <sup>d</sup> Fast-Cure Urethane/Dam/Primer - Quantity 2.5                 |                   |
| <b>Peterbilt</b>  |                   |
| <b>210 Cabover</b> .....  | <b>2007-2010</b>  |
| <b>220 Cabover</b> .....  | <b>2007-2010</b>  |
| <b>DW01799<sup>a b</sup> Windshield</b> .....                             | <b>27.3x100.4</b> |
| <b>DD11684-85 Door F/R-L</b> .....  |                   |
| <sup>a</sup> Urethane,Dam,Primer - 2.5 Tubes                              |                   |
| <sup>b</sup> Fast-Cure Urethane/Dam/Primer - Quantity 2.5                 |                   |
| <b>320 Cabover</b> .....  | <b>2006-2010</b>  |
| <b>DW01304<sup>a b</sup> Windshield R-L (Two-Piece)</b> .....             | <b>32.0x44.0</b>  |
| <b>DT02766 Door F/R/Lower</b> .....                                       | <b>14.0x14.0</b>  |
| <b>DT04675 Door F/R-L (Movable)</b> .....                                 | <b>18.0x18.0</b>  |
| <b>DT02765 Door R/R-L (Movable)</b> .....                                 | <b>11.0x18.0</b>  |
| <b>DT02768 Back Window (Stationary)</b> .....                             | <b>15.0x18.0</b>  |
| <b>DT02767 Back Window (Movable)</b> .....                                | <b>15.0x19.0</b>  |
| <b>DT01160 Back Window</b> .....  | <b>17.0x39.0</b>  |
| <sup>a</sup> Urethane,Dam,Primer - 1.5 Tubes                              |                   |
| <sup>b</sup> Fast-Cure Urethane/Dam/Primer - Quantity 1.5                 |                   |
| <b>325 Conventional Cab</b> .....   | <b>2008-2010</b>  |
| <b>335 Conventional Cab</b> .....   | <b>2006-2009</b>  |
| <b>337 Conventional Cab</b> .....   | <b>2010</b>       |
| <b>DW01036-37<sup>b</sup> Windshield R-L (Encap) (06-10)</b> .....        | <b>20.0x31.0</b>  |
| <b>DD11316-17 Door F/R-L (06-10)</b> .....                                |                   |
| <b>DT02674 Door F/R/Lower (06-10)</b> .....                               | <b>7.0x15.0</b>   |

|  |                  |
|--|------------------|
| <b>325</b>   | <b>(cont.)</b>   |
| <b>DB11190<sup>a</sup> Back Window (Day Cab) (06-10)</b> .....     | <b>19.0x54.6</b> |
| <b>DT04749 Back Window (06-10)</b> .....                           | <b>19.0x36.0</b> |
| <sup>a</sup> Urethane,Dam,Primer - 1.5 Tubes                       |                  |
| <sup>b</sup> Foam Core Butyl Tape - Quantity 1                     |                  |
| <b>330 Conventional Cab</b> .....                                  | <b>2006-2010</b> |
| <b>340 Conventional Cab</b> .....                                  | <b>2007-2009</b> |
| <b>348 Conventional Cab</b> .....                                  | <b>2010</b>      |
| <b>357 Conventional Cab</b> .....                                  | <b>2006-2007</b> |
| <b>365 Conventional Cab</b> .....                                  | <b>2008-2010</b> |
| <b>367 Conventional Cab</b> .....                                  | <b>2008-2010</b> |
| <b>378 Conventional Cab</b> .....                                  | <b>2006-2007</b> |
| <b>379 Conventional Cab</b> .....                                  | <b>2006-2007</b> |
| <b>384 Conventional Cab</b> .....                                  | <b>2008-2010</b> |
| <b>385 Conventional Cab</b> .....                                  | <b>2006-2007</b> |
| <b>386 Conventional Cab</b> .....                                  | <b>2006-2010</b> |
| <b>388 Conventional Cab</b> .....                                  | <b>2008-2010</b> |
| <b>389 Conventional Cab</b> .....                                  | <b>2008-2010</b> |
| <b>DW01036-37<sup>b</sup> Windshield R-L (Encap) (06-10)</b> ..... | <b>20.0x31.0</b> |
| <b>DT02674 Door F/R/Lower (06-10)</b> .....                        | <b>7.0x15.0</b>  |
| <b>DD11614 Door F/R-L (W/O Vent) (06-10)</b> .....                 | <b>22.1x29.2</b> |
| <b>DT04614 Door F/R-L (06-10)</b> .....                            | <b>21.0x21.0</b> |
| <b>DT02692 Vent F/R-L (06-10)</b> .....                            | <b>9.0x17.0</b>  |
| <b>DB11190<sup>a</sup> Back Window (Day Cab) (06-10)</b> .....     | <b>19.0x54.6</b> |
| <b>DT04749 Back Window (06-10)</b> .....                           | <b>19.0x36.0</b> |
| <sup>a</sup> Urethane,Dam,Primer - 1.5 Tubes                       |                  |
| <sup>b</sup> Foam Core Butyl Tape - Quantity 1                     |                  |
| <b>387 Conventional Cab</b> .....                                  | <b>2006-2010</b> |
| <b>DW01310<sup>a b c</sup> Windshield</b> .....                    | <b>28.0x84.0</b> |
| <b>DD09256-57 Door F/R-L</b> .....                                 | <b>19.0x26.0</b> |
| <b>DV09254-55 Vent F/R-L</b> .....                                 | <b>14.3x28.0</b> |
| <sup>a</sup> May Require Two Person Installation                   |                  |
| <sup>b</sup> Urethane,Dam,Primer - 2.5 Tubes                       |                  |
| <sup>c</sup> Fast-Cure Urethane/Dam/Primer - Quantity 2.5          |                  |
| <b>Peterbilt</b>   |                  |
| <b>H3 Bus</b> .....  | <b>2006-2008</b> |
| <b>DW01779-80<sup>a b c</sup> Windshield R-L</b> .....             | <b>49.7x65.0</b> |
| <sup>a</sup> May Require Two Person Installation                   |                  |
| <sup>b</sup> Urethane,Dam,Primer - 2.5 Tubes                       |                  |
| <sup>c</sup> Fast-Cure Urethane/Dam/Primer - Quantity 2.5          |                  |
| <b>LeMirage Bus</b> .....  | <b>2006-2008</b> |
| <b>DW01497<sup>a b</sup> Windshield R-L</b> .....                  | <b>34.0x47.0</b> |
| <b>DS10276 Side R-L (Laminated)</b> .....                          | <b>34.0x44.0</b> |
| <sup>a</sup> Urethane,Dam,Primer - 1.5 Tubes                       |                  |
| <sup>b</sup> Fast-Cure Urethane/Dam/Primer - Quantity 1.5          |                  |

| <b>Scania</b>   |                  |
|---|------------------|
| <b>P Series Cab Over Engine (MEXICO Only) .....</b>       | <b>2006-2011</b> |
| <b>FW02922<sup>a</sup></b> Windshield (Mexico Only) ..... |                  |
| <b>FD23773-74</b> Door F/R-L (Mexico Only) .....          |                  |
| <b>FB23775</b> Back Window (Mexico Only) .....            |                  |
| <sup>a</sup> May Require Two Person Installation          |                  |

| <b>Sterling Trucks</b>                                  |                  |
|---|------------------|
| <b>360 Cabover .....</b>                                | <b>2007-2009</b> |
| <b>FW02541<sup>a b c</sup></b> Windshield .....         | <b>30.5x72.5</b> |
| <b>FD24434-35</b> Door F/R-L .....                      |                  |
| <b>FB24438</b> Back Window .....                        |                  |
| <sup>a</sup> May Require Two Person Installation        |                  |
| <sup>b</sup> Urethane,Dam,Primer - 2 Tubes              |                  |
| <sup>c</sup> Fast-Cure Urethane/Dam/Primer - Quantity 2 |                  |

|   |                  |
|---|------------------|
| <b>A/AT Series Conventional Cab .....</b>                     | <b>2006-2009</b> |
| <b>Acterra Conventional Cab .....</b>                         | <b>2006-2009</b> |
| <b>L Series/Heavy Duty Conventional Cab .....</b>             | <b>2006-2009</b> |
| <b>DW01254<sup>a b c</sup></b> Windshield (Solar) .....       | <b>27.0x71.6</b> |
| <b>DD08989</b> Door F/R/Lower (Solar) .....                   | <b>9.5x12.8</b>  |
| <b>DD08987-88</b> Door F/R-L (2 Holes)(Solar) .....           | <b>25.8x30.1</b> |
| <b>DV09766-67</b> Vent F/R-L (3 Holes) .....                  | <b>8.0x24.5</b>  |
| <b>DV08985-86</b> Vent F/R-L (3 Holes)(Solar) .....           | <b>8.0x24.5</b>  |
| <b>DB11065-66</b> Back Window R-L (Aftermarket, Curved) ..... | <b>14.8x26.0</b> |
| <b>DT04775</b> Back Window R-L .....                          | <b>14.8x26.0</b> |
| <sup>a</sup> May Require Two Person Installation              |                  |
| <sup>b</sup> Urethane,Dam,Primer - 2 Tubes                    |                  |
| <sup>c</sup> Fast-Cure Urethane/Dam/Primer - Quantity 2       |                  |

|  |                  |
|--|------------------|
| <b>Bullet 2 Door Conventional Cab .....</b>  | <b>2008-2009</b> |
| <b>DW01512<sup>a c d</sup></b> Windshield (W/Third Visor Frit) .....   | <b>39.0x68.0</b> |
| <b>DD10071-72</b> Door F/R-L .....   | <b>27.0x36.0</b> |
| <b>DB10996<sup>b</sup></b> Back Window C (Solar) (OE, Power) .....   | <b>16.0x16.0</b> |
| <b>DB10995<sup>b</sup></b> Back Window C (Solar) (OE, Movable) .....   | <b>16.0x16.0</b> |
| <b>DY90113<sup>c</sup></b> Back Window (Slider)(Solar) (Aftermarket, 1 Panel Flush Fit, Manual) .....                    | <b>19.4x65.5</b> |
| <b>DY90104<sup>c</sup></b> Back Window (Encap)(Slider)(Solar) (Black Frame, 3 Piece Assembly, Aftermarket, Power) .....  | <b>19.4x65.5</b> |
| <b>DY90103<sup>c</sup></b> Back Window (Encap)(Slider)(Solar) (Black Frame, 3 Piece Assembly, Aftermarket, Manual) ..... | <b>19.4x65.5</b> |
| <b>DY90102<sup>c</sup></b> Back Window (Encap)(Slider) (Black Frame, 3 Piece Assembly, Aftermarket, Manual) .....        | <b>19.4x65.5</b> |
| <b>DB10941<sup>b c</sup></b> Back Window (Encap)(Slider)(Solar) (OE, Power) ....   | <b>19.4x65.5</b> |
| <b>DB10940<sup>b c</sup></b> Back Window (Encap)(Slider)(Solar) (OE, Manual) ...   | <b>19.4x65.5</b> |
| <b>DB10533<sup>c</sup></b> Back Window (Encap)(Heated)(Solar) (Stationary) ....  | <b>17.5x64.5</b> |
| <b>DB10077<sup>c</sup></b> Back Window (Encap)(Solar) (Stationary) .....   | <b>17.5x64.5</b> |
| <sup>a</sup> May Require Two Person Installation   |                  |
| <sup>b</sup> Not On Production Vehicles  |                  |
| <sup>c</sup> Urethane,Dam,Primer - 2 Tubes   |                  |
| <sup>d</sup> Fast-Cure Urethane/Dam/Primer - Quantity 2  |                  |

|  |                  |
|--|------------------|
| <b>Bullet 4 Door Conventional Cab .....</b>                          | <b>2008-2009</b> |
| <b>DW01512<sup>a c d</sup></b> Windshield (W/Third Visor Frit) ..... | <b>39.0x68.0</b> |
| <b>DD10073-74</b> Door F/R-L .....                                   | <b>27.0x32.0</b> |
| <b>DD10075-76</b> Door R/R-L (Solar) .....                           | <b>23.5x27.0</b> |
| <b>DB10996<sup>b</sup></b> Back Window C (Solar) (OE, Power) .....   | <b>16.0x16.0</b> |

|  |                  |
|--|------------------|
| <b>Bullet</b>  | <b>(cont.)</b>   |
| <b>DB10995<sup>b</sup></b> Back Window C (Solar) (OE, Movable) .....   | <b>16.0x16.0</b> |
| <b>DY90113<sup>c</sup></b> Back Window (Slider)(Solar) (Aftermarket, 1 Panel Flush Fit, Manual) .....                    | <b>19.4x65.5</b> |
| <b>DY90104<sup>c</sup></b> Back Window (Encap)(Slider)(Solar) (Black Frame, 3 Piece Assembly, Aftermarket, Power) .....  | <b>19.4x65.5</b> |
| <b>DY90103<sup>c</sup></b> Back Window (Encap)(Slider)(Solar) (Black Frame, 3 Piece Assembly, Aftermarket, Manual) ..... | <b>19.4x65.5</b> |
| <b>DY90102<sup>c</sup></b> Back Window (Encap)(Slider) (Black Frame, 3 Piece Assembly, Aftermarket, Manual) .....        | <b>19.4x65.5</b> |
| <b>DB10941<sup>b c</sup></b> Back Window (Encap)(Slider)(Solar) (OE, Power) ....   | <b>19.4x65.5</b> |
| <b>DB10940<sup>b c</sup></b> Back Window (Encap)(Slider)(Solar) (OE, Manual) ..  | <b>19.4x65.5</b> |
| <b>DB10533<sup>c</sup></b> Back Window (Encap)(Heated)(Solar) (Stationary) ...   | <b>17.5x64.5</b> |
| <b>DB10077<sup>c</sup></b> Back Window (Encap)(Solar) (Stationary) .....   | <b>17.5x64.5</b> |
| <sup>a</sup> May Require Two Person Installation   |                  |
| <sup>b</sup> Not On Production Vehicles  |                  |
| <sup>c</sup> Urethane,Dam,Primer - 2 Tubes   |                  |
| <sup>d</sup> Fast-Cure Urethane/Dam/Primer - Quantity 2  |                  |

|  |                  |
|--|------------------|
| <b>Cargo Cabover .....</b>   | <b>2006-2008</b> |
| <b>DW01439<sup>b c</sup></b> Windshield R-L (Right Or Left, Two-Piece) ..... | <b>37.2x45.4</b> |
| <b>DW00997<sup>a d e</sup></b> Windshield (One-Piece) .....                  | <b>32.8x75.8</b> |
| <b>DD07017-18</b> Door F/R-L (Movable) .....                                 | <b>23.0x26.0</b> |
| <b>DT02804</b> Door F/R-L .....  | <b>7.0x24.0</b>  |
| <b>DV07015-16</b> Vent F/R-L (Stationary) .....                              | <b>13.0x45.0</b> |
| <b>DT04733</b> Back Window R-L .....   | <b>19.0x33.0</b> |
| <sup>a</sup> May Require Two Person Installation                             |                  |
| <sup>b</sup> Urethane,Dam,Primer - 2 Tubes                                   |                  |
| <sup>c</sup> Fast-Cure Urethane/Dam/Primer - Quantity 2                      |                  |
| <sup>d</sup> Urethane,Dam,Primer - 2.5 Tubes                                 |                  |
| <sup>e</sup> Fast-Cure Urethane/Dam/Primer - Quantity 2.5                    |                  |

|  |                  |
|--|------------------|
| <b>Condor Cabover/Cargo Truck .....</b>                                      | <b>2006</b>      |
| <b>DW01439<sup>a b</sup></b> Windshield R-L (Right Or Left, Two-Piece) ..... | <b>37.2x45.4</b> |
| <b>DT09936</b> Door F/R-L (Right Or Left) .....                              |                  |
| <b>DQ09937</b> Quarter R-L .....   |                  |
| <b>DB09938</b> Back Window .....   | <b>20.0x36.0</b> |
| <sup>a</sup> Urethane,Dam,Primer - 2 Tubes                                   |                  |
| <sup>b</sup> Fast-Cure Urethane/Dam/Primer - Quantity 2                      |                  |

| <b>Thomas</b>  |                  |
|--|------------------|
| <b>Saf-T-Liner C2 Bus .....</b>  | <b>2006-2011</b> |
| <b>DW01753<sup>a c d</sup></b> Windshield (One-Piece, 9.5" Shade Band) ..... | <b>43.0x82.0</b> |
| <b>DW01752<sup>a b c d</sup></b> Windshield (One-Piece) .....                | <b>43.0x82.0</b> |
| <sup>a</sup> May Require Two Person Installation                             |                  |
| <sup>b</sup> GBN Has 6" Shade Band   |                  |
| <sup>c</sup> Urethane,Dam,Primer - 2.5 Tubes                                 |                  |
| <sup>d</sup> Fast-Cure Urethane/Dam/Primer - Quantity 2.5                    |                  |

|                                  |                  |
|----------------------------------|------------------|
| <b>Saf-T-Liner EF Bus .....</b>  | <b>2006-2011</b> |
| <b>Saf-T-Liner HDX Bus .....</b> | <b>2006-2011</b> |

|   |                  |
|---|------------------|
| <b>DW01750-51<sup>a b</sup></b> Windshield R-L .....    | <b>44.0x46.0</b> |
| <sup>a</sup> Urethane,Dam,Primer - 2 Tubes              |                  |
| <sup>b</sup> Fast-Cure Urethane/Dam/Primer - Quantity 2 |                  |



| <b>Utilimaster</b>   |                                |
|--|--------------------------------|
| <b>Aeromaster Step Van</b> .....   | <b>2006-2011</b>               |
| DW01821 <sup>b,c</sup> Windshield L/Outer (Tempered) .....   | 23.5x34.0                      |
| DW01650 <sup>b,c</sup> Windshield L/Outer (Tempered) .....   | 21.3x34.0                      |
| DW01820 <sup>b,c</sup> Windshield R/Outer (Tempered) .....   | 23.5x34.0                      |
| DW01649 <sup>b,c</sup> Windshield R/Outer (Tempered) .....   | 21.3x34.0                      |
| DW01676 <sup>b,c</sup> Windshield R-L (93.5" Body Width) .....   | 35.5x45.5                      |
| DW01648 <sup>b,c</sup> Windshield R-L (86.5" Body Width) .....   | 35.5x42.0                      |
| DW01677 <sup>a,d,e</sup> Windshield (78.5" Body Width, One-Piece) .....  | 35.5x76.3                      |
| <sup>a</sup> May Require Two Person Installation<br><sup>b</sup> Urethane,Dam,Primer - 1.5 Tubes<br><sup>c</sup> Fast-Cure Urethane/Dam/Primer - Quantity 1.5<br><sup>d</sup> Urethane,Dam,Primer - 2.5 Tubes<br><sup>e</sup> Fast-Cure Urethane/Dam/Primer - Quantity 2.5 |                                |
| <b>FFV Postal Van Step Van</b> .....   | <b>2006-2011</b><br>(USA Only) |
| DW01483 <sup>a,b</sup> Windshield .....  | 27.1x65.4                      |
| <sup>a</sup> Urethane,Dam,Primer - 2 Tubes<br><sup>b</sup> Fast-Cure Urethane/Dam/Primer - Quantity 2  |                                |
| <b>Volkswagen</b>  |                                |
| <b>15-190 Cabover (MEXICO Only)</b> .....  | <b>2006-2010</b>               |
| <b>17-250 Cabover (MEXICO Only)</b> .....  | <b>2006-2010</b>               |
| <b>24-250 Cabover (MEXICO Only)</b> .....  | <b>2006-2010</b>               |
| <b>8-150 Cabover (MEXICO Only)</b> .....   | <b>2006-2010</b>               |
| FW02700 <sup>a,b</sup> Windshield (Mexico Only) .....  | .....                          |
| FD23248 Door F/R-L (Mexico Only) .....   | .....                          |
| FV23247 Vent F/L (3 Holes) (Mexico Only) .....   | .....                          |
| FV23246 <sup>c</sup> Vent F/R (3 Holes) (Mexico Only) .....  | .....                          |
| FB23310 Back Window (Mexico Only) .....  | .....                          |
| <sup>a</sup> Urethane,Dam,Primer - 2 Tubes<br><sup>b</sup> Fast-Cure Urethane/Dam/Primer - Quantity 2<br><sup>c</sup> Urethane,Dam,Primer - 1.5 Tubes  |                                |
| <b>Volvo</b>   |                                |
| <b>VHD Series Conventional Cab</b> .....   | <b>2006-2011</b>               |
| <b>VN Series Conventional Cab</b> .....  | <b>2006-2011</b>               |
| <b>VT Series Conventional Cab</b> .....  | <b>2006-2010</b>               |
| DW01882 <sup>b,c</sup> Windshield (Heated)(Solar) (Heated Wiper Park Area) (10-11) .....   | 29.1x79.9                      |
| DW01525 <sup>a,b,c</sup> Windshield (Solar) (06-11) .....  | 29.1x79.8                      |
| DW01308 <sup>a,b,c</sup> Windshield (06-11) .....  | 29.1x79.8                      |
| DD09354-55 Door F/R-L (06-11) .....  | 31.0x35.5                      |
| DB09356 Back Window (06-11) .....  | 15.5x40.0                      |
| <sup>a</sup> May Require Two Person Installation<br><sup>b</sup> Urethane,Dam,Primer - 2.5 Tubes<br><sup>c</sup> Fast-Cure Urethane/Dam/Primer - Quantity 2.5  |                                |
| <b>Western Star</b>  |                                |
| <b>Constellation Series Conventional Cab</b> .....   | <b>2006-2011</b>               |
| DW01440-41 <sup>a,b</sup> Windshield R-L (Paint Band) .....  | 27.4x37.3                      |

| <b>Constellation Series</b>  |                  | <i>(cont.)</i> |
|--|------------------|----------------|
| DW01278-79 Windshield R-L (Gasket Set) .....   | 27.0x37.0        |                |
| DD09039-40 Door F/R-L .....  | 23.0x30.0        |                |
| DT04696 Back Window (High Hat) .....   | 18.0x36.0        |                |
| DT04694 Back Window (Stationary, High Hat) .....   | 17.0x18.0        |                |
| DT04693 Back Window (2 Holes) (Movable, High Hat) .....  | 17.0x18.0        |                |
| <sup>a</sup> Urethane,Dam,Primer - 1.5 Tubes<br><sup>b</sup> Fast-Cure Urethane/Dam/Primer - Quantity 1.5  |                  |                |
| <b>Workhorse</b>   |                  |                |
| <b>FasTrack Step Van</b> .....   | <b>2006-2011</b> |                |
| DW01821 <sup>b,c</sup> Windshield L/Outer (Tempered) .....   | 23.5x34.0        |                |
| DW01650 <sup>b,c</sup> Windshield L/Outer (Tempered) .....   | 21.3x34.0        |                |
| DW01820 <sup>b,c</sup> Windshield R/Outer (Tempered) .....   | 23.5x34.0        |                |
| DW01649 <sup>b,c</sup> Windshield R/Outer (Tempered) .....   | 21.3x34.0        |                |
| DW01676 <sup>b,c</sup> Windshield R-L (93.5" Body Width) .....   | 35.5x45.5        |                |
| DW01648 <sup>b,c</sup> Windshield R-L (86.5" Body Width) .....   | 35.5x42.0        |                |
| DW01677 <sup>a,d,e</sup> Windshield (78.5" Body Width, One-Piece) .....  | 35.5x76.3        |                |
| <sup>a</sup> May Require Two Person Installation<br><sup>b</sup> Urethane,Dam,Primer - 1.5 Tubes<br><sup>c</sup> Fast-Cure Urethane/Dam/Primer - Quantity 1.5<br><sup>d</sup> Urethane,Dam,Primer - 2.5 Tubes<br><sup>e</sup> Fast-Cure Urethane/Dam/Primer - Quantity 2.5 |                  |                |